

Features  
New Artwork

# CYBERPUNK

THE ROLEPLAYING GAME OF THE DARK FUTURE

"Got the  
chips and  
enhance-  
ments—

"Got the  
Attitude  
right—

"Got the  
Metal  
beneath my  
skin—

"I'm chippin'  
in..."

—Johnny  
Silverhand



2. THE 0. SECON 2. 0. EDITION

R. TALSORIAN  
GAMES  
INC.

CP 3002



# CYBERPUNK

**THE ROLEPLAYING GAME OF THE DARK FUTURE**

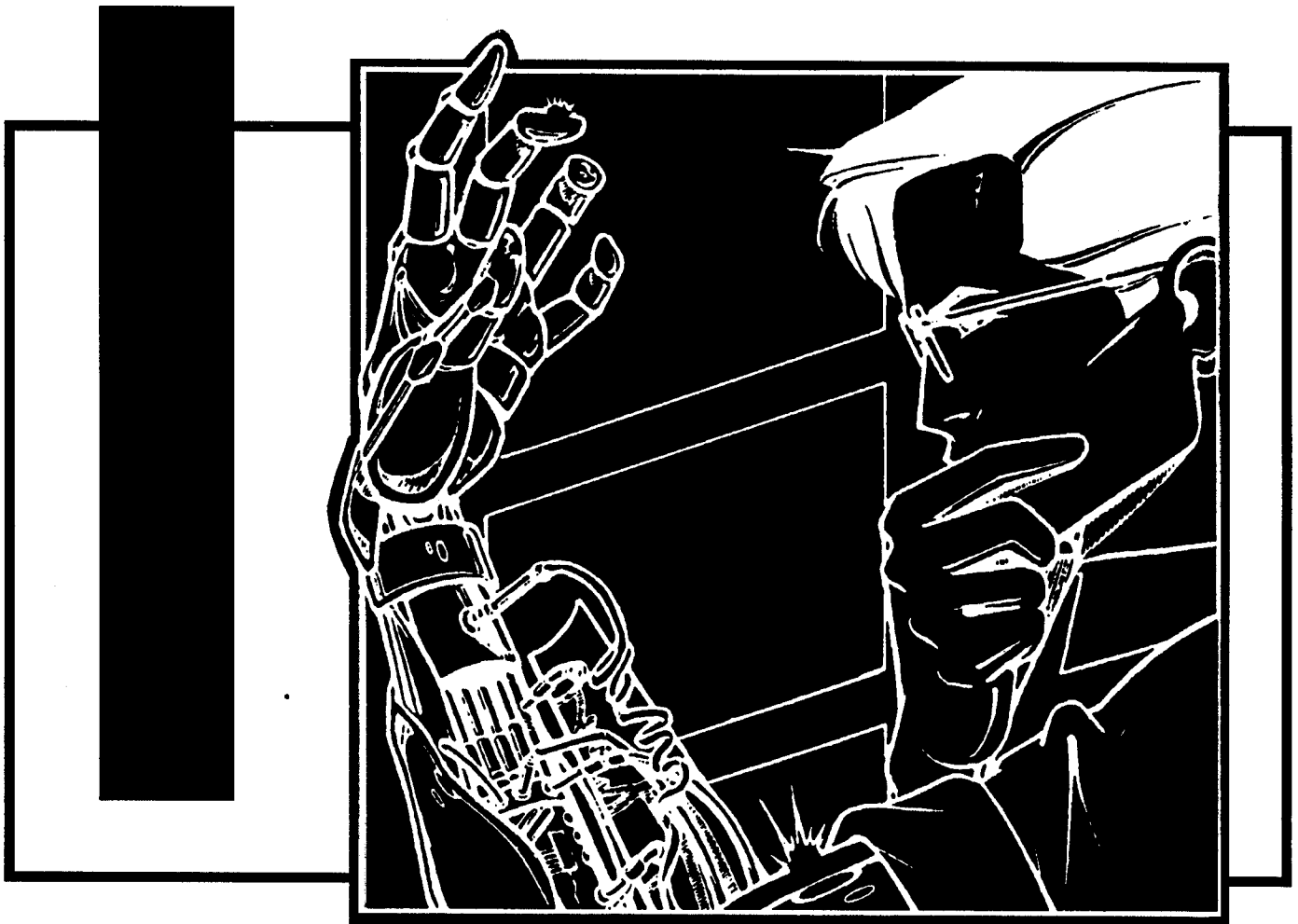

**2.0.2.0**  
THE SECOND EDITION  
**VERSION 2.01**

**R. TALSORIAN  
GAMES  
INC.**

Contains corrections and clarifications to CYBERPUNK 2.0.2.0., Version 2.0, including bound-in version of SCREAMSHEETS adventures and new artwork. For a free CP 2.0.2.0. update to bring your Version 1.0 online with the new data in this version, as well as a free DATA SCREEN correction overlay, just send an SASE to R. Talsorian Games, Inc. P.O. Box 7356, Dept H, Berkeley, CA. 94707.



# CYBERPUNK

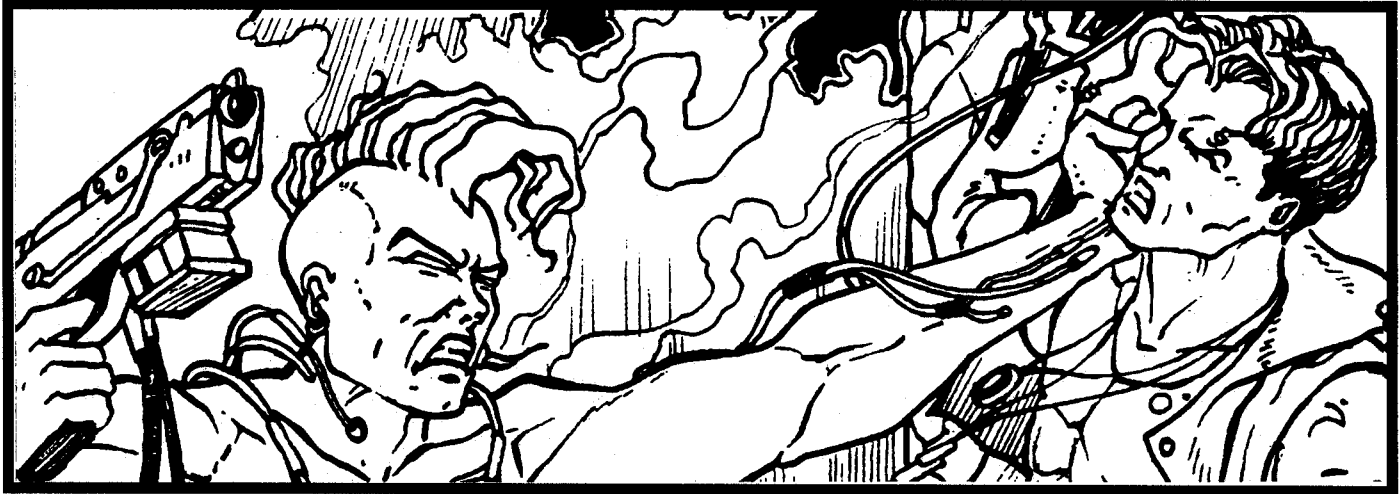

THE SECOND EDITION

## Cast & Crew

### Writers

Mike Pondsmith  
Colin Fisk  
Will Moss  
Scott Ruggels  
Dave Friedland  
Mike Blum (Screamsheets)

### Cover

Doug Anderson

### Illustration

Justin Chin  
Paolo Parente  
Chris Hockabout  
Sam Liu  
Riccardo Crosa  
Angelo Montanini  
Scott Ruggels

Matteo Resinanti  
Mike Hernandez

### Layout & Design

Matt Anacleto  
Mike Pondsmith  
Diana "Fritz" Goldman  
Screamsheets: Janet Piercy  
& Ted Talsorian  
Art Recovery: Mike MacDonald

### Typography

Diana "Fritz" Goldman  
Ted Talsorian

### Editing

Will Moss  
Derek Quintanar  
Mike Pondsmith

Lisa Pondsmith  
Janet Piercy  
Fiddly Bits: Ed Bolme

### Playtesters

Anders Swenson  
Mike Blum  
Chris Hockabout  
Kevin DeAntonio  
Thaddeus Howze  
Barton Bolmen  
Sean Fitzpatric  
Steve Isom  
Lucien Stalls  
Ian Studebaker  
Magnus Seder  
Rob Pruden  
Brian Perry  
Jesse VanValkenburg  
Charlie Moore  
Steven Lorenz  
Eric Huber  
Randy Roosa

**R. TALSORIAN  
GAMES  
INC.**

P.O. Box 7356, Berkeley, CA USA 94706

Copyright © 1990, 1991, 1993 by R. Talsorian Games, Inc. All Rights Reserved. *Cyberpunk*® is R. Talsorian's Trademark name for its adventure game of the dark future. The terms *Netrunner*, *Chromebook* and *Night City* are trademarks of R. Talsorian Games, Inc. All Rights Reserved under Universal Copyright Convention. All incidents, situations, and persons portrayed within are fictional, and any similarity, without satirical intent, of characters living or dead is strictly coincidental.

To Lisa.

*What a long, strange trip it's been!*

CP 3002 ISBN 0-937-279-13-7



# CONTENTS

<b>Soul &amp; The New Machine</b> .....	<b>3</b>	Cyberoptics .....	86	Exotic Fashion .....	121
Roles .....	4	Cyberaudio .....	87	<b>Drugs</b> .....	<b>122</b>
Special Abilities .....	4	Cyberlimbs .....	88	Building Your Own .....	123
Rockerboys .....	6	Cyberlimb Cyberweapons .....	91	<b>Netrunner</b> .....	<b>127</b>
Solos .....	8	Linear Frames .....	91	Geography .....	128
Netrunners .....	10	Body Plating .....	92	Islands of the Net .....	129
Techies12 .....	10	Running Out of Cash .....	93	Regions .....	129
Medias .....	14	<b>Friday Night Firefight</b> .....	<b>96</b>	Long Distance Links .....	131
Cops .....	16	Rounds & Turn Order .....	97	Wilderspace .....	131
Corporates .....	18	Initiative .....	97	NetWatch .....	131
Fixers .....	20	Fast Draw .....	97	Bulletin Boards (BBS) .....	131
Nomads .....	24	Actions .....	98	Net Gear .....	132
<b>Getting Cyberpunk</b> .....	<b>25</b>	More Than One Action .....	98	Interfaces .....	132
Character Points .....	25	Two Weapon Attacks .....	98	ICONS .....	132
Statistics .....	26	Ambushes & Backstabs .....	98	Interface Plugs .....	132
Fast & Dirty Expendables .....	30	Line of Sight/Facing .....	101	Cyberdecks .....	132
<b>Tales From the Street (Lifepath)</b> ...	<b>33</b>	Damage .....	101	Improving Your Deck .....	134
Origins & Style .....	34	Hit Locations .....	101	Deck Options .....	134
Family Background .....	35	Armor .....	101	Programs .....	137
Motivations & Life Events .....	36	Cover .....	102	Live Link Up .....	141
Big Problems, Big Wins .....	37	Body Type Modifier .....	103	Program List .....	142-143
Friends & Enemies .....	38	Wounds .....	103	Running the Net .....	144
Romantic Life .....	39	Stun/Shock Saves .....	104	Security Levels .....	144
<b>Working</b> .....	<b>41</b>	Death Saves .....	104	Tracing .....	145
Skill Checks .....	41	Making Attacks .....	104	Subgrids .....	149
Starting Skills .....	43	Ranged Weapons .....	105	The Menu .....	149
Career Skill List .....	44	Automatic Weapons .....	106	Combat .....	149
Master Skill List .....	45	Unusual Ranged Weapons .....	107	Initiative .....	151
Pickup Skills .....	46	Beam Weapons .....	108	Turns & Actions .....	151
Skill Descriptions .....	46-53	Area Effect Weapons .....	108	Range .....	152
Learning New Skills .....	53	Shotguns .....	108	Movement .....	152
IP Multipliers .....	53	Grenades .....	108	Stealth & Evasion .....	152
Getting More IP .....	54	Flamethrowers .....	108	Attacks Against Systems/Decks ..	152
Inventing New Skills .....	54	Rocket Powered Grenades .....	110	Anti-personnel Attacks .....	153
Reputation .....	54	Missiles .....	110	Anti-IC Attacks .....	153
<b>Getting Fitted For the Future</b> .....	<b>57</b>	Explosives .....	110	Controllers & Utilities .....	153
Starting Funds .....	57	Molotov Cocktails .....	111	Designing Data Fortresses .....	154
Encumbrance .....	59	Melee Attacks .....	111	Playing Artificial Intelligences .....	155
Weapons .....	60	Martial Arts & Brawling .....	111	Fast Fortress Construction .....	164
Weapons List .....	61-62	Dodging .....	112	Programming 101 .....	167
Weapons Descriptions .....	62-63	Parrying .....	112	Virtually There .....	170-174
Old Guns .....	66	Melee Damage .....	112	<b>All Things Dark &amp; Cyberpunk</b> .....	<b>175</b>
Armor .....	67	Monoknives, Mono Katanas & Slice n'	112	Future Shock .....	176-185
Special Equipment .....	67	Dice .....	112	<b>Running Cyberpunk</b> .....	<b>186-189</b>
2020 Gear List .....	68	Vehicles in FNFF .....	112	<b>Never Fade Away: A Cyberpunk</b>	<b>Story/Adventure</b> .....
Gear Descriptions .....	69-71	Vehicle Combat .....	112	190-203	
<b>Putting the Cyber Into the Punk</b> ...	<b>72</b>	Vehicle Damage .....	113	<b>Megacorps 2020</b> .....	204-208
Cyberfashion .....	72	<b>Trauma Team</b> .....	<b>115</b>	Corporate Profiles .....	209-214
Cyberpsychosis .....	73	Stabilization .....	115	<b>Night City</b> .....	<b>215-219</b>
Humanity Costs .....	74	Death State .....	115	Encounters .....	220-221
Cybertechnology .....	75	Healing .....	116	Personalities .....	222-223
Cyberware List .....	76-79	First Aid .....	116	<b>Face of the City</b> .....	<b>224-231</b>
Surgery Codes .....	75	Medical Tech .....	116	<b>Screamsheets</b> .....	<b>232-250</b>
Fashionware .....	80	Speed Healing Drugs .....	117		
Neuralware .....	80	Nanotech .....	118		
Implants .....	83	Elective Surgery .....	118		
Bioware .....	85	Replacement Surgery .....	119		
Cyberweapons .....	85	Trauma Team™ .....	119		
		Body Banks .....	120		
		Vat Grown Tissue Banks .....	120		
		Bodysculpting .....	120		



**ROLES**  
**CHARACTERS**  
**LIFEPATH**  
**TASK & SKILLS**  
**WEAPONS**  
**ARMOR**  
**GEAR**  
**CYBERWEAR**  
**COMBAT**  
**MEDICAL**  
**NETRUNNING**

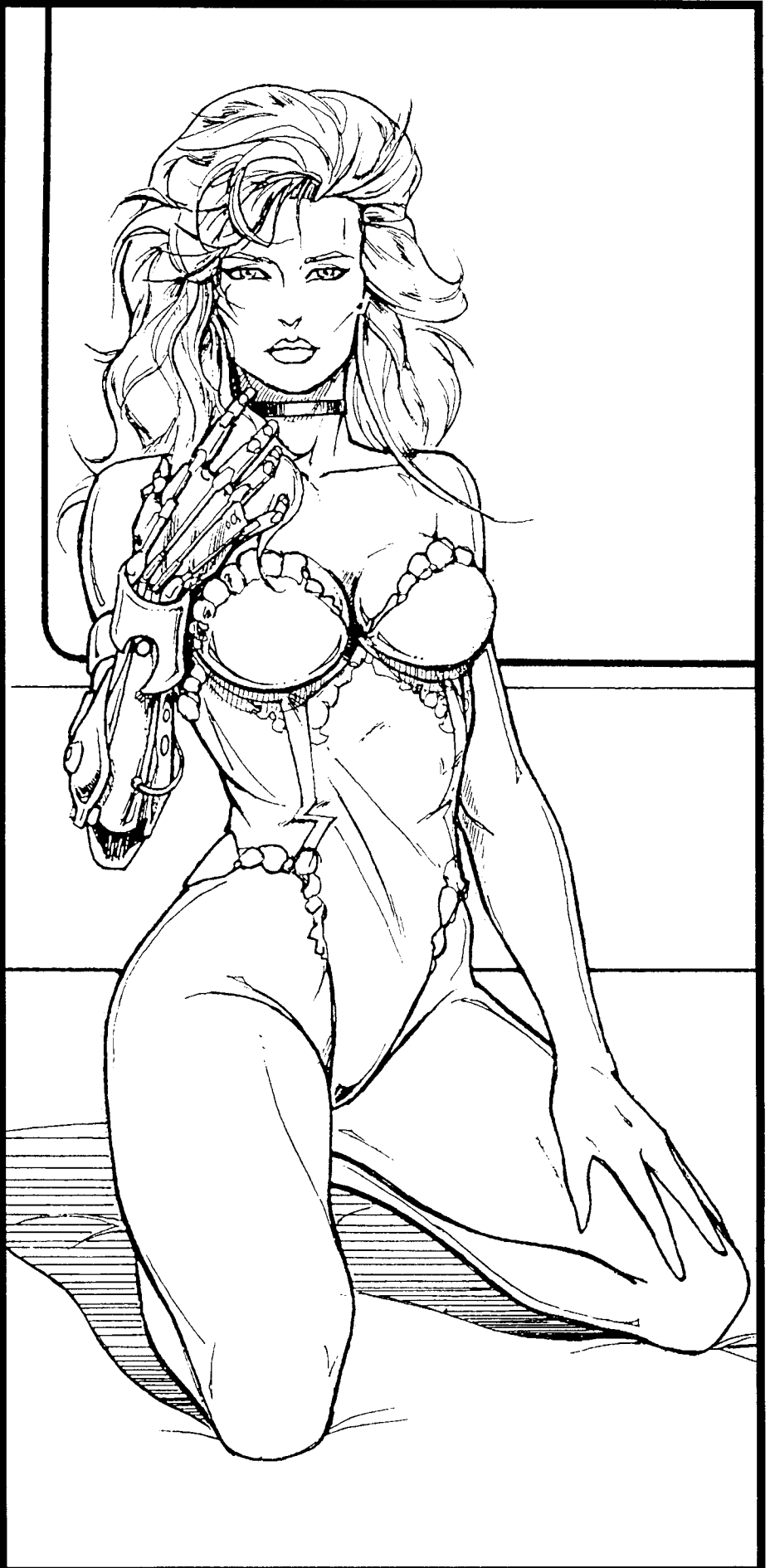

**VIEW**  
**FROM**  
**THE**  
**EDGE**



THE VIEW FROM  
THE EDGE

"I'm not a man /or a machine.  
I'm just something in between.  
I'm all love / a dynamo  
So push the button and let me go."  
Lovin' Every Minute of It  
1984 Zomba Enterprises Inc. (ASCAP)

So you wanna be a *Cyberpunk*? Or maybe just look like one?

Before you pitch off your sleepmat and jump in, there's a few things we need to tell you. First of all, the name. *Cyberpunk* comes from two words. *Cyber*—from the term cybernetic, or a fusion of flesh and machine technology. *Punk*—from an early 1980's rock music style that epitomized violence, rebellion and social action in a nihilistic way. The term was popularized in the Pre-Collapse days by a group of writers who specialized in writing science fiction with this kind of techno-melange. Their works featured a streamlined blend of rock, pop, sex, drugs and the highest, hippest technology—usually grafted onto your body somewhere. The archetypal cyberpunk heroes of the 80's ranged from technobarbarians roaming a Postholocaust world, to cyberchipped jet setters with designer bodies.

Of course, from our enlightened viewpoint here in 2020, this all looks pretty dated. After all, you probably accessed this article from your personal database 'comp. You used a Kiyoshiru 1300A interface cable with a direct link from your wristplugs. You're used to hard-wiring into the appliances to make coffee, "studding" into the 'Benz to drive down to the corner store. But understand—in 1987, this was all considered pretty visionary stuff. No one had plugs. You couldn't dial Luna on the cellular. Designer drugs were illegal. You could walk down most city streets without an armor jacket. There wasn't even a Net.

Now we know better. History books can tell you in detail about the Crash of 1994, when the Euro-Combines established the World Stock Exchange and the economies of the United States and Old Sov Russia collapsed.

In those days, both were ranked as superpowers, instead of a couple of overarmed second-raters waving nuclear weapons around under the watchful eye of the EuroSpace Defense Agency. As long as the Tycho massdrivers are ready to throw rocks at Moscow and Washington, we'll probably avoid having the nuclear war everyone's been expecting since 1944. After all, rocks are cheap.

Now, of course, everything's more or

**As a Cyberpunk, you grab technology by the throat and hang on. You've got interface plugs in your wrists, weapons in your arms, lasers in your eyes. biochip programs in your brain. You become the car you drive, the gun you shoot...With cyborged fingers you pick computer locks; with enhanced senses, you see into the Future.**

SECTION

# 1 SOUL & THE NEW MACHINE

**The world of Cyberpunk is a violent, dangerous place, filled with people who'd love to rip your arm off and eat it. The traditional concepts of good and evil are replaced by the values of expedience—you do what you have to do to survive. If you can do some good along the way, great.**

**But don't count on it.**

*Cyberpunk* characters are survivors in a tough, grim world, faced with life and death choices. How they make these choices will have a lot to do with whether they end up as vicious animals roaming a ruined world, or retain something of their basic humanity. *Cyberpunk* characters are the heroes of a bad situation, working to make it better (or at least survivable) whenever

they can. Whether it takes committing crimes, defying authority or even outright revolution, the quintessential *Cyberpunk* character is a rebel

**"Always take  
it to the  
Edge. It's the  
Cyberpunk  
way."**

**—Johnny  
Silverhand**

with a cause. As a *Cyberpunk* role-player, it's up to you to find that cause and go to the wall with it.

This is the essence of *Cyberpunk*—playing your character with the proper disaffected, cynical-yet-idealistic style. Whether you're a biker with leathered skin and metal claws, or a debutante in satin sporting the latest in designer cyberoptics, you're going to need a certain panache—a certain flair, in portraying yourself. To achieve the essence of the 2000's, you need to master three concepts:

less run by the Corporations, which are pretty much governments in themselves. You can go anywhere on one passport—one worldism at its best. The currencies of most nations are stabilized to each other, and the Eurodollar is a world currency. Hardly anyone complains anymore about Corporate Lifetime Contracts or the abolition of unions. It's the price of living in a stable, safe society, right?

After all, you *could* be living in the Projects. Sixteen people to an apartment, sharing ration chips every week to buy food, with eight thousand apartments per city block? Sure, it isn't the best life, what with the booster-gangs roaming the Malls and the major-league crime problems, but it beats actually being on the Street. At least the mega-arcologies have cops (okay, rented Corporate cops, but it's easier than fronting the euro for your own personal Solo!). Besides, the medians make sure that every apartment has direct cable access to TV, radio and sensory feed, so there's always something to do on a Saturday night.

Where were we? Oh yeah—you want to be a *Cyberpunk*.

Here's more background for you to think over. When the grand old Masters of the Movement first started writing the *cyberpunk* genre, they assumed that most of the things they wrote about would either never happen or would happen in the far future. No one knew that the West Germans were already developing "organic" circuitry in the late 1980's, or that the United States Air Force was developing mentally controlled weapons systems. Synthetic myomar muscle fibres were just starting to be used to control prosthetics, and very few people could project ahead into the 1990's when organic chipped arms and legs would be possible. There were a few primitive experiments with bioengineering—things like Frostban™ and a few new types of corn—nothing like the bio-engineered animals that we'll use to terraform the Martian colonies.

It took about fifteen years for the newtech to catch up with the vision. First, the military started using cybertechnology to create "perfect soldiers" and pilots. Some of the spin-off led to prosthetic limbs, eyes and other body parts. Organic circuitry led to direct hookups between men and computers. Combined with advanced telecommunications technology and satellite downlinks, the basis for the now planetwide Net, was established. As each new technological advancement slammed into place, a sort of cultural technoshock set in.

### 1) Style over Substance

It doesn't matter how well you do something, as long as you look good doing it. If you're going to blow it, make sure you look like you planned it that way. Normally, clothes and looks don't matter in an adventure—in this world, having a leather armor jacket and mirrorshades is a serious consideration.

### 2) Attitude is Everything

It's truth. Think dangerous; be dangerous. Think weak; be weak. Remember, everyone in the 2000's is carrying lots of lethal hardware and high-tech enhancements. They won't be impressed by your new H&K smartgun unless you swagger into the club looking like you know how to use it—and are just itching for an excuse.

Never walk into a room when you can stride in. Never look at someone unless you can make it your best "killer" look. Use your best "I'm bad and you aren't." smile. Don't sit around the flat or cube waiting for the next job. Get on out and hit the clubs and hangouts. Make sure you're where the party starts.

### 3) Live on the Edge

The **Edge** is that nebulous zone where risk takers and highriders go. On the Edge, you'll risk your cash, your rep, even your life on something as vague as a principle or a big score. As a *cyberpunk*, you want to be the action, start the rebellion, light the fire. Join great causes and fight for big issues. Never drive slow when you can drive fast. Throw yourself up against danger and take it head on. Never play it too safe. Stay committed to the Edge.

### ROLES: The Core of CYBERPUNK Role-playing

The world of *Cyberpunk* is a combination of savage, sophisticated, modern and retrograde. Fashion-model beautiful Techies rub shoulders with battle armored road warriors, all of them making the scene in the hottest dance clubs, sleaziest bars and meanest streets

this side of the Postholocaust. Each character in this world is playing a **Role**—a face that person projects to the outside world as the real thing. There are 9 Roles in *Cyberpunk*: **Rockerboys, Solos, Netrunners, Corporates, Techies, Cops, Fixers, Medias, and Nomads.** As a *Cyberpunk* player, you must select one role for your character.

### SPECIAL ABILITIES

**Special Abilities** are skills usable only by specific character Roles; for example, Rockerboys have the Special Ability of *Charismatic Leadership*, which represents the vast amount of power they have over their legions of fans. When using a Special Ability, you will add its value to the specific stat as if it were a skill.

**Rockerboy Special Ability: Charismatic Leadership.** This skill allows the Rocker to sway crowds equal to his ability level squared, times 200.

**Solo Special Ability: Combat Sense.** Added to all *Initiative* and *Awareness* checks, this makes the Solo the fastest reacting person in a situation.

**Netrunner Special Ability: Interface.** This Skill reflects the Netrunner's ability to manipulate Interface programs, and is the skill used when operating *Menu* functions such as *Locate Remote, Run Software, Control Remote, LDL Link, Load, Create and Delete.* Other players can enter the Net, but can't use the Menu.

**Techie Special Ability: Jury Rig.** This general repair skill allows the Techie to temporarily repair or alter anything for 1D6 turns per level of skill.

**Medtech Special Ability: Medical Tech.** This is the skill used to perform major surgery and medical repairs.

**Media Special Ability: Credibility.** The ability to have people believe what you are saying while in your on-air persona.

**THE RULES:**  
**1) Style Over Substance.**  
**2) Attitude is Everything.**  
**3) Always take it to the Edge.**  
**4) Break the Rules."**  
—Ripperjack



**Cop Special Ability: Authority.** The ability to intimidate or control others through your position as a lawman.

**Corporate Special Ability: Resources.** This represents the Corporate's ability to command corporation resources. It is used as a persuasion skill, based on the scale of resources requested.

**Fixer Special Ability: Streetdeal.** The ability to locate people, information, etc. This is a higher form of *making a connection* (Lifepath, pg. 27); instead of knowing only one person, you have connections everywhere. In game play, a successful use of Streetdeal allows you to locate and acquire a desired person, place or thing.

**Nomad Special Ability: Family.** This allows the Nomad to call in as many Family members to aid him as his current *Family Ability* level x 2.

### A SPECIAL NOTE ABOUT THIS PRINTING

Ahem! It's NOT a Third Edition. In this reprint, we've taken extra time to fix all the corrections and typos we could find, plus squared away a few of the problems and inconsistencies. But these rules are the same rules you've been using since the 2020 edition of the game was printed.

But there is **one big change**— the art. One of the great joys of publishing international editions is that sometimes your licensors come up with cool stuff you really wish *you'd* put into your game. The new art in this printing is from the great guys at *Stratelibri*, who publish the Italian *Cyberpunk* (many thanks to Paolo, Matteo, Riccardo, Angelo, Silvio and of course, Giovanni). We hope all of you out there like it as much as we did!

—Maximum Mike

**Technoshock:** When technology outstrips people's ability to comprehend or fit it into their lives. Suddenly, people freak out. They get irrational; violent. Families shatter; relationships tear apart. People feel helpless in the face of the Universe. Eventually, the whole society grinds to a halt, the victim of a mass psychosis. That's what we now call the Collapse.

There were three major responses to technoshock. The vast majority of people, their lives uprooted and changed by the advancements, sat passively waiting for their leaders to tell them what to do next. One smaller group tried to turn back the clock, founding the basis for what we call the Neo-Luddite movement. The remaining group—they decided to hit the future head on. With the old 1980's visionary writings as their guide, they established the movement we now call *Cyberpunk*.

Okay, so now you're ready.

As a *cyberpunk*, you grab technology by the throat and hang on. You're not afraid to check out the newest in "enhancements", cybertech and bio-engineering. You've got interface plugs in your wrists, weapons in your arms, lasers in your eyes, biochip programs in your brain. You become the car you drive, the gyro you fly, the guns you shoot. You dive headfirst into the Net, using your mind to hurtle at lightspeed all over a vast network of Data Fortresses and Artificial Intelligences. With cyborged fingers you pick computer locks; with enhanced senses, you see into the Future.

*Cyberpunk* is also an attitude. You wear the most "in" clothes, know the right people, and follow the right crowds. You plan your crimes in the most select clubs and bars; your enemies are Corporate armies, cyborg bike gangs, power-armored assassins and computer-wired Netheads. Your weapons are nerve, street-smarts, bravado and the Minami 10 smartgun on your hip.

Are you ready now? Of course you are. You can't wait.

Now you're *Cyberpunk*.



# CYBERPUNKS

# ROCKERBOYS

**REBEL ROCKERS WHO USE MUSIC AND REVOLT TO FIGHT AUTHORITY**

If you live to rock, this is where you belong. Rockerboys are the street poets, social consciences and rebels of the 2000's. With the advent of digital porta-studios and garage laser disk mastering, every Rocker with a message can take it to the street; put it in the record stores, bounce it off the comsats.

Sometimes, this message isn't something the Corporations or the Government wants to hear. Sometimes what you say is going to get right in the faces of the powerful people who really run this world. But you don't care, because as a Rockerboy, you know it's your

place to challenge authority, whether in straight-out protest songs that tell it like it is, or just by playing kick-ass rock n' roll to get the people away from the TV sets and into the Streets. You have a proud history as a Rockerboy—Dylan, Springsteen, Who, Elvis, the Stones—the legions of hardrock heroes who told the truth with screaming guitars and gut-honest lyrics.

As a Rockerboy, you have the power to get the people up—to lead, inspire and inform. A song from you can give the timid courage, the weak strength, and the blind vision.

Rockerboy legends have led armies against Corporations and Governments. Rockerboy songs have exposed corruption, brought down dictators. It's a lot of power for a guy doing gigs every night in another city. But you can handle it. After all—you came to play!

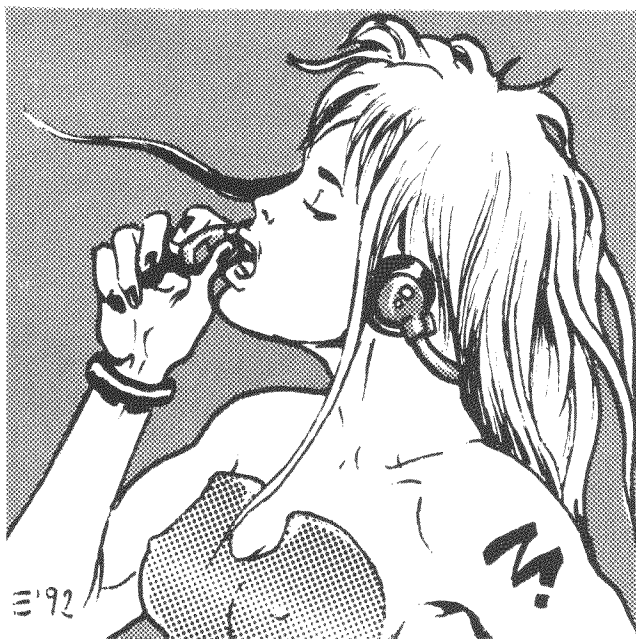

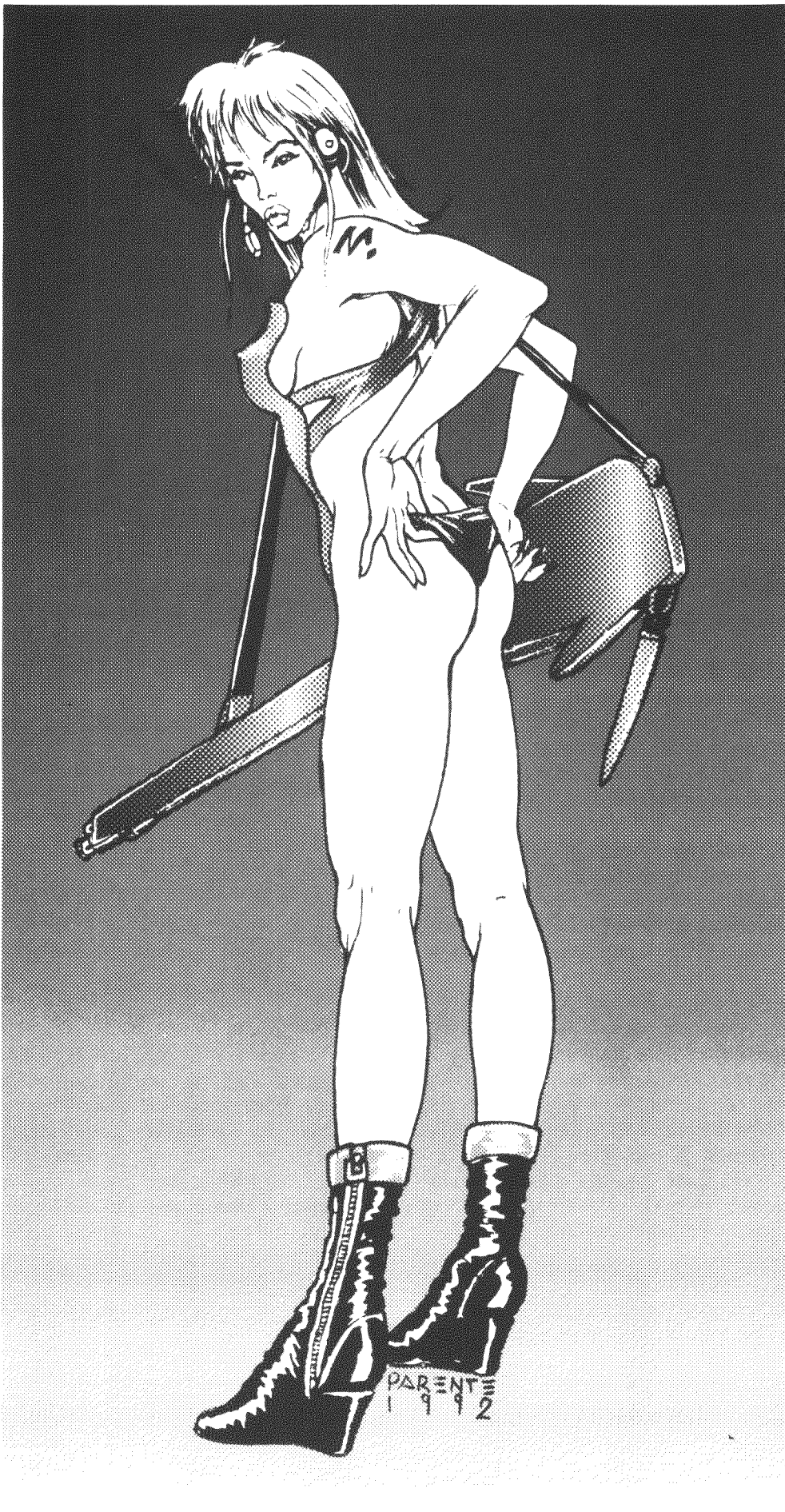

*"I always knew what I had to do. It was really obvious. There were these scum out there who were messing with the world. They were killing people, raping the land, and lying in our faces when we caught 'em.*

*"So I decided I had to put the heat on 'em and make 'em sweat. That's why I became a Rockerboy.*

*"Music always gets hammered down to the Three A's. Axe, Attitude and Audience. Me, I had an Axe and an Attitude. All I had to do was get the third one..."*

—Kerry Eurodyne,  
Rockerboy.

## CYBERPUNKS

## SOLOS

**HIRED ASSASSINS, BODYGUARDS, KILLERS,  
SOLDIERS**

You were re-born with a gun in your hand—the flesh and blood hand, not the metallic weapons factory that covers most of your other arm. Whether as a freelance guard and killer-for-hire, or as one of the Corporate cybersoldiers that enforce business deals and the Company's "black operations", you're one of the elite fighting machines of the *Cyberpunk* world.

Most Solos have put in military time, either in a Corporate army or in one of the Government's continual "police actions" around the world. As the battle damage piles up, you start to rely more and more upon hardware—cyberlimbs for weapons and armor, bio-program chips to increase your reflexes and awareness, combat drugs to give you that edge over your opponents. When you're the best of the best, you might even leave the ranks of Corporate samurai and go *ronin*—freelancing your lethal talents as killer, bodyguard or enforcer to whoever can pay your very high fees.

Sounds good? There's a price—a heavy one. You've lost so much of your original meat

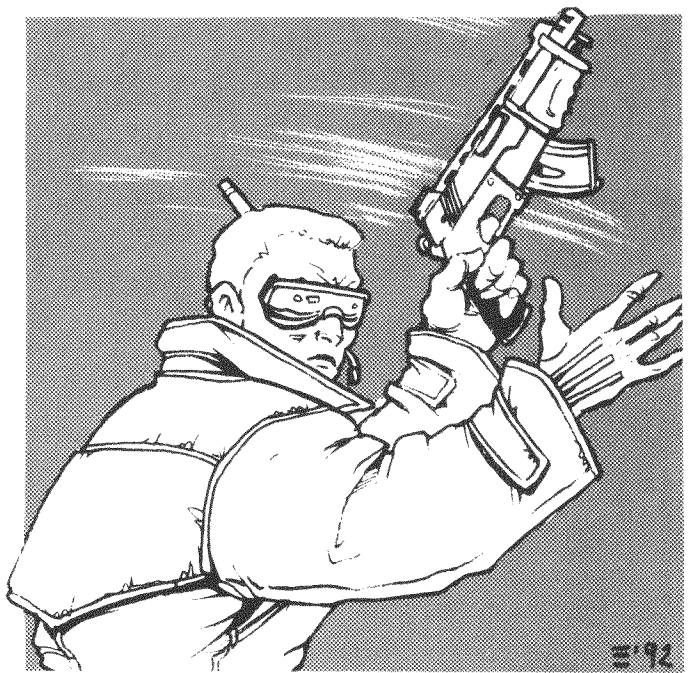

body that you're almost a machine. Your killing reflexes are so jacked up that you have to restrain yourself from going beserk at any moment. Years of combat drugs taken to keep the edge have given you terrifying addictions. You can't trust anyone—your mother, your friends, your lovers—no one. One night you sleep in a penthouse condo in the City—the next in a filthy alley on the Street. But that's the price of being the best.

And you're willing to pay it. Because you're a Solo.



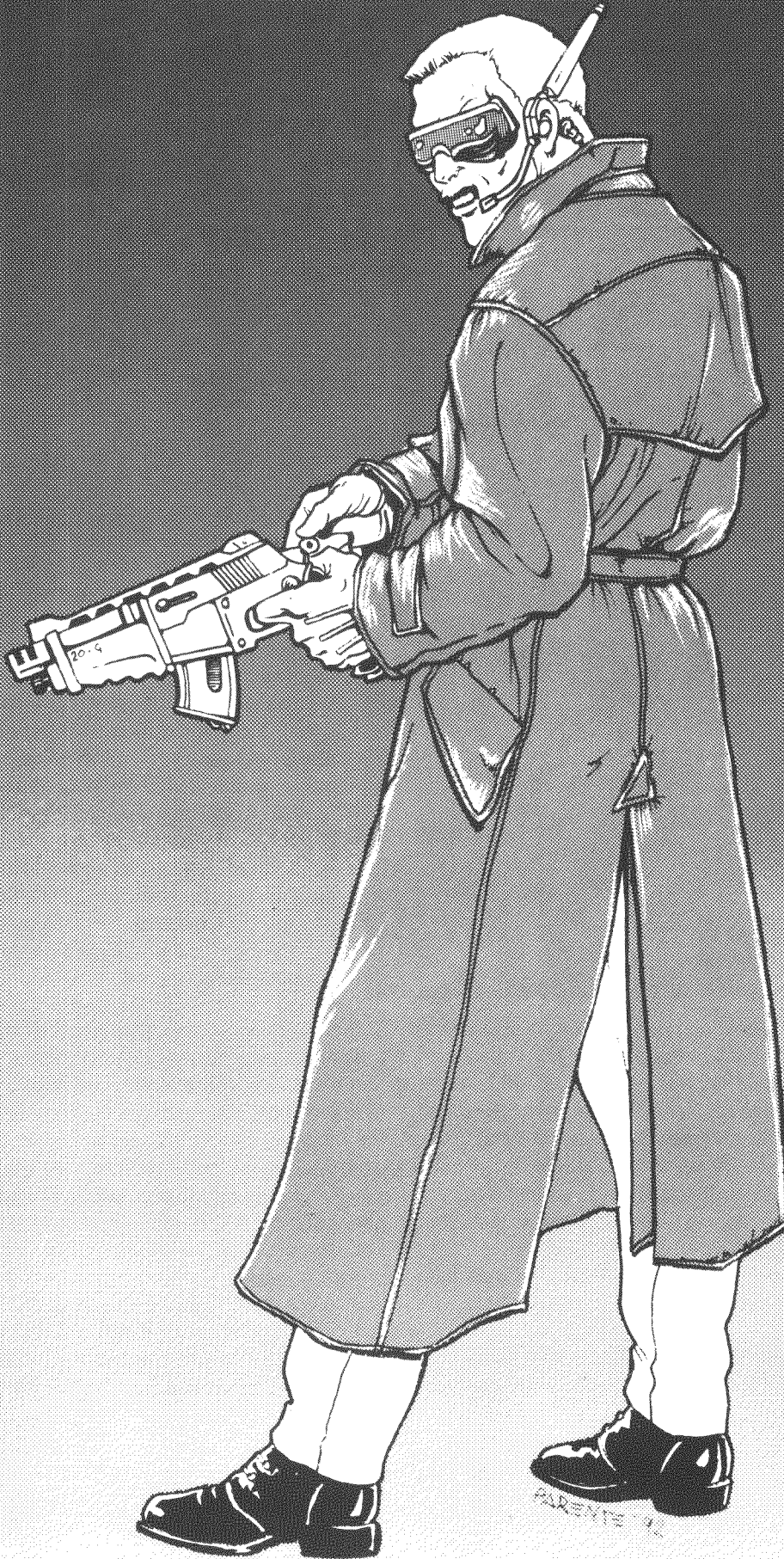

**"After I got out of the Army, I had this problem. I was good at what I did, but no one was hiring. I mean, what do you do when you're a highly trained killer with a background in demolitions? Read the want ads?"**

**"After a few months on the Street, I got into a dustdown with a local Booster lord. I flatlined him and went back to my drink. Within ten minutes, the recruiter from Milltech came up to me and dropped a business card..."**

**"Now I'm a Company man. The pay's good, the Work steady, and they pay for my spare parts. So far, I'm still alive."**

**So far, so good."**

**—Morgan Blackhand**

# CYBERPUNKS

## NETRUNNERS

**CYBERNETIC COMPUTER HACKERS**

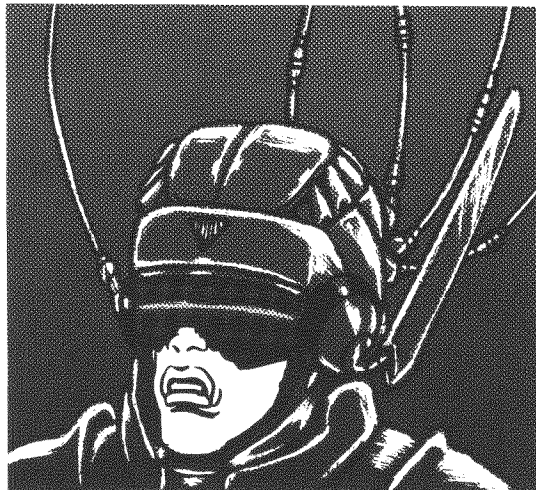

At three, your parents bought you an old Apple IV GS with a Radius 241 wall screen, and your life was changed. By fifth grade, you'd already mastered everything the school computer literacy lab could throw at you—you were already using C and META-LINGUA to crack into the district's mainframe and change your grades. When you were thirteen, you shifted enough funds out of unprotected TransAmerican Bank accounts to finance your first neural interface plugs.

Now, nothing can stop you. With your direct mental link to the computer, you can plunge

headfirst into the dizzying data-winds of the Net; the worldwide telecommunications system that joins humanity together. As an electronic wraith, you are the ultimate "hacker", your brain wired into special modems and computer links. You slip into the "hardest" mainframe systems with ease. Your defense and offense programs are arrayed at a touch of your mental fingertips—a quick jolt of Demon or Vampire and the data fortresses fall. EBM. ITT. Sony-Matsushita-Ford. You've tackled them all, buying, trading and selling their deepest secrets at will.

Sometimes you uncover important things—Corporate treachery or deadly secrets. But that's not why you Netrun. You live for the new program, the next satellite downlink—the next piece of hot data that comes your way. It's only a matter of time, you think—every year, the counter intrusion programs get better, the Artificial Intelligences smarter. Sooner or later, a faster program or programmer's going to catch up; reach out with electronic fingers through your interface plugs, and stop your heart. But time's on your side, and until the ride runs out, you'll be there, barebrained and headfirst in the Net.



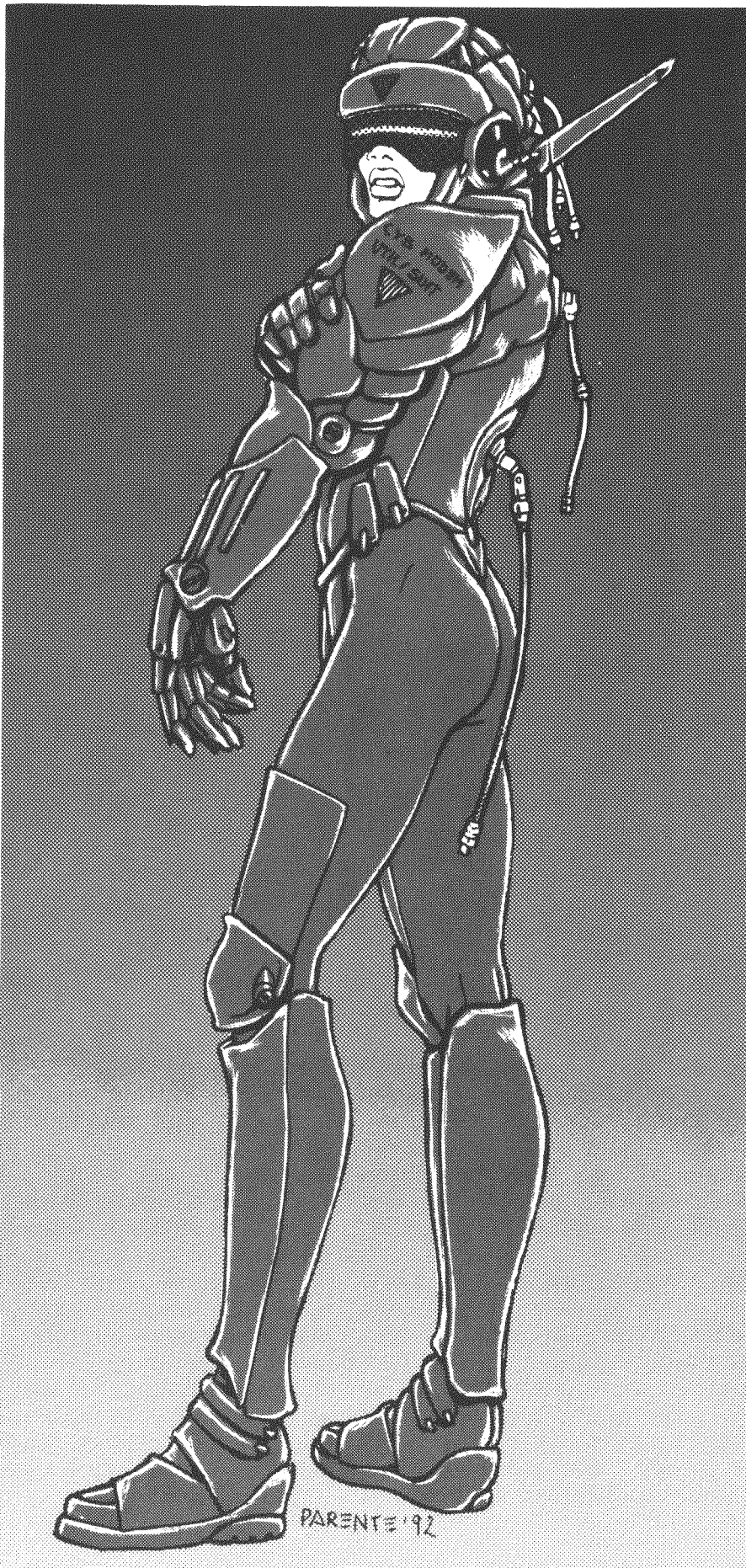

***"You guys who live in Realspace; you move so slow. Me, I like Netspace. It moves fast. You don't get old, you don't get slow and sloppy. You just leave the meat behind and go screamin'.***

***"First system I ever hit, I think they had some weeflerunner playin' Sysop for them. I burned in, jolted the guy with a borrowed Hellbolt, and did the major plunder action all over the Data Fortress.***

***"Somewhere out there is a guy with half his forebrain burned out. I wonder if they ever found the body. I wonder if they'll find mine the same way..."***

**—Spider Murphy**



## CYBERPUNKS

## TECHIES

## RENEGADE MECHANICS AND DOCTORS

You can't leave anything alone—if it sits near you for more than five minutes, you've disassembled it and made it into something new. You've always got at least two screwdrivers and a wrench in your pockets. Computer down? No problem. Hydrogen burner out in your Metrocar? No problem. Can't get the video to run or your interface plugs feedbacking? No problem.

You make your living building, fixing and modifying—a crucial occupation in a technological world where no one person really knows how half the stuff works. You can make some good bucks fixing everyday stuff, but for the serious money, you need to tackle the big jobs. Illegal weapons. Illegal or stolen cybertech. Corporate espionage and counterespionage gear for the big boys' "black operations". Neat little gadgets like thermite bombs and and hunter-killer robots for the occasional "termination."

If you're any good, you're making a lot of money. And that money goes into new gadgets, hardware and information. You'll buy almost any new thing—because it might have a dozen side applications you can use. Of course, your black market work isn't just making you friends—it's also racking you up an impressive number of enemies as well; people who've run into

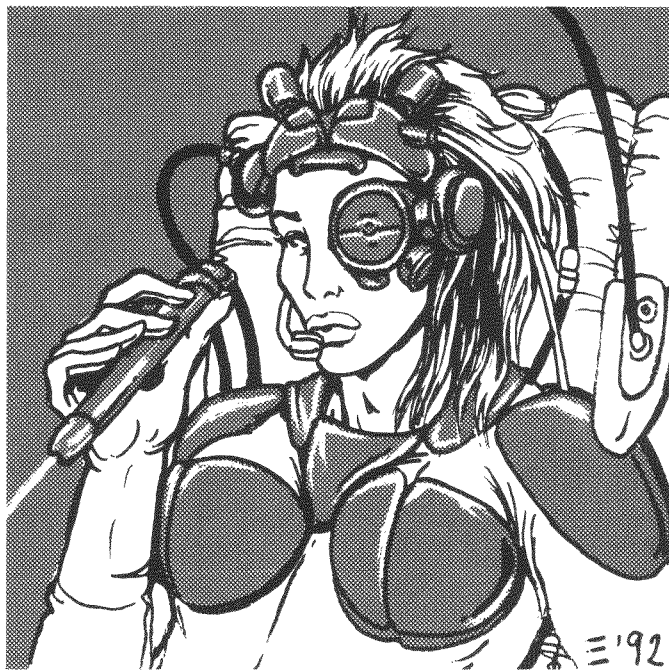

your handiwork and resented it. So you'll invest a lot in defense systems and, if really pushed to the wall, call in a few markers on a Solo or two.

Your cousin down the street is just like you, but he's a **Medtechie**. In a world where half of medicine is related to mechanics, it makes sense. He can do a black market surgical technique faster than you can fix a toaster, and the Solos are always running to him to patch up wounds or install new illegal cybernetics. He's got a lot of the same problems you have, but he's hoping his new job with Trauma Team Inc.™ will loosen things up. You hope he's right. You may be needing his services sooner than you think.

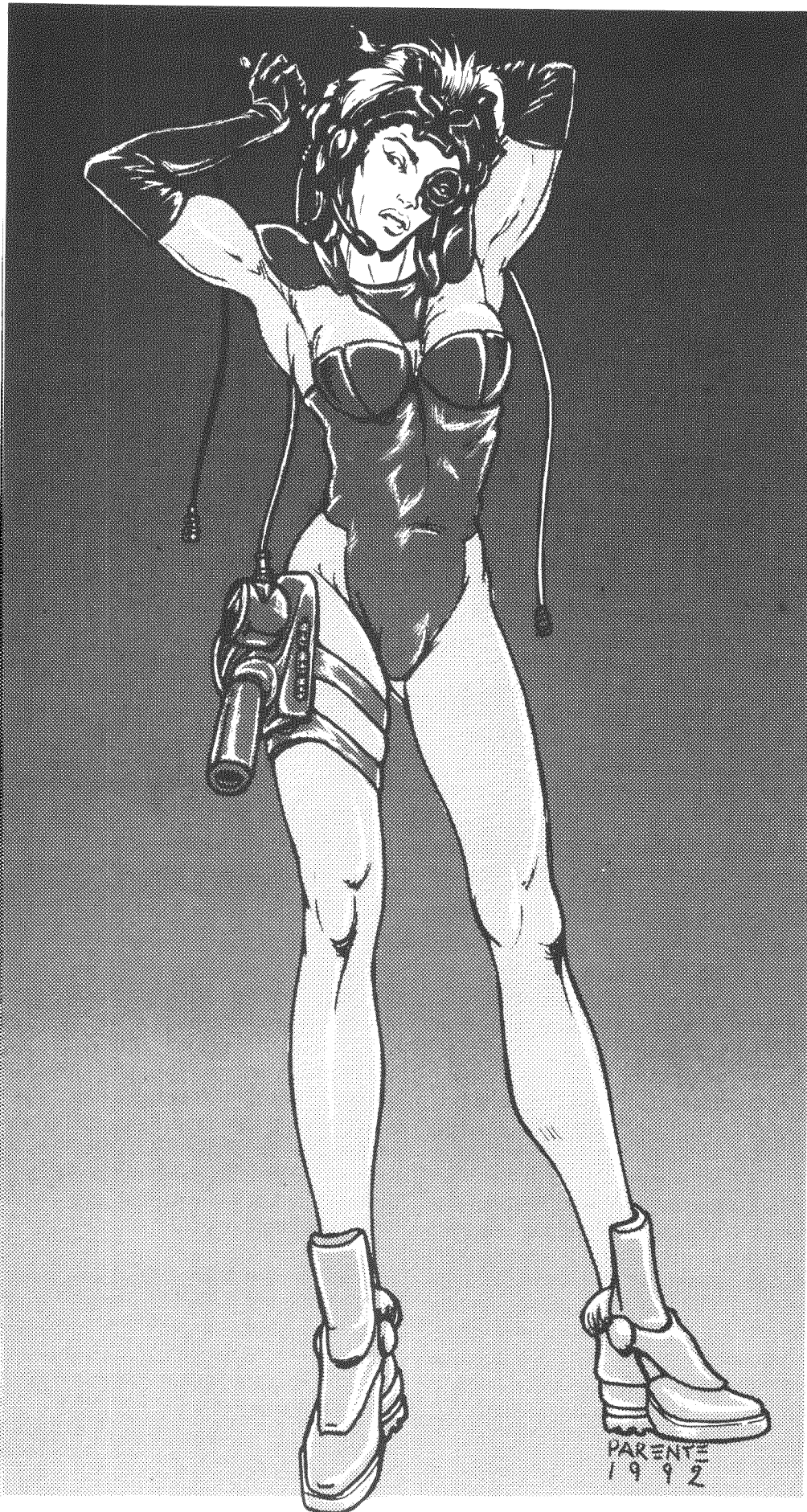

***"So you want me to build a delay switch into the thing? And you don't care about the explosion radius?"***

***"No problem. At least you got a simple job. Last guy in here, he wanted me to build him a cyberhand that had a built-in ...aw, frack, you don't wanna know. People want the weirdest stuff these days..."***

***"I hear with the new cyberwear they're coming up with in Chiba, you're gonna be able to cram your body with more options than a frackin' Mercedes aerodyne...No problem. If you can get parts, I can fix it. Count on it, chombatta."***

**—Mister Ice  
Head of Design  
Technix, Inc.**

# CYBERPUNKS

## MEDIAS

### NEWSMEN AND REPORTERS WHO GO TO THE WALL FOR THE TRUTH

They're bending the truth out there. And you're going to stop them. Someone has to do it. The Corporations rule the world. They dump toxics, destabilize economies and commit murder with equal impunity. The Government won't stop them—they own the Government. The only thing between the Corporations and world domination is the Media. And that's you.

You've got a videocam and a press pass—and you're not afraid to use them. You're a national figure, seen nightly on a million TV sets worldwide. You've got fans, contracts and your own Corporation backing you. They can't make you disappear. When you dig down for the dirt and slime the corrupt officials and Corporate lapdogs try to cover up, you can dig deep. The next morning, you can put the details of their crimes all over the screamsheets and vidscreens. Then the Government has to act.

A week ago, you followed a hot lead and discovered a medical corporation dumping illegal drugs on the Street. This week, you're uncovering a secret Corporate war in South America—a war with jets, bombs, and cybertroops that's killed almost seven thousand innocent people. Each new story you get to the air is one more blow for freedom and justice. Not to mention ratings.

It isn't easy. They've tried to pressure your



Mediacorp dozens of times. You've had stories suppressed—once, Corporate pressure forced them to cancel your news show. Each time, you went to the top, backed by your news director and your crew, and fought to get the story out. Three or four times, they tried to kill you—that's why your backup's a crack Solo bodyguard and you've got one of the top 'Runners in the business digging through the Net to back your stories. You have to be good, or else.

Your 'Runner's just phoned in with a hot lead. He's found a line on twenty tons of illegal weapons being shifted to a port in Bolivia—possibly nuclear. You grab your gear and flag your backup. You're going to break those bastards.

This time, for sure.





*"Okay, so it's dangerous. Look, I'll tell you something. When I was a kid, I used to watch those reporters on the TV news. They wore those chill trenchcoats and were always broadcasting from some exotic place like Mozambique or Saigon. They went right into the Central American warzones with the cybergrunts, and they got the story even when the shooting was maximally fierce.*

*"That's the part I like; the danger."*

—Lyle McClellan,  
Network 54

## CYBERPUNKS

## COPS

## MAXIMUM LAWMEN ON MEAN 21ST CENTURY STREETS

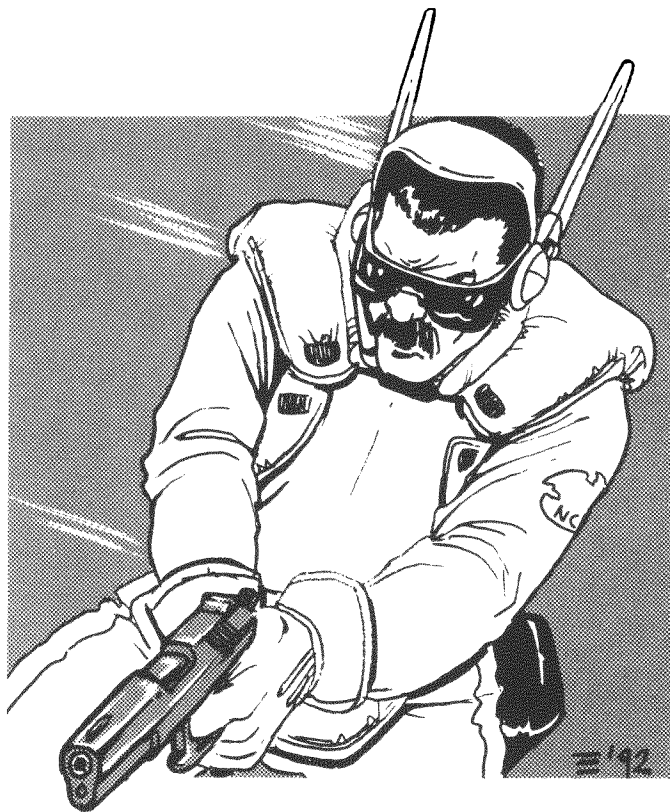

In the old days, they only used to shoot at cops. Now you're lucky if you just take a slug. The Street is mean these days, filled with new drugs, new gangs, and new weapons that make an M-16 look like a kid's toy. If you're on a City Force, you know how bad it is. You're carrying at least four high caliber weapons, most of them full-auto types, wearing a Kevlar vest that'll stop 850 ft/lbs per square inch—and you're still outgunned and outflanked. Half the gangs are cyber to begin with—super speed, super reflexes, can see in the dark, carry weapons in their arms...The other half are freelance Corporate mercs—gangs hired by the Corps to enforce their policies on the Street. And there you are—a beat cop or detective in an

armored squadcar, patrolling this jungle with the heavy predators.

The Corporate Cops—now that's the life. Heavy weapons, full combat armor, Trauma Team™ backup, AV-4 assault vehicles and gyrocopters with miniguns. But they only patrol the sectors of the City that the Government's licensed them for. The nice, clean sectors full of new office buildings and fancy restaurants—where no jacked up psychopunk is going to ever go on a killing spree with an AK-47. You get the bad sections. Burned out buildings and abandoned

cars, where every night is a new firefight and another great opportunity for a messy death.

If you're really unlucky, you might draw PsychoSquad detail. PsychoSquad guys get the job of hunting down heavily armed and armored cyborgs who've flipped out. Sure, the PS guys have access to railguns, gyros and AVs. But a cyberpsycho can walk through machine gun fire and not feel it. A lot of the Psycho Squad detectives are crazy themselves. They load up with boosted reflexes, get some monstrously huge guns, and go hunt the cyborgs solo. But you're not that crazy.

Yet.





***"Drop it, punk. I don't wanna hear your life story, and I don't care what Society did to you. I just wanna see that gun hit the floor. Now..."***

***—Before I give you an extra nostril.."***

***—Sgt. Max Hammerman  
NCPD***



## CYBERPUNKS

## CORPORATES

**SLICK BUSINESS RAIDERS AND MULTI-MILLIONAIRES**

In the old days, they would have called you a yuppie—a hard driven, fast-track MBA on his way up the Corporate ladder. Sure, it's selling your soul to the Company, but face it; the Corporations rule the Cyberpunk world. They control governments, markets, nations, armies—you name it. And you know that whoever controls the Corporations controls everything else.

Right now, your life as a junior executive is anything but easy. There are guys underneath you who'd kill for a shot at your job. There are guys over you who'd kill to keep you out of their jobs. And they're not kidding about the killing—every up and comer in the Corporation has his own crew of Solos and Netrunners to cover his pet projects. Sabotage? Constantly. Bribery? Routine. Blackmail? Common. Promotion by assassination? Always a possibility. The stakes are that high—one slip and you could be out on the Street with the rest of the trash. Or dead.

And the projects your supervisors give you! Some are pretty straightforward; design a new productivity schedule for the Corporation's medical subsidiary. Some are pretty raw—send a "black operations" team into the City to spread a designer plague so the Marketing team can clean up selling the vaccine. Last week, you led a mixed team of



Solos, 'Runners and Techies on a headhunting run to kidnap a researcher from a rival company. The week before, your project was to steal plans for a new suborbital shuttle from the EuroSpace Agency (so that the Aerospace Division could copy the design and sell it to the Soviets).

You told yourself you joined the Corporation to make it a better place—work from the inside, you said. But now you're not so sure. Your ideals are a little tarnished and things are getting pretty bleak. But you can't worry about ethics now. You've got a report due in an hour, and it looks like that guy in Sales is planning to ice your database for good. You're gonna ice him first.

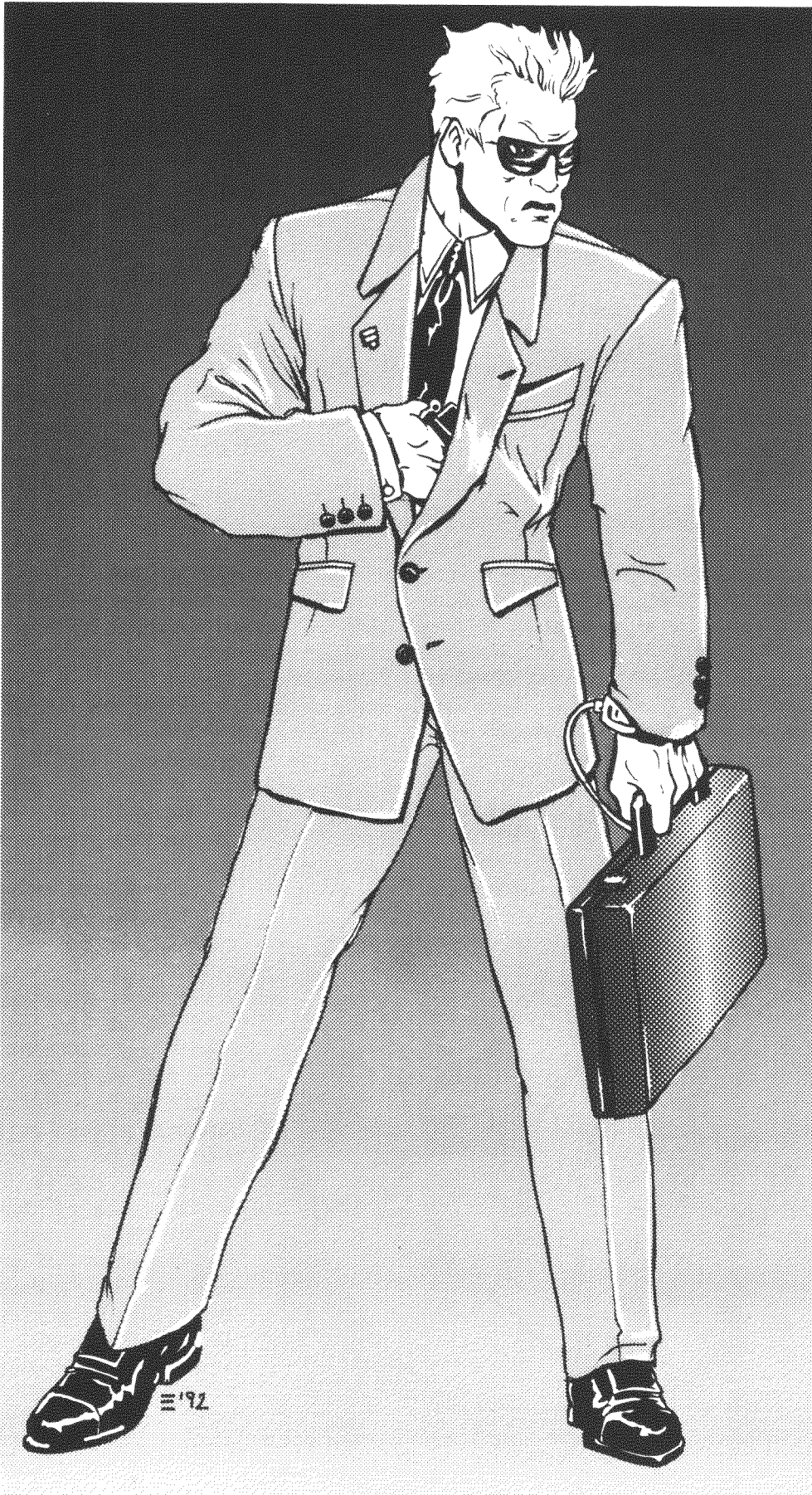

**"Money. Yeah, I got money: a new BMW aerodyne, and a penthouse flat in the Corporate Zone. All the money ain't worth frack. You play this game for power. The power to get things done; to make the big decisions; to affect things. You make a phone call, and the next thing you know, you're telling the president of some bushleague Euronation that he'd better play it your way, or he's history.**

**"That's why you play. That's why I'm with the Company."**

—An Unidentified Corporate

CYBERPUNKS

# FIXERS

**DEAL MAKERS, SMUGGLERS, ORGANIZERS  
AND INFORMATION BROKERS**

You realized fast that you weren't ever going to get into a Corporate job. And you didn't think you were tough enough or crazy enough to be a Solo either. But as a small time punk, you knew you had a knack for figuring out what other people wanted, and how to get it for them. For a price, of course.

Now your deals have moved past the nickle-and-dime stuff into the big time. Maybe you move illegal weapons over the border. Or steal and resell medical supplies from the Corporations. Perhaps you're a skill broker—

acting as an agent for high priced Solos and 'Runners, or even hiring a whole Nomad pack to back a client's contracts. You buy and sell favors like an old-style Mafia godfather. You have connections into all kinds of businesses, deals and political groups. You don't do this directly, of course—no, you use your contacts and allies as part of a vast web of intrigue and coercion. If there's a hot nightclub in the City, you've bought into it. If there are new military-class weapons on the Street, you smuggled 'em in. If there's a Corporate war going down, you're negotiating between sides with an eye on the main chance.



But you're not entirely in it for the bucks. If someone needs to get the heat off, you'll hide them. You get people housing when there isn't any, and you bring in food when the neighborhoods are blockaded. Maybe you do it because you know they'll owe you later, but you're not sure. You're one part Robin Hood and two parts Al Capone. Back in the 90's, they would have called you a *crimelord*. But this is the fragmented, nasty, deadly 2020s. Now they call you a Fixer.





**"Don't give me this "Robin Hood" stuff. I'm doin' a job, no more. I give people what they want, an' they pay me out.**

**"Okay, so maybe I even a few scores here and there, but that's good for business. You make a friend—they'll take you in when the Street's too hot, and they'll pass you a few blts of data when you call in the markers. But that's business.**

**"I got a slogan...  
"How much you pay me?"**

**—Phil "Nacho"  
Hernandez  
Fixer**

WIKS

# NOMADS

**ROAD WARRIORS AND GYPSIES WHO ROAM THE HIGHWAYS**

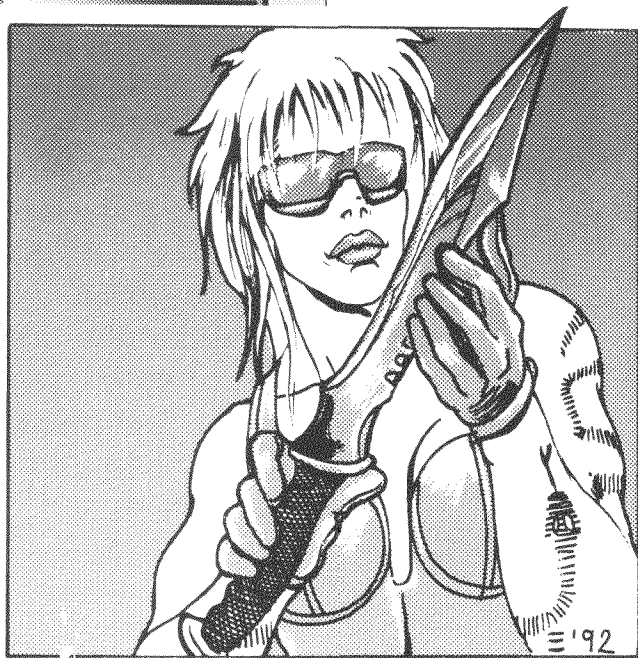

They drove your family off the Farm ten years ago. The Corporations rolled in, took over the land, and put rent-a-cops all over the place. It wasn't the first time it'd happened; it wouldn't be

and mechanics—it's virtually a town on wheels in which everyone is related by marriage or kinship. Sometimes the Pack pulls into a town just to fuel up or get grub. Other times, it swings south to follow the harvest; you pick crops in trade for cash or food. Less law abiding Packs are like mobile armies, terrorizing cities and hiring out as muscle in Corporate wars. For obvious reasons, the cops don't like Nomads. But it doesn't matter—your vehicles are usually well armored and bristling with stolen weapons; mini guns, rocket launchers and the like. Every kid knows how to use a rifle, and everyone packs a knife. Being homeless in the 2000's isn't easy.

the last. Gradually, your family fell in with a bunch of other homeless families, and they met another group...until you'd created a Nomad pack of nearly two hundred members.

Now, crammed into a huge, ragtag fleet of cars, vans, buses and RV's, your Nomad pack roams the freeways. You look for supplies, odd jobs and spare parts in a world where society has fragmented. The pack is your home—it has teachers, Med Techs, leaders,

The most visible members of the Pack are the Scouts—leather armored riders on bikes or in fast muscle cars, who protect the convoy from attacks and hunt up safe campsites. As a Scout, you're on the lookout for trouble, and you usually can find enough of it, with rival Nomad Packs, the Law, and the Corporates all after you. Like a modern day cowboy, you ride the hard trail. You've got a gun, a bike and that's all you need. You're a Nomad.

GRB



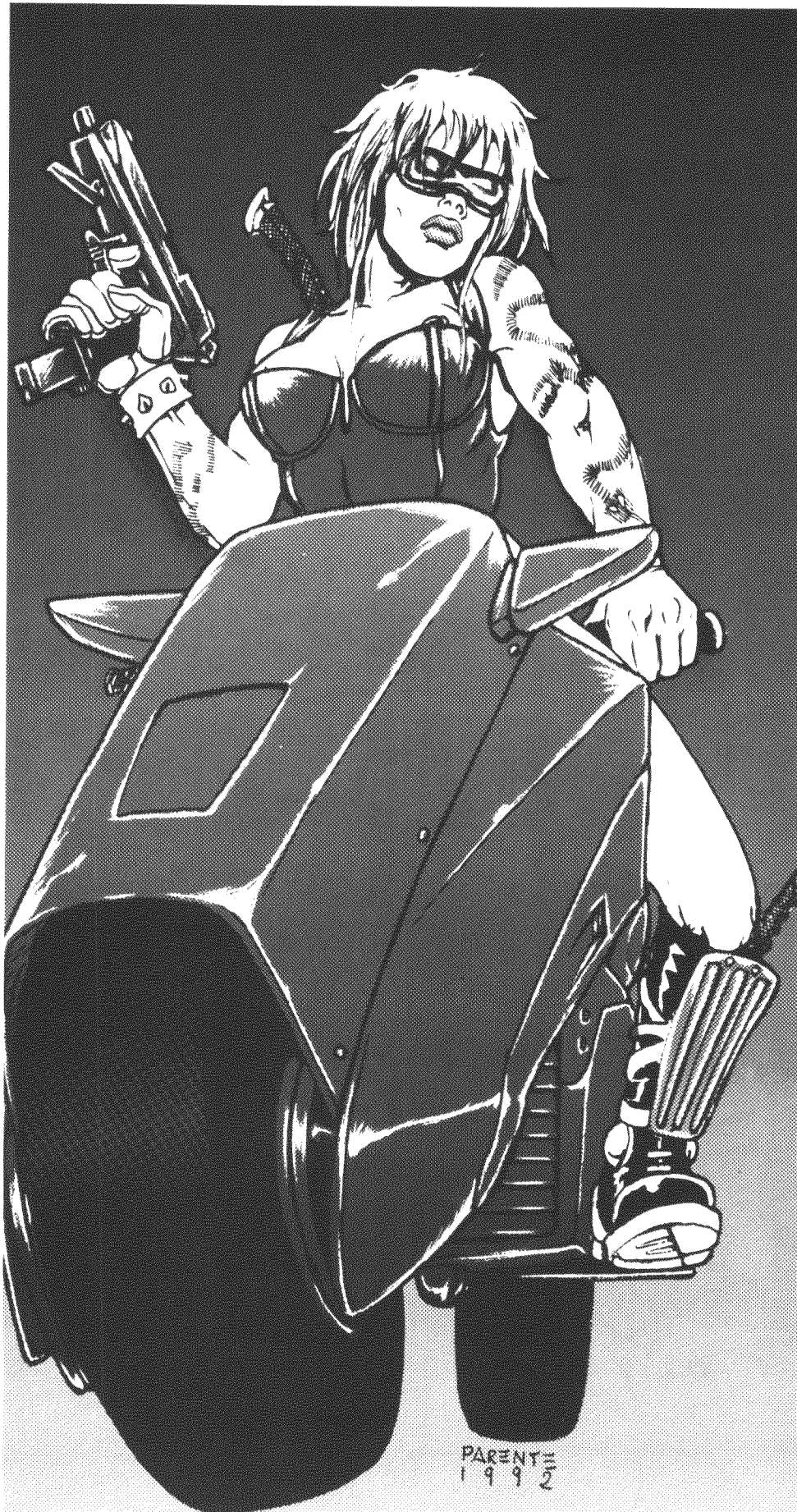

**"Guns. Guns and cyberbikes. That's how we hold the line. We don't have any home except the Caravan. We don't have any rights except what we take. We get run out of town by the cops; we get raided by the roadwarrior packs, and we survive because we've got guns and bikes..."**

**"There's kids, old men and women—families here. This ain't no boostergang. These people are my family."**

**—Nomad Santiago**



**ROLES**  
**CHARACTERS**  
**LIFEPATH**  
**TASK & SKILLS**  
**WEAPONS**  
**ARMOR**  
**GEAR**  
**CYBERWEAR**  
**COMBAT**  
**MEDICAL**  
**NETRUNNING**



**"They were roaring in at top speed when they hit us. There must have been a hundred of them. We were pinned down and about to be turned into Ground Food Concentrate Number Fifteen. Then Razorjack popped the BigRipps, screamed like a banshee on steroids, and went right over the top of the lead cyberbike."**

**—Savage Doc**

**Dice**

All systems in Cyberpunk use two types of dice; the common, garden variety six sided die (found in most popular games and in Las Vegas), and the more esoteric ten sided die (used exclusively by the Japanese Imperial Navy and in many roleplaying games). Dice are usually referred to in Cyberpunk as a "D", followed by the number of sides of the dice. For example, a normal 6 sided die would be referred to as a "D6". There are a number of ways in which dice can be used, such as:

- Rolling a group of dice together and adding the results (roll 3D6 would mean roll 3 six sided dice to get a value from 3 to 18).
- Rolling one or more dice together and adding another value called a modifier to get a final value, expressed as 1D6+1, or 1D10 -2.
- Rolling two ten sided dice together, designating one to mark the tens place and the other to mark the ones place (called rolling a percentage).

**Rounding and Modifying:** In Cyberpunk, if you are asked to divide something and you come up with a decimal value, you will automatically round the result down to the nearest whole number (such as 2.65352 becoming 2). If a modified value (such as 1D6-4) comes out equal to, or below zero, it is automatically equal to 1 unless otherwise specified.

**SECTION**  
**2**

# GETTING CYBERPUNK

**Headware is the hardware—the frame which allows the character to interface with the rules. Remember, the disk is not the software, and dice rolls are not your character. Don't get too caught up in the statistics.**

**Character Points**

Character points are the cash of character creation—you use them to "buy" the various "mechanics" aspects of the character, like good looks, a strong, hard body, unshakable cool and street smarts (but not Skills). We've given you three ways to generate Character Points:

**Headware: The stuff you need to make a Cyberpunk persona interface with the Rules of the Game.**

2) Fast: Roll 1D10 for each stat (9 in all), re-rolling any scores of 2 or less. Place rolls in each stat as desired.

3) Cinematic: This option is for Referees only. As the designer of the adventure, the Referee has the option of choosing the number of points for each character based on its position in his or her game.

Major Hero .....	80pts
Major Supporting Char. ....	70pts
Minor Hero .....	75pts
Minor Supporting Char. ....	60pts
Average .....	50pts

**Note:** We could, at this point, warn prospective Referees about the various dodges their players will have for creating "supercharacters." But face it; if they want to create a mondo character, who are we to stop them? You're all big boys and girls now, and if you, as Referee, think your players are getting way outa line, why not just

go ahead and waste 'em?

That's the Cyberpunk way.

1) **Random:** Roll 9 D10 and total them. You have this many Character Points.

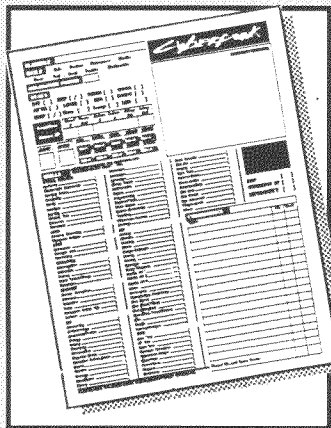
THE HARDCOPY  
FORM

*First thing you're going to need is a place to record all of your information. Photocopy (or draw) your own Hardcopy Form to work on. Make sure you keep a backup of this form, just in case the original gets fragged in the middle of a run.*

**REMEMBER: THE  
FUTURE IS  
DISPOSABLE.**

*Okay, get out your Hardcopy, roll your dice, and let's start plugging in your character.*

## Statistics

Each *Cyberpunk* character has nine Statistics—values representing the level of native ability of the character in specific areas of activity. These Stats are rated from two to ten, with two being the worst possible, ten being the best possible, and the average falling at about five or six. Divide your total number of Character Points between each of your nine Stats, adjusting the amounts in each one as you think best describes the character's natural abilities. No Statistic may be less than two or greater than ten.

### Intelligence (INT):

This is a measure of your problem solving ability; figuring out problems, noticing things, remembering information. Almost every character type will need a high Intelligence, with Netrunners and Corporates requiring the highest of all.

### Reflexes (REF):

This is a combined index, covering not only your basic dexterity, but also how your level of physical coordination will affect feats of driving, piloting, fighting and athletics. Characters who intend to engage in a great deal of combat (such as Solos, Nomads or Rockerboys) should always invest in the highest possible Reflex.

### Cool (CL):

This index measures how well the character stands up to stress, fear, pressure, physical pain and/or torture. In determining your willingness to fight on despite wounds or your fighting ability under fire, *Cool*(CL) is essential. It is also the measure of how "together" your character is and how tough he appears to others. Rockerboys and Fixers should always have a high Cool, with Solos and Nomads having the highest of all.

### Technical Ability (TECH):

This is an index of how well you relate to hardware and other technically oriented things. In *Cyberpunk*, the ability to use and repair technology is of paramount importance—TECH will be the Stat used when fixing, repairing and attempting to use unfamiliar tech. While all characters should

have a decent Tech Stat, potential Techies should always opt for the highest possible score in this area.

### Luck (LK):

This is the intangible "something" that throws the balance of events into your favor. Your luck represents how many points you may use each game to influence the outcome of a critical event. To use Luck, you may add any or all of the points of luck a character has to a critical die roll (declaring your intention to use Luck before the roll is made) until all of your Luck stat is used up. Luck is always restored at the end of each game session.

### Attractiveness (ATT):

This is how good-looking you are. In *Cyberpunk*, it's not enough to be good—you have to look good while you're doing it (Attitude is Everything). Attractiveness is especially important to Medias and Rockerboys, as being good-looking is part of their jobs.

### Movement Allowance (MA):

This is an index of how fast your character can run (important in combat situations). The higher your Movement Allowance (MA), the more distance you can cover in a turn.

**RUN:** To determine how far your character can run in a single combat round (@3.2 seconds) in meters, multiply your MA by 3. The character can run three times this distance in a full 10 second turn. Write this in the RUN section of your Hardcopy Form.

**LEAP:** To determine how far your character can leap (from a running start), divide your RUN by 4. Write this in the LEAP section of your Hardcopy Form.

### Empathy:

This Stat represents how well you relate to other living things—a measure of charisma and sympathetic emotions. In a world of alienated, future-shocked survivors, the ability to be "human" can no longer be taken for granted. Empathy (EM) is critical







when leading, convincing, seducing or perceiving emotional undercurrents. Empathy is also a measure of how close he/she is to the line between feeling human being and cold blooded cyber-monster (see pg. 73 for details).

**Humanity :** This is a measure of the toll cybernetics takes on your ability to relate to other living things. Multiply your EMP by 10 to determine how many humanity points you have. Write the result in the box on your Hardcopy Form. Remember: for every 10 points of Humanity lost, you will automatically lose 1 point of EMP. This can have a serious effect on any Empathy-related Skills, as well as forcing you to the edge of cybernetic-induced psychosis.

**"Dead is Dead. Parts is Parts. Dead guys is Parts."  
—Ripperjack**

knockout drugs, you will be required to make a **Stun Save**. If you fail a Stun Save, you will automatically be knocked out of combat and be unable to recover until you can make a *successful* Stun Save in a following combat turn. You may make one Save roll every turn until you succeed.

**Death Saves:** When you have been Mortally Wounded (see *Friday Night Firefight*, pg. 104), or when you have encountered certain types of poisons, you

will need to make a Save against **Death**. On a failed roll, you're Body Bank fodder.

Take a moment to find the Save box on your Hardcopy Form and fill it in.

**Body Type (BT)**

Strength, Endurance and Constitution are all based on the character's Body Type. Body Type determines how much damage you can take in wounds, how much you can lift or carry, how far you can throw (pg. 99), how well you recover from shock, and how much additional damage you cause with physical attacks. Body Type is important to all character types, but to Solos, Rockerboys and Nomads most of all.

**Body Type Modifier (BTM)**

Not all people take damage the same way. For example, it takes a lot more damage to stop Arnold The Terminator than it does Arnold the Nerd. This is reflected by the **Body Type Modifier**, a special bonus used by your character to reduce the effects of damage. The Body type modifier is subtracted from any damage your character takes in combat.

**BODY TYPES & POINTS**

- 2 pts ..... Very Weak
- 3-4 pts ..... Weak
- 5-7 pts ..... Average
- 8-9 pts ..... Strong
- 10 pts ..... Very Strong

**BODY TYPE MODIFIER TABLE**

Very Weak .....	-0
Weak .....	-1
Average .....	-2
Strong .....	-3
Very Strong .....	-4
Superhuman* .....	-5

\*Possible only w th cybernetics

You may carry up to 10x your Body Type in kg. You may also dead lift 40 times your Body Type in kg.

**Save Number**

Your character's **Save Number** is a value equal to your Body Type. To make saves, you must roll a value on 1D10 equal to or lower than this number. There are two types of saves in *Cyberpunk*:

**Stun Saves:** When you take damage in *Cyberpunk*, or have been exposed to

*For example, say you took ten points of damage. If you were a Very Weak Body Type, you would take the full ten. But with a Very Strong Body Type, you'd only take (10-4=6) six points of damage.*

Find the Body Type Modifier (BTM) box on your Hardcopy Form and fill it in. Remember; no matter how cybered up you get, make sure you're solid meat underneath.

**"Attention, Bodybankers! We've got a Blue Light Special going on right now in Cryochamber Number Fifteen! We've got eyes in all colors and conditions, going for half price! Hurry on down to Chamber Fifteen for best selection, and get 'em before they spoil..."**

**—Medicross Preservation**



### MASTER SKILL LIST

#### SPECIAL ABILITIES

Authority (Cop)  
 Combat Sense (Solo)  
 Charis. Leadership (Rocker)  
 Credibility (Media)  
 Family (Nomad)  
 Interface (Netrunner)  
 Jury Rg (Techie)  
 Medical Tech (Medtechie)  
 Resources (Corp)  
 Streetdeal (Fixer)

#### ATTR

Personal Grooming  
 Wardrobe & Style

#### BODY

Endurance  
 Strength Feat  
 Swimming

#### COOL/WILL

Interrogation  
 Intimidate  
 Oratory  
 Resist Torture/Drugs  
 Streetwise

#### EMPATHY

Human Perception  
 Interview  
 Leadership  
 Seduction  
 Social  
 Persuasion & Fast Talk  
 Perform

#### INT

Accounting  
 Anthropology  
 Awareness/Notice  
 Biology  
 Botany  
 Chemistry  
 Composition  
 Diagnose Illness  
 Education & Gen. Know  
 Expert  
 Gamble  
 Geology  
 Hide/Evade  
 History  
 Know Language (choose)  
 Library Search  
 Mathematics  
 Physics  
 Programming  
 Shadow/Track  
 Stock Market  
 System Knowledge  
 Teaching  
 Wilderness Survival  
 Zoology

#### REF

Archery  
 Athletics  
 Brawling  
 Dance  
 Dodge & Escape  
 Driving  
 Fencing  
 Handgun  
 Heavy Weapons  
 Martial Art (choose type)  
 Melee  
 Motorcycle  
 Operate Hvy. Machinery  
 Pilot (Gyro)  
 Pilot (Fixed Wing)  
 Pilot (Dirigible)  
 Pilot (Vect. Thrust Vehicle)  
 Rifle  
 Stealth  
 Submachinegun

#### TECH

Aero Tech  
 AV Tech  
 Basic Tech  
 Cryotank Operation  
 Cyberdeck Design  
 CyberTech  
 Demolitions  
 Disguise  
 Electronics  
 Elect. Security  
 First Aid  
 Forgery  
 Gyro Tech  
 Paint or Draw  
 Photo & Film  
 Pharmaceuticals  
 Pick Lock  
 Pick Pocket  
 Play Instrument  
 Weaponsmith

## Fast and Dirty Expendables

As you'll soon realize, the *Cyberpunk* character generation system is designed to give you a lot of flexibility. You can tailor the character the way you want it, with lots of personal touches all through the process.

But when you need to generate a horde of faceless boostergangers, you're not going to want to invest this kind of time and energy. Instead, you'll need something fast and easy to help you create endless supplies of baddies to be mowed down like chaff by your player characters.

The five step **FAST CHARACTER SYSTEM** below allows you to generate a large supply of faceless guards, killers, corps and bad guys on demand. A quick run through Lifepath can create a fast and dirty background to match your fast and dirty NPCs. So go ahead and waste 'em! *We'll make more!*

### Step One: Generate Stats

1) Roll 2D6 nine times, writing down each roll. If a roll is 11 or greater, reroll that value. Place each number in one Stat until all Stats are filled.

### Step 2: Pick a Role & Skills

1) Select a role for the character. Write its Career Skill Package (pg.44) in the appropriate space, dividing 40 points between these skills.

2) If the character is an advanced NPC, roll an additional 2D10 and distribute these points among 5 pickup skills.

### Step 3: Pick Cyberware (see pgs. 76-79)

Roll 1D10. Solos roll 6 times. All others roll 3 times. If duplicate rolls, re-roll.

- Cyberoptics (Roll 1D6 for type)
  - Infrared
  - Lowlight
  - Camera
  - Dartgun
  - Antidazzle
  - Targeting scope
- Cyberarm with gun (Roll 1D6 for type)
  - Med. Pistol
  - Light Pistol

- Med. Pistol
- Light Submachinegun
- Very Heavy Pistol
- Heavy Pistol

### 3) Cyberaudio (Roll 1D6 for type)

- Wearman™
- Radio Splice
- Phone link
- Amplified Hearing
- Sound Editing
- Digital Recording Link

- Big Knucks
- Rippers
- Vampires
- Slice n'dice
- Reflex Boost (Kerenzikov)
- Reflex Boost (Sandevistan)
- Nothing

### Step 4: Armor & Weapons

Roll 1D10, adding modifier below:

Roll	Armor	Weapon
1	Heavy Leather	Knife
2	Armor Vest	Light Pistol
3	Light Armor Jacket	Medium Pistol
4	Light Armor Jacket	Heavy Pistol
5	Med Armor Jacket	Heavy Pistol
6	Med. Armor Jacket	Light SMG
7	Med. Armor Jacket	Lt. Assault Rifle
8	Hvy. Armor Jacket	Med. Assault Rifle
9	Hvy. Armor Jacket	Hvy. Assault Rifle
+10	MetalGear™	Hvy. Assault Rifle

- Rockers, Corps, Netrunners, Fixers, Techies: add 0 to roll.
- Nomads, Cops: add +2 to roll.
- Solos: add +3 to roll.

### Step 5: Write it down.

Fill out an NPC (Non-player Character) sheet, as shown below:

<b>NAME</b>		<b>ROLE</b>																					
<b>STATS</b>																							
INT [ ]	REF [ / ]	TECH [ ]	COOL [ ]																				
ATTR [ ]	LUCK [ ]	MA [ ]	BODY [ ]																				
EMP [ / ]	Run [ ]	Leap [ ]	Lift [ ]																				
<b>Location</b>	Head 1	Torso 2-4	R.Arm 5																				
	L.Arm 6	R.Leg 7-8	L.Leg 9-0																				
<b>Armor SP</b>																							
<b>SAVE</b>	<b>BTM</b>	<table border="1"> <tr> <td>LIGHT</td> <td>SERIOUS</td> <td>CRITICAL</td> <td>MORTAL0</td> <td>MORTAL1</td> </tr> <tr> <td>Stun=0</td> <td>Stun=1</td> <td>Stun=2</td> <td>Stun=3</td> <td>Stun=4</td> </tr> <tr> <td>MORTAL2</td> <td>MORTAL3</td> <td>MORTAL4</td> <td>MORTAL5</td> <td>MORTAL6</td> </tr> <tr> <td>Stun=5</td> <td>Stun=6</td> <td>Stun=7</td> <td>Stun=8</td> <td>Stun=9</td> </tr> </table>		LIGHT	SERIOUS	CRITICAL	MORTAL0	MORTAL1	Stun=0	Stun=1	Stun=2	Stun=3	Stun=4	MORTAL2	MORTAL3	MORTAL4	MORTAL5	MORTAL6	Stun=5	Stun=6	Stun=7	Stun=8	Stun=9
LIGHT	SERIOUS	CRITICAL	MORTAL0	MORTAL1																			
Stun=0	Stun=1	Stun=2	Stun=3	Stun=4																			
MORTAL2	MORTAL3	MORTAL4	MORTAL5	MORTAL6																			
Stun=5	Stun=6	Stun=7	Stun=8	Stun=9																			
<b>Cybernetics</b>																							
_____																							
<b>Special Ability</b>																							
_____																							
<b>Skills</b>																							
_____																							
<b>Possessions</b>																							
_____																							

© R. Takayan Games, 1990. Permission granted for personal photocopying only.

<b>NAME</b>		<b>ROLE</b>	
-------------	--	-------------	--

**STATS**

INT [ ] REF [ / ] TECH [ ] COOL [ ]  
 ATTR [ ] LUCK [ ] MA [ ] BODY [ ]  
 EMP [ / ] Run [ ] Leap [ ] Lift [ ]

<b>Location</b>	<b>Head</b> 1	<b>Torso</b> 2-4	<b>R.Arm</b> 5	<b>L.Arm</b> 6	<b>R.Leg</b> 7-8	<b>L.Leg</b> 9-0
<b>Armor SP</b>						

<b>SAVE</b>	<b>BTM</b>	<b>LIGHT</b>	<b>SERIOUS</b>	<b>CRITICAL</b>	<b>MORTALO</b>	<b>MORTAL1</b>
		Stun=0	Stun=-1	Stun=-2	Stun=-3	Stun=-4
		<b>MORTAL 2</b>	<b>MORTAL3</b>	<b>MORTAL4</b>	<b>MORTAL 5</b>	<b>MORTAL 6</b>
		Stun=-5	Stun=-6	Stun=-7	Stun=-8	Stun=-9

**Cybernetics**

---



---

**Special Ability**

---

**Skills**

---



---

**Possessions**

---



---

© R.Talsorian Games, 1991. Permission granted for personal photocopying only.

<b>NAME</b>		<b>ROLE</b>	
-------------	--	-------------	--

**STATS**

INT [ ] REF [ / ] TECH [ ] COOL [ ]  
 ATTR [ ] LUCK [ ] MA [ ] BODY [ ]  
 EMP [ / ] Run [ ] Leap [ ] Lift [ ]

<b>Location</b>	<b>Head</b> 1	<b>Torso</b> 2-4	<b>R.Arm</b> 5	<b>L.Arm</b> 6	<b>R.Leg</b> 7-8	<b>L.Leg</b> 9-0
<b>Armor SP</b>						

<b>SAVE</b>	<b>BTM</b>	<b>LIGHT</b>	<b>SERIOUS</b>	<b>CRITICAL</b>	<b>MORTALO</b>	<b>MORTAL1</b>
		Stun=0	Stun=-1	Stun=-2	Stun=-3	Stun=-4
		<b>MORTAL 2</b>	<b>MORTAL3</b>	<b>MORTAL4</b>	<b>MORTAL 5</b>	<b>MORTAL 6</b>
		Stun=-5	Stun=-6	Stun=-7	Stun=-8	Stun=-9

**Cybernetics**

---



---

**Special Ability**

---

**Skills**

---



---

**Possessions**

---



---

© R.Talsorian Games, 1991. Permission granted for personal photocopying only.

<b>NAME</b>		<b>ROLE</b>	
-------------	--	-------------	--

**STATS**

INT [ ] REF [ / ] TECH [ ] COOL [ ]  
 ATTR [ ] LUCK [ ] MA [ ] BODY [ ]  
 EMP [ / ] Run [ ] Leap [ ] Lift [ ]

<b>Location</b>	<b>Head</b> 1	<b>Torso</b> 2-4	<b>R.Arm</b> 5	<b>L.Arm</b> 6	<b>R.Leg</b> 7-8	<b>L.Leg</b> 9-0
<b>Armor SP</b>						

<b>SAVE</b>	<b>BTM</b>	<b>LIGHT</b>	<b>SERIOUS</b>	<b>CRITICAL</b>	<b>MORTALO</b>	<b>MORTAL1</b>
		Stun=0	Stun=-1	Stun=-2	Stun=-3	Stun=-4
		<b>MORTAL 2</b>	<b>MORTAL3</b>	<b>MORTAL4</b>	<b>MORTAL 5</b>	<b>MORTAL 6</b>
		Stun=-5	Stun=-6	Stun=-7	Stun=-8	Stun=-9

**Cybernetics**

---



---

**Special Ability**

---

**Skills**

---



---

**Possessions**

---



---

© R.Talsorian Games, 1991. Permission granted for personal photocopying only.

<b>NAME</b>		<b>ROLE</b>	
-------------	--	-------------	--

**STATS**

INT [ ] REF [ / ] TECH [ ] COOL [ ]  
 ATTR [ ] LUCK [ ] MA [ ] BODY [ ]  
 EMP [ / ] Run [ ] Leap [ ] Lift [ ]

<b>Location</b>	<b>Head</b> 1	<b>Torso</b> 2-4	<b>R.Arm</b> 5	<b>L.Arm</b> 6	<b>R.Leg</b> 7-8	<b>L.Leg</b> 9-0
<b>Armor SP</b>						

<b>SAVE</b>	<b>BTM</b>	<b>LIGHT</b>	<b>SERIOUS</b>	<b>CRITICAL</b>	<b>MORTALO</b>	<b>MORTAL1</b>
		Stun=0	Stun=-1	Stun=-2	Stun=-3	Stun=-4
		<b>MORTAL 2</b>	<b>MORTAL3</b>	<b>MORTAL4</b>	<b>MORTAL 5</b>	<b>MORTAL 6</b>
		Stun=-5	Stun=-6	Stun=-7	Stun=-8	Stun=-9

**Cybernetics**

---



---

**Special Ability**

---

**Skills**

---



---

**Possessions**

---



---

© R.Talsorian Games, 1991. Permission granted for personal photocopying only.

**ROLES**  
**CHARACTERS**  
**LIFEPATH**  
**TASK & SKILLS**  
**WEAPONS**  
**ARMOR**  
**GEAR**  
**CYBERWEAR**  
**COMBAT**  
**MEDICAL**  
**NETRUNNING**





*"I remember she told me she was born in Miami, about 2004 or so...She was pretty sure, because she could still remember what it'd been like when the Euros rocked Washington and the near miss took out Tampa..."*

*"She had these incredible blue eyes; clear through and through, like crystals of Lace, and a smile from a magazine dream. 'Course, the eyes were Teknics 2350's, and the smile really was from a magazine—nice biosculpt job. It didn't matter how much was real in the end. I still fell hard for her. I'm that type."*

—Johnny Silverhand

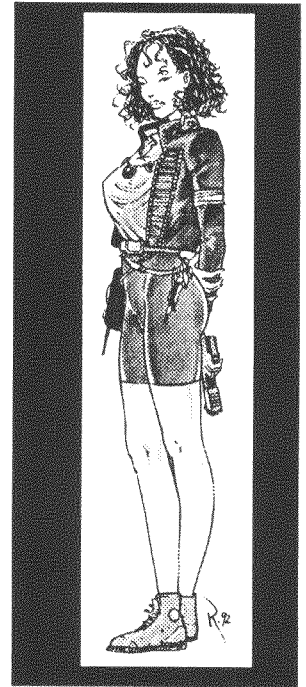

**EVERYONE ON THE STREET HAS A STORY. WHAT'S YOURS?**

The way to find out is by using this Lifepath.

From its pages, you'll discover your past; enemies, friends, lovers and liars. The Lifepath will give you the clues you need to make this person work for you. It'll also give your Referee some idea of how to put an adventure around a bunch of numbers.

## SECTION 3 TALES FROM THE STREET

*It's like climbing out of the clone vat.*

You got this half-formed person standing there, dripping with slime. You got some stats, maybe an vague idea of where you're going with the character, but nothing else.

So how do you take this Blank and make him really *Cyberpunk*?

You start with the Lifepath. Lifepath is a flowchart of "plot complications", designed to help you give your *Cyberpunk* character an authentically dark future background.

Its seven sections cover your national and ethnic origins, your family, friends, enemies, personal habits and even key events on a yearly basis. It's intended primarily as a guide; if you encounter something you don't think fits the character you've envisioned, feel free to change the path as you see fit. Use the back of your **Hardcopy** sheet to record your Lifepath. Remember; *Cyberpunk* hinges on roleplaying, so make use of the information in your Lifepath run. It's a guaranteed adventure generator!

### STREETSLANG

#### SOME COMMON TERMS OF THE 21ST CENTURY

**AI:** Artificial Intelligence; a computer with full self awareness.

**Booster:** any member of a gang that affects cyberwear, leather clothing and random violence.

**Combat drugs:** any one of a series of designer drugs created to increase speed, stamina and reflexes.

**Chilled:** to be cool; to be together.

**Chippin' In:** To buy cyberwear for the first time. To cast your lot with a group. To connect with a machine.

**Chombatta (Choomba):** Neo-Afro American slang for friend, family member.

**CHOOH<sup>2</sup> ("choo")** Streetslang for alcohol, as used in vehicle power plants. The vast majority of vehicles in the 2000's are fueled by an advanced form of alcohol with a higher burning temperature than normal methanol.

**Chromer:** 21st century heavy metal rock fan. See also *Chromatic rocker*, *Chromatic rock*.

**Chromatic rock:** a type of heavy metal characterized by heavy electronics, simple rhythms and violent lyrics.

**Cybered Up:** to get as much cyberwear implanted as possible before you go over the Edge.

**Data Term:** a streetcorner information machine, with a screen, Net inputs, and keyboard.

**Disk:** record, recording; a laser disk.

**'Dorphs:** Streetslang for synthetic endorphins, a designer drug that increases healing powers, limits fatigue, and produces a "rush" similar to a second wind.

**Exotic:** a human biosculpted with non-human elements; fur, long ears, fangs, etc.

**The Face:** The Interface. Jacking into the Net.

**Flatline:** to kill. A dead person or thing.

**Go LEO:** to make the trip into Low Earth Orbit; i.e., to visit one of the inner space stations.

**Gyro:** small one or two man helicopters, used mostly in police work and Corporate strike operations.

**Handle:** a nickname; a working name you are known by on the Street.

**Hydro:** Streetslang for hydrogen fuel, used to power a sizable number of vehicles in the 2000's.

**Input:** girlfriend.

**Keyboard:** Streetslang for a computer interface deck with manual keys. Also a terminal.

**Netrun:** to interface with the Net and use it to hack into Data Fortresses.

## START HERE

### 1) Origins and Personal Style

**What do you look like and where do you come from?**

#### DRESS & PERSONAL STYLE

In *Cyberpunk*, what you look like is what you are. Fashion is action, and style is everything. Roll 1D10 three times (once per column) to decide what *your* style is.

Die Roll	Clothes	Hairstyle	Affectations
1	Biker leathers	Mohawk	Tatoos
2	Blue jeans	Long & Ratty	Mirrorshades
3	Corporate Suits	Short & Spiked	Ritual Scars
4	Jumpsuits	Wild & all over	Spiked gloves
5	Miniskirts	Bald	Nose Rings
6	High Fashion	Striped	Earrings
7	Cammos	Tinted	Long fingernails
8	Normal clothes	Neat, short	Spike heeled boots
9	Nude	Short, curly	Weird Contact Lenses
10	Bag Lady chic	Long, straight	Fingerless gloves

#### ETHNIC ORIGINS

**The Cyberpunk world is multi-cultural and multinational. Where you come from determines your native language, customs and allegiances. Choose or roll one nationality, then choose a native tongue from the options listed for the ethnic type. This is your native language, which you speak at +8. In addition, you also automatically know *streetslang*, a universal polyglot of English, French, German, Japanese and a half dozen other languages:**

- 1 Anglo-American (English)
- 2 African (Bantu, Fante, Kongo, Ashanti, Zulu, Swahili)
- 3 Japanese/Korean (Japanese or Korean)
- 4 Central European/Soviet (Bulgarian, Russian, Czech, Polish, Ukranian, Slovak)
- 5 Pacific Islander (Microneasian, Tagalog, Polynesian, Malayan, Sudanese, Indonesian, Hawaiian)
- 6 Chinese/Southeast Asian (Burmese, Cantonese, Mandarin, Thai, Tibetan, Vietnamese)
- 7 Black American (English, Blackfolk)
- 8 Hispanic American (Spanish, English)
- 9 Central /South American (Spanish, Portuguese)
- 10 European (French, German, English, Spanish, Italian, Greek, Danish, Dutch, Norwegian, Swedish, Finnish)

**Output:** boyfriend.

**Polymer one shot:** any cheap plastic pistol, usually in the 5 to 6mm range.

**Posergang:** any group whose members all affect a specific look, style or bodysculpt job.

**Ripperdoc:** surgeon specializing in implanting illegal cyberwear.

**Ronin:** a freelance assassin or mercenary. Usually considered to be untrustworthy.

**Rockerboy/girl:** a musician or performer who uses his or her art to make political or social state-

ments. Rockerboys are not the same as rockstars, who are usually "owned" by recording mediacorps and are apolitical.

**Samurai:** a corporate assassin or mercenary, hired to protect Corporation property or make strikes against other Corporate holdings.

**Slammit On:** to get violent; to attack someone without reason.

**The Street:** wherever you live, late at night. The Subculture; the Underground.

**Stuffit:** to have sex. Also; to forget about something.

## 2) Family Background

Who are you, and where did you come from? Everybody on the Street has a story and a past they're trying to live with. What's yours?

### FAMILY RANKING

(choose or roll one:

- 1 Corporate Executive
- 2 Corporate Manager
- 3 Corporate Technician
- 4 Nomad Pack
- 5 Pirate Fleet
- 6 Gang Family
- 7 Crime Lord
- 8 Combat Zone Poor
- 9 Urban homeless
- 10 Arcology family

Go to **PARENTS**

### PARENTS

Choose or roll one:

- 1-6 Both parents are living. Go to **FAMILY STATUS**
- 7-10 Something has happened to one or both parents. Go to **SOMETHING HAPPENED TO YOUR PARENTS**.

### SOMETHING HAPPENED TO YOUR PARENTS

Choose or roll one:

- 1 Your parent(s) died in warfare
- 2 Your parent(s) died in an accident
- 3 Your parent(s) were murdered
- 4 Your parent(s) have amnesia and don't remember you
- 5 You never knew your parent(s)
- 6 Your parent(s) are in hiding to protect you
- 7 You were left with relatives for safekeeping
- 8 You grew up on the Street and never had parents
- 9 Your parent(s) gave you up for adoption
- 10 Your parent(s) sold you for money

Go to **FAMILY STATUS**

### FAMILY STATUS

Choose or roll one:

- 1-6 Family status in danger, and you risk losing everything (if you haven't already) Go to **FAMILY TRAGEDY**
- 7-10 Family status is OK, even if parents are missing or dead. Go to **CHILDHOOD ENVIRONMENT**

### CHILDHOOD ENVIRONMENT

Your Childhood was (choose or roll one):

- 1 Spent on the Street, with no adult supervision
- 2 Spent in a safe Corporate Suburbia
- 3 In a Nomad Pack moving from town to town
- 4 In a decaying, once upscale neighborhood
- 5 In a defended Corporate Zone in the central City
- 6 In the heart of the Combat Zone
- 7 In a small village or town far from the City
- 8 In a large arcology city
- 9 In an aquatic Pirate Pack
- 10 On a Corporate controlled Farm or Research Facility

Go to **SIBLINGS**

### FAMILY TRAGEDY

Choose or roll one:

- 1 Family lost everything through betrayal
- 2 Family lost everything through bad management
- 3 Family exiled or otherwise driven from their original home/nation/corporation
- 4 Family is imprisoned and you alone escaped.
- 5 Family vanished. You are the only remaining member
- 6 Family was murdered /killed and you were the only survivor
- 7 Family is involved in a longterm conspiracy, organization or association, such as a crime family or revolutionary group
- 8 Your family was scattered to the winds due to misfortune
- 9 Your family is cursed with a hereditary feud that has lasted for generations
- 10 You are the inheritor of a family debt; you must honor this debt before moving on with your life

Go to **CHILDHOOD ENV.**

### SIBLINGS

You may have up to 7 brothers/sisters.

Roll 1D10. 1-7 is equal to the number of siblings you have. On 8-10, you are an only child. For each brother or sister:

1) Roll 1D10. Even: the sibling is male. Odd: the sibling is female.

2) Roll age, relative to yourself

1-5 =older

6-9=younger

10=twin

3) For each sibling, chose or roll their feelings about you:

1-2 Sibling dislikes you

3-4 Sibling likes you

5-6 Sibling neutral

7-8 They hero worship you

9-10 They hate you

Go to **MOTIVATIONS**



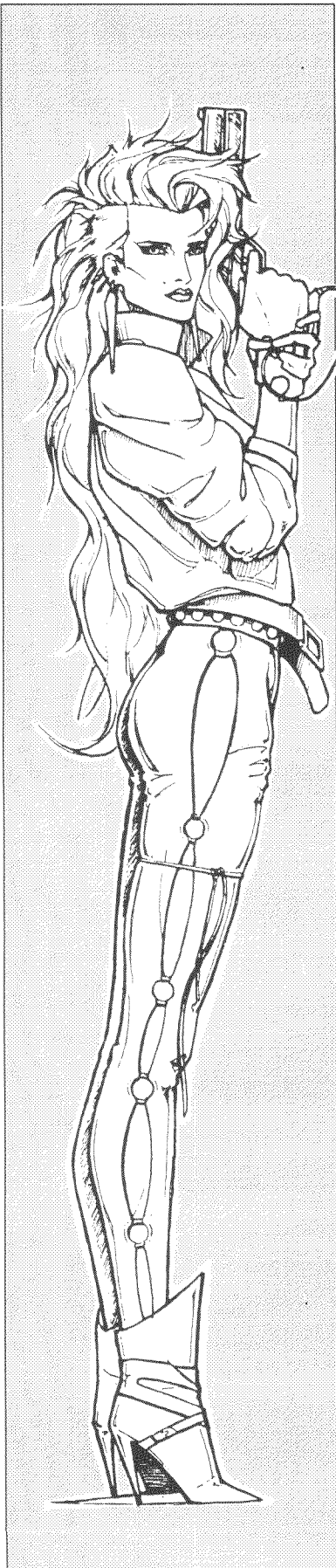

### 3) Motivations

What makes you tick? Will you back up your friends or go for the main chance? What's important to you?

#### PERSONALITY TRAITS

Choose or roll one:

- 1 Shy and secretive
- 2 Rebellious, antisocial, violent
- 3 Arrogant, proud and aloof
- 4 Moody, rash and headstrong
- 5 Picky, fussy and nervous
- 6 Stable and serious
- 7 Silly and fluffheaded
- 8 Sneaky and deceptive
- 9 Intellectual and detached
- 10 Friendly and outgoing

#### PERSON YOU VALUE MOST

Choose or roll one:

- 1 A parent
- 2 Brother or sister
- 3 Lover
- 4 Friend
- 5 Yourself
- 6 A pet
- 7 Teacher or mentor
- 8 Public figure
- 9 A personal hero
- 10 No one

#### WHAT DO YOU VALUE MOST?

Choose or roll one:

- 1 Money
- 2 Honor
- 3 Your word
- 4 Honesty
- 5 Knowledge
- 6 Vengeance
- 7 Love
- 8 Power
- 9 Having a good time
- 10 Friendship

#### YOUR MOST VALUED POSSESSION

Choose or roll one:

- 1 A weapon
- 2 A tool
- 3 A piece of clothing
- 4 A photograph
- 5 A book or diary
- 6 A recording
- 7 A musical instrument
- 8 A piece of jewelry
- 9 A toy
- 10 A letter

#### HOW DO YOU FEEL ABOUT MOST PEOPLE?

Choose or roll one:

- 1-2 Neutral
- 3 I like almost everyone
- 4 I hate almost everyone
- 5 People are tools. Use them for your own goals and discard them
- 6 Every person is a valuable individual
- 7 People are obstacles to be destroyed if they cross me
- 8 People are untrustworthy. Don't depend on anyone
- 9 Wipe 'em all out and give the place to the cockroaches
- 10 People are wonderful

### GO TO LIFE EVENTS

### 4) Life Events

You know where you came from and what you look like. Now let's take a look at the major events that made you what you are. Roll **2D6 + 16** to determine your character's age, or pick any age **16** or greater. For each year of your character's life past age **16**, roll **1D10**, check the chart below, and go to that section of the Lifepath. What happens there is the major event that shaped your character's life for that year. When you're done, come on back here and roll the next year's main event.

- |             |                                   |
|-------------|-----------------------------------|
| <b>1-3</b>  | <b>Big Problems, Big Wins</b>     |
| <b>4-6</b>  | <b>Friends &amp; Enemies</b>      |
| <b>7-8</b>  | <b>Romantic Involvement</b>       |
| <b>9-10</b> | <b>Nothing Happened That Year</b> |

## 4(a) Big Problems, Big Wins

Living on the Edge means taking big risks. This year, you took some serious chances. Did it pay off or did you go down in the street? Roll 1D10. On an even roll, you scored big. On an odd roll, you took a hit.

### DISASTER STRIKES!

#### Roll 1D10:

- 1 **Financial Loss or Debt:** Roll 1D10x100. You have lost this much in Eurodollars. If you can't pay this now, you have a debt to pay, in cash—or blood.
- 2 **Imprisonment:** You have been in prison, or possibly held hostage (your choice). Roll 1D10 for length of imprisonment in months.
- 3 **Illness or addiction:** You have contracted either an illness or drug habit in this time. Lost 1 pt of REF permanently as a result.
- 4 **Betrayal:** you have been backstabbed in some manner. Roll another D10. 1-3, you are being blackmailed. 4-7, a secret was exposed. 8-10, you were betrayed by a close friend in either romance or career (you choose).
- 5 **Accident:** You were in some kind of terrible accident. Roll 1D10. 1-4, you were terribly disfigured and must subtract -5 from your ATT. 5-6, you were hospitalized for 1D10 months that year. 7-8, you have lost 1D10 months of memory of that year. 9-10, you constantly relive nightmares (8 in 10 chance each night) of the accident and wake up screaming.
- 6 **Lover, friend or relative killed:** You lost someone you really cared about. 1-5, they died accidentally. 6-8, they were murdered by unknown parties. 9-10, they were murdered and you know who did it. You just need the proof.
- 7 **False Accusation:** You were set up. Roll 1D10. 1-3, the accusation is theft. 4-5 it's cowardice. 6-8 it's murder. 9 it's rape. 10, it's lying or betrayal.
- 8 **Hunted by the Law:** You are hunted by the law for crimes you may or may not have committed (your choice). Roll 1D10. 1-3, only a couple local cops want you. 4-6, it's the entire local force. 7-8 it's the State Police or Militia. 9-10, it's the FBI or equivalent national police force.
- 9 **Hunted by a Corporation:** You have angered some corporate honcho. Roll 1D10. 1-3, it's a small, local firm. 4-6, it's a larger corp with offices statewide. 7-8; it's a big, national corp with agents in major cities nationwide. 9-10; it's a huge multinational with armies, ninja and spies *everywhere*.
- 10 **Mental or physical incapacitation:** You have experienced some type of mental or physical breakdown. Roll 1D10. 1-3, it's some type of nervous disorder, probably from a bioplague—lose 1 pt. REF. On 4-7, it's some kind of mental problem; you suffer anxiety attacks and phobias. Lose 1 pt from your CL stat. 8-10, it's a major psychosis. You hear voices, are violent, irrational, depressive. Lose 1 pt from your CL, 1 from REF.

Go To **WHAT ARE YOU GONNA DO ABOUT IT?**

### YOU GET LUCKY

#### Roll 1D10:

- 1 **Make a Powerful Connection** in City Government. Roll 1D10. 1-4, it's in the Police Dept. 5-7, it's in the District Attorney's Office. 8-10, it's in the Mayor's Office.
- 2 **Financial Windfall:** Roll 1D10x100 for amount in Eurodollars.
- 3 **Big Score** on job or deal! Roll 1D10x100 for amount in Eurodollars.
- 4 **Find a Sensei (teacher)** Begin at +2 or add +1 to a Martial Arts Skill of your choice.
- 5 **Find a Teacher:** Add +1 to any INT based skill, or begin a new INT based skill at +2.
- 6 **Powerful Corporate Exec** owes you one favor.
- 7 **Local Nomad Pack befriends you.** You can call upon them for one favor a month, equivalent to a Family Special Ability of +2.
- 8 **Make a Friend on the Police Force.** You may use him for inside information at a level of +2 Streetwise on any police related situation.
- 9 **Local Boostergang likes you** (Who knows why. These are Boosters, right?) You can call upon them for 1 favor a month, equivalent to a Family Special Ability of +2. But don't push it.
- 10 **Find a Combat Teacher.** Add +1 to any weapon skill with the exception of Martial Arts or Brawling, or begin a new combat skill at +2.

Go back to **LIFE EVENTS AND ROLL THE NEXT YEAR.**

### WHAT ARE YOU GONNA DO ABOUT IT?

#### Choose or roll one:

- 1-2 Clear your name
- 3-4 Live it down and try to forget it.
- 5-6 Hunt down those responsible and *make them pay!*
- 7-8 Get what's rightfully yours
- 9-10 Save, if possible, anyone else involved in the situation.

Go back to **LIFE EVENTS AND ROLL THE NEXT YEAR.**

### 4b) Friends & Enemies

Living on the Edge means you don't do things halfway. Your friends are tight, and your enemies ruthless. If you're here, it's because your social life took a major turn (for the worse?) this year. Roll 1D10. On a 1-5, you made a friend. On a 6-10, you made an enemy.

#### MAKE AN ENEMY

You've gotten in someone's face. Enemies are a way of life in *Cyberpunk*, so don't skip this step. For each enemy, choose or roll sex on 1D10. EVEN=Male ODD=Female

This enemy is (choose or roll one):

- 1 Ex friend
  - 2 Ex lover
  - 3 Relative
  - 4 Childhood enemy
  - 5 Person working for you.
  - 6 Person you work for
  - 7 Partner or co-worker
  - 8 Booster gang member
  - 9 Corporate Exec
  - 10 Government Official
- Go to **THE CAUSE**

#### THE CAUSE

This enmity started when one of you (choose or roll one):

- 1 Caused the other to lose face or status
- 2 Caused the loss of a lover, friend or relative
- 3 Caused a major humiliation
- 4 Accused the other of cowardice or some other personal flaw
- 5 Caused a physical disability: (Roll 1D6. 1-2= lose eye. 3-4=lose arm. 5-6=badly scarred)
- 6 Deserted or betrayed the other
- 7 Turned down other's offer of job or romantic involvement
- 8 You just didn't like each other
- 9 Was a romantic rival
- 10 Foiled a plan of the other's

Go to **WHO'S FRACKED**

#### WHO'S FRACKED OFF?

Choose or roll one:

- 1-4 They hate you
  - 5-7 You hate them
  - 8-10 The feeling's mutual
- Go to **WHATCHA GONNA...**

#### WHATCHA' GONNA DO ABOUT IT?

If the two of you met face to face, the injured party would most likely (Choose or roll one):

- 1-2 Go into a murderous, killing rage and rip his face off!
  - 3-4 Avoid the scum
  - 5-6 Backstab him indirectly
  - 7-8 Ignore the scum
  - 9-10 Rip into him verbally
- Go to **WHAT CAN HE ..**

#### WHAT CAN HE THROW AGAINST YOU?

What kind of forces can your enemy put on the table to stop you? (Choose or roll one):

- 1-3 Just himself
- 4-5 Himself and a few friends
- 6-7 An entire Gang
- 8 A small Corporation
- 9 A large Corporation
- 10 An entire Government Agency

Go back to **LIFE EVENTS AND ROLL THE NEXT YEAR.**

**MAKE A FRIEND**  
You lucked out and made a new friend (a rare occurrence in the *Cyberpunk* world). For each new friend, choose or roll sex on 1D10: EVEN=Male ODD=Female Choose or roll your relationship to this friend:

- 1 Like a big brother/sister to you
- 2 Like a kid sister/brother to you
- 3 A teacher or mentor
- 4 A partner or co-worker
- 5 An old lover (choose which one)
- 6 An old enemy (choose which one)
- 7 Like a foster parent to you
- 8 A relative
- 9 Reconnect with an old childhood friend
- 10 Met through a common interest.

Go back to **LIFE EVENTS AND ROLL THE NEXT YEAR.**

Who is this person? Move over to **Personal Style (pg. 34)** and **Motivations (pg. 34)** and make a few rolls to find out what your friend or enemy is like.



**4c) Romantic Life**

There's more to life than just combat and bad breaks. Romance is also part of living on the Edge. If you're here, you had some romantic action as your major event this year. Start by finding out **HOW IT WORKED OUT**, below:

**HOW IT WORKED OUT**  
 Roll one, then go to that section:  
 1-4 Happy love affair (go back to **LIFE EVENTS**)  
 5 **TRAGIC LOVE AFFAIR**  
 6-7 **LOVE AFFAIR WITH PROBLEMS**  
 8-10 Fast Affairs and Hot Dates (go back to **LIFE EVENTS**)

**TRAGIC LOVE AFFAIR**  
 Choose or roll one:  
 1 Lover died in accident  
 2 Lover mysteriously vanished  
 3 It didn't work out  
 4 A personal goal or vendetta came between you  
 5 Lover kidnapped  
 6 Lover went insane  
 7 Lover committed suicide  
 8 Lover killed in a fight  
 9 Rival cut you out of the action  
 10 Lover imprisoned or exiled  
 Go To **MUTUAL FEELINGS**

**LOVE AFFAIR WITH PROBLEMS**  
 Choose or roll one:  
 1 Your lover's friends/family hate you  
 2 Your lover's friends/family would use any means to get rid of you  
 3 Your friends/family hate your lover  
 4 One of you has a romantic rival  
 5 You are separated in some way  
 6 You fight constantly  
 7 You're professional rivals  
 8 One of you is insanely jealous  
 9 One of you is "messing around"  
 10 You have conflicting backgrounds and families  
 Go back to **LIFE EVENTS AND ROLL FOR NEXT YEAR.**

**MUTUAL FEELINGS**  
 Choose or roll one:  
 1 They still love you  
 2 You still love them  
 3 You still love each other  
 4 You hate them  
 5 They hate you  
 6 You hate each other  
 7 You're friends  
 8 No feeling's either way; it's over  
 9 You like them, they hate you  
 10 They like you, you hate them  
 Go back to **LIFE EVENTS AND ROLL FOR NEXT YEAR**

Was it worth the pain? Move over to the **Personal Style (pg.34)** and the **Motivations Sections (pg.36)** and make a few rolls to find out what your lover was like and whether you'd do it all over again if he/she walked back into your life. Because with your luck, it might just happen.



**ROLES**  
**CHARACTERS**  
**LIFEPATH**  
**TASK & SKILLS**  
**WEAPONS**  
**ARMOR**  
**GEAR**  
**CYBERWEAR**  
**COMBAT**  
**MEDICAL**  
**NETRUNNING**

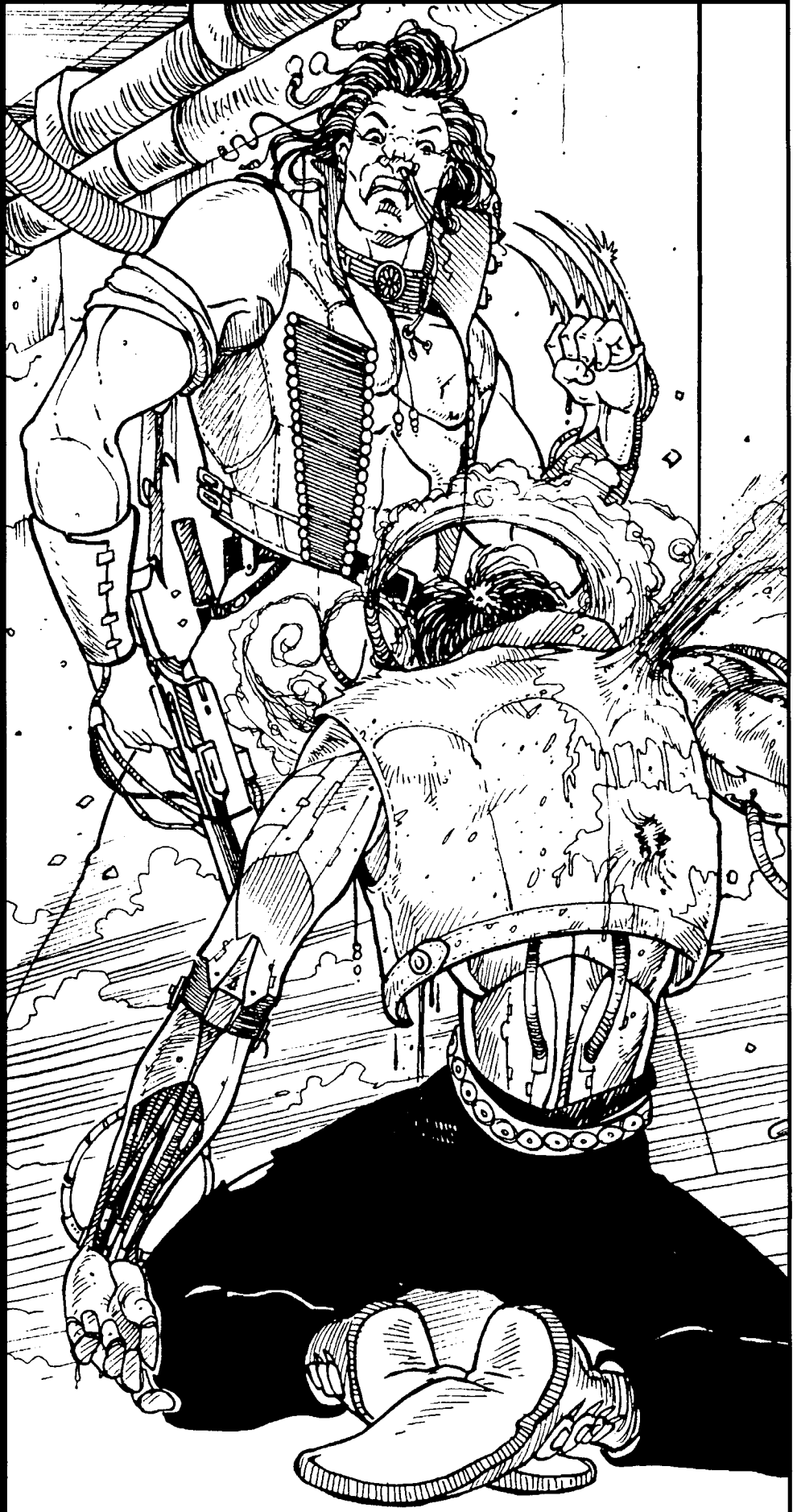

**"You say you've done this kinda thing before?"**  
**Silence. Then, "Yep."**  
**A long pause. Click. Rattle. Click.**  
**"You're sure?"**  
**"Yep."**  
**Long pause...Click. Whir. Click. "Uh...Ice?"**  
**" Ripper, shut up before I cross a wire and wipe out half**  
**the City in a thermonuclear accident."**  
**"Uh...right." Click. Whir. Rattle.**

**HOW LONG WILL IT TAKE?**

- Some Sample Times:  
 Fixing a simple electronic device ..... 5 min.  
 Fixing a complex electronic device ..... 20min.  
 Fixing a gun ..... 5 min.  
 Fixing a laser, taser or maser ..... 10 min.  
 Fixing a tire ..... 5-6 min.  
 Fixing an engine ..... 10-20 min.  
 Rebuilding an engine ..... 2 days  
 Looking for a hidden object ..... 2-5 min.  
 Opening a simple mechanical lock ..... 1-2 min.  
 Opening a complex mechanical lock ..... 5-10 min.  
 Opening a simple electronic lock ..... 3-4 min.  
 Opening a complex electronic lock ..... 5-10 min.  
 Searching a database ..... 5-20 min.  
 Designing a cyberdeck ..... 1-3 days  
 Putting on a disguise ..... 3 min.

SECTION  
**4 WORKING**

**Skill Checks**

Most of the time, your character will be able to do most ordinary things without difficulty; walk, talk, open a can of *Protein Food Complex 35* without gagging. But certain things will require that the character make a **Skill Check** to see if he can actually do what he wanted to.

Next, if you have any one Skill directly relating to the task at hand, add that skill to the stat. You may apply only one Skill to a task at any time. The subject of Skills (and how you get them) is covered on pages 42 through 54, but right now, we're just inter-facing you with the concept of tasks.

**Ref-Set Difficulties**

Each task is rated by the Referee from **Easy** to **Nearly Impossible**. Each rating has a corresponding numerical value, called a **Difficulty**.

Finally, roll 1D10 and add the combined total of your die roll, your Stat, and your selected Skill. Compare your total with the Task's Difficulty (as determined by the Referee). **If your total is equal or higher, you have succeeded; on a lower roll, you have failed.**

TASK DIFFICULTIES	
Easy .....	10+
Average .....	15+
Difficult .....	20+
Very Difficult .....	25+
Nearly Impossible .....	30+

*Here's an example: Johnny Silverhand needs to break into a locked room, a task the Referee considers to require some training. As such, it has a Difficulty of 15. Johnny's most applicable stat is Technical, because this is a Task that requires manipulating a mechanical object. Johnny isn't much of a techie (his Tech stat is only +3, enough to fix his guitar strings and plug in his amp). But Johnny also picked up Pick Lock +3 as one of his early Pickup skills. This gives him a Base Ability of 6. Johnny will need to roll at least a 9 to pick this lock.*

**Giving It Your Best Shot**

When making a Skill Check, first, determine which of your stats is the most appropriate to use to perform the action. For example, if you were trying to stand on your head, REF would be best. If you were deciphering a code, INT would be the most appropriate.

**FEELIN' LUCKY, PUNK?**

Remember; you can use points from your Luck Stat to "boost" a roll. You can use any or all of your LUCK to do this, up to the full amount per game session, by announcing your intention to use LUCK points before making the roll.

## TASKS & SKILLS

### Difficulty Modifiers

Complex Repair .....	+2
Very Complex Repair .....	+4
"It's Never Been Done Before" .....	+6
Don't have the right parts .....	+2
Don't have the right tools .....	+3
Unfamiliar tools, weapon or vehicle .....	+4
Under stress .....	+3
Under attack .....	+3 to +4
Wounded .....	+2 to +6
Drunk, drugged or tired .....	+4
Hostile Environment .....	+4
Very Hostile Environment .....	+6
Lack of instructions for task ..	+2
All the other characters are "kibbitzing" while you're trying to do the task .....	+3
Has never performed this task before .....	+1
Difficult Acrobatics involved ..	+3
Very Difficult Acrobatics involved .....	+4
Impossible Acrobatics involved .....	+5
Information hidden, secret or obscure .....	+3
Well-hidden clue, secret door, panel, etc. ....	+3
Complex program .....	+3
Very complex program .....	+5
Complex lock .....	+3
Very complex lock .....	+5
Target on guard or alerted ...	+3
Brightly lit area .....	+3
Insufficient light .....	+3
Pitch Blackness .....	+4
Trying to perform secretive task while under observation .....	+4



### Opposed Tasks

If you are making an attempt against another player character, the opposing player will combine his most applicable stat, skill and 1D10 roll. On an equal or higher roll, the defending player wins.

### Difficulty Modifiers

Difficulty Modifiers are values which are added to the difficulty of a task, reflecting adverse conditions or extra problems. Modifiers work best when you are dealing with very ticklish or picky situations; things where life and death tasks must be performed. At these times, players will want every advantage they can get, and a simple decision like "The task is Very Difficult." will create more friction than its worth. At these times, you will probably want to make the steps of the task clear by creating a Difficulty through stacking modifiers. In addition, modifiers allow you, as the Referee, to determine the relative difficulty of doing something and the effect of prevailing conditions.

### Automatic Failure, Critical Success

On a natural die roll of **1**, you have failed. Roll an additional 1D10 and check the result

on the **Fumble Table** (pg. 43) to see what (if anything) happens.

On a natural roll of **10**, you have had a **critical success**. Roll an additional 1D10 and *add* it to your original roll. This is when you get lucky and manage to pull off something you have no chance in Hades of doing normally.

**Even the best of us blows it sometimes. Even you.**  
— *The Management*

## Skills

Skills are used to enhance your ability to perform certain tasks. They represent things you've specifically taken the time to learn and possibly master, (as opposed to your stats, which only indicate a basic, natural ability at doing something).

For example, if you had very good REF, you would probably pick up driving a car very easily. But you would not know how to drive a car until you had learned the skill of *Driving*. Each skill is related in some way to one of your basic stats. For example, the skill of *Handgun* is always related to the character's REF stat. Skills are always rated from 0 to 10, with 1 being a novice level of knowledge, and 10 being a master's level of ability. Skills are described on pgs. 46 to 53, along with all pertinent notes and



FUMBLE TABLE

AREA	RESULT OF ROLL
<b>REFLEX (Combat)</b>	1-4 No fumble. You just screw up. 5 You drop your weapon. 6 Weapon discharges (make reliability roll for non-autoweap.) or strikes something harmless. 7 Weapon jams (make reliability roll for non-autoweap.) or imbeds itself in the ground for one turn. 8 You manage to wound yourself. Roll for location. 9-10 You manage to wound a member of your own party.
<b>REFLEX (Athletics)</b>	1-4 No fumble. You just mess up and make an idiot of yourself. 5-7 You fail miserably. Take 1 point in minor damage (sprain, fall, stumble), plus make a Save vs. Stun. 8-10 You fail abysmally. If a physical action, take 1D6 in damage from falling or strained muscles. Also make a roll vs Stun at -1.
<b>TECH (Repair or create)</b>	1-4 No fumble. You just can't get it together. 5-7 You not only fail, you make it worse! You drop the tools you're working with, or you lose your grip and damage the thing you're working with even more. Raise the Difficulty by 5 points and try again. 8-10 Wow. Did you ever blow it! You damaged the device or creation beyond repair. Buy a new one.
<b>EMP (Convince, Fast talk, Seduce)</b>	1-4 No fumble. They just won't buy it. 5-6 So much for your people skills. You not only don't convince them; you leave them totally cold (-4 to your next EMP die roll) to any other suggestion you might have. 7-10 Yow! You blew it royally. You not only didn't convince them, but now they're actually, violently opposed to anything you want to do. Roll 1D10. On a 1-4, they actually attempt to do you physical harm.
<b>INT (Figure out, Notice, catch a clue)</b>	1-4 No fumble; You just don't know how to do it. You don't know what's going on. You carry on, oblivious to higher concerns. 5-7 You don't know anything about what's going on, and you haven't a clue about how to do anything about it. Make a Convince check at -2 to see if anyone else notices how dumb you are. 8-10 Wow, are you oblivious. You not only don't know what's going on or anything about the subject, but <u>everyone</u> knows how ignorant you are.

**Important:** It is required that one of your character's Career Skills be the Special Ability for his or her class (pg. 46). These Skills are unique to the class and reflect abilities and resources only that particular class possesses. Examples are the *Authority of Cops* which allows them to use the weight and powers of the Law or the *Charismatic Leadership* which allows a Rockerboy to convince a crowd to get down and party — or get out and riot. The number of points you put into your Special Ability (up to, but not greater than 10) reflects your position in your chosen field and the development of your unique career skill. Because of this, your Special Ability also determines how much money you have to start with (page 58).

*"I used to think I could get by with a razor smile and a fist fulla chips. But if you're gonna rock and roll, you have to know how to squeeze every last drop of pain out of your instrument. And that takes skill, choomba. Not chips..."*  
—Johnny Silverhand

Obviously while spreading those Career Points around

explanations. In addition, players may opt to invent their own Skills (see Inventing New Skills, pg. 54).

**Starting Skills**

There are two types of starting Skills: **Career Skill Packages** and **Pickup Skills**:

The Career Skill Package is a group of skills that are known by your character as part of his or her Career. They're basics—Rockers know how to play instruments, Solos know how to shoot guns, etc. **A starting character receives 40 points to distribute among his 10 Career Skills. He may not use these points on his Pickup Skills, although he can choose to use future Improvement Points (pg 44) to improve a Career Skill at any later time. He does not have to put points into all of his Career Skills (but it's a good idea—you never know).**

it's going to be pretty tempting to make yourself a wealthy Superstar, but remember a Rocker with lots of *Charismatic Leadership* and no performance skills will find that things can get ugly fast. They may love you but they paid 60 eb for those tickets so you'd better be smokin'.

*Example: As a Rockerboy, Johnny Silverhand began with the following package:*

- Charismatic Leadership** ..... +6
- Notice ..... +3
- Perform ..... +5
- Style ..... +4
- Composition ..... +4
- Brawling ..... +2
- Play Instrument ..... +5
- Streetwise ..... +3
- Persuasion ..... +5
- Seduction ..... +3
- TOTAL** ..... **40**

## TASKS & SKILLS

### CREATING NEW CHARACTER ROLES

Pick any nine skills (not Special Ability Skills) to be your Career Skills. These should be skills that directly relate to what the character does for a living; a Rockerboy, for example, wouldn't have Brain Surgery as a Career Skill. Now pick or create a Special Ability with your Ref's help. Divide 40 points between these ten skills.

#### MODEL/ACTRESS

**Pose**  
Notice  
Personal Grooming  
Wardrobe & Style  
Education  
Photo & Film  
Seduction  
Persuasion  
Perform  
Social

#### POLITICIAN

**Charismatic Leadership**  
Notice  
Education  
Wardrobe & Style  
Composition  
Persuasion  
Oratory  
Social  
History  
Library Search

## CAREER SKILLS

### SOLO

**Combat Sense**  
Awareness/Notice  
Handgun  
Brawling or Martial Arts  
Melee  
Weapons Tech  
Rifle  
Athletics  
Submachinegun  
Stealth

### NOMAD

**Family**  
Awareness/Notice  
Endurance  
Melee  
Rifle  
Drive  
Basic Tech  
Wilderness Survival  
Brawling  
Athletics

### ROCKERBOY

**Charismatic Leadership**  
Awareness/Notice  
Perform  
Wardrobe & Style  
Composition  
Brawling  
Play Instrument  
Streetwise  
Persuasion  
Seduction

### NETRUNNER

**Interface**  
Awareness/Notice  
Basic Tech  
Education  
System Knowledge  
CyberTech  
Cyberdeck Design  
Composition  
Electronics  
Programming

### CORPORATE Resources

Awareness/Notice  
Human Perception  
Education  
Library Search  
Social  
Persuasion  
Stock Market  
Wardrobe & Style  
Personal Grooming

### TECHIE

**Jury Rig**  
Awareness/Notice  
Basic Tech  
CyberTech  
Teaching  
Education  
Electronics  
Any three other  
Tech Skills (Gyro, Aero,  
Weapons, Elect. Security)

### MED TECH

**Medical Tech**  
Awareness/Notice  
Basic Tech  
Diagnose  
Education  
Cryotank Operation  
Library Search  
Pharmaceuticals  
Zoology  
Human Perception

### MEDIA Credibility

Awareness/Notice  
Composition  
Education  
Persuasion  
Human Perception  
Social  
Streetwise  
Photo & Film  
Interview

### COP

**Authority**  
Awareness/Notice  
Handgun  
Human Perception  
Athletics  
Education  
Brawling  
Melee  
Interrogation  
Streetwise

### FIXER

**Streetdeal**  
Awareness/Notice  
Forgery  
Handgun  
Brawling  
Melee  
Pick Lock  
Pick Pocket  
Intimidate  
Persuasion

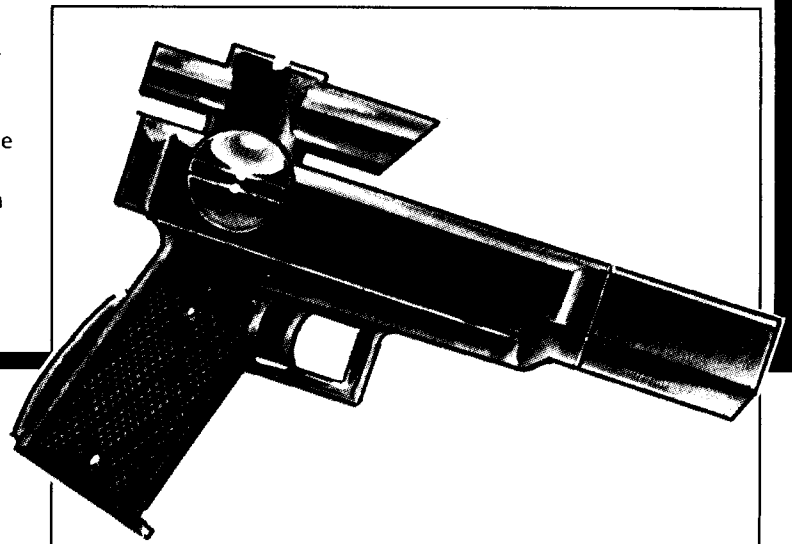

**MASTER SKILL LIST**

**SPECIAL ABILITIES**

- Authority (Cop) ..... [ ]
- Charis. Leadership (Rocker) ..... [ ]
- Combat Sense (Solo) ..... [ ]
- Credibility (Media) ..... [ ]
- Family (Nomad) ..... [ ]
- Interface (Netrunner) ..... [ ]
- Jury Rig (Techie) ..... [ ]
- Medical Tech (Medtechie) ..... [ ]
- Resources (Corp) ..... [ ]
- Streetdeal (Fixer) ..... [ ]

**ATTR**

- Personal Grooming ..... [ ]
- Wardrobe & Style ..... [ ]

**BODY**

- Endurance ..... [ ]
- Strength Feat ..... [ ]
- Swimming ..... [ ]

**COOL/WILL**

- Interrogation ..... [ ]
- Intimidate ..... [ ]
- Oratory ..... [ ]
- Resist Torture/Drugs ..... [ ]
- Streetwise ..... [ ]

**EMPATHY**

- Human Perception ..... [ ]
- Interview ..... [ ]
- Leadership ..... [ ]
- Seduction ..... [ ]
- Social ..... [ ]
- Persuasion & Fast Talk ..... [ ]
- Perform ..... [ ]

**INT**

- Accounting ..... [ ]
- Anthropology ..... [ ]
- Awareness/Notice ..... [ ]
- Biology ..... [ ]
- Botany ..... [ ]
- Chemistry ..... [ ]
- Composition ..... [ ]
- Diagnose Illness ..... [ ]
- Education & Gen.Know ..... [ ]
- Expert ..... [ ]
- Gamble ..... [ ]
- Geology ..... [ ]
- Hide/Evade ..... [ ]
- History ..... [ ]
- Know Language (choose one) .. [ ]
- Library Search ..... [ ]

- Mathematics ..... [ ]
- Physics ..... [ ]
- Programming ..... [ ]
- Shadow/Track ..... [ ]
- Stock Market ..... [ ]
- System Knowledge ..... [ ]
- Teaching ..... [ ]
- Wilderness Survival ..... [ ]
- Zoology ..... [ ]

**REF**

- Archery ..... [ ]
- Athletics ..... [ ]
- Brawling ..... [ ]
- Dance ..... [ ]
- Dodge & Escape ..... [ ]
- Driving ..... [ ]
- Fencing ..... [ ]
- Handgun ..... [ ]
- Heavy Weapons ..... [ ]
- Martial Art (choose types) ..... [ ]
- Melee ..... [ ]
- Motorcycle ..... [ ]
- Operate Hvy. Machinery ..... [ ]
- Pilot (Gyro) ..... [ ]
- Pilot (Fixed Wing) ..... [ ]
- Pilot (Dirigible) ..... [ ]
- Pilot (Vect.Thrust Vehicle) ..... [ ]
- Rifle ..... [ ]
- Stealth ..... [ ]
- Submachinegun ..... [ ]

**TECH**

- Aero Tech ..... [ ]
- AV Tech ..... [ ]
- Basic Tech ..... [ ]
- Cryotank Operation ..... [ ]
- Cyberdeck Design ..... [ ]
- CyberTech ..... [ ]
- Demolitions ..... [ ]
- Disguise ..... [ ]
- Electronics ..... [ ]
- Elect. Security ..... [ ]
- First Aid ..... [ ]
- Forgery ..... [ ]
- Gyro Tech ..... [ ]
- Paint or Draw ..... [ ]
- Photo & Film ..... [ ]
- Pharmaceuticals ..... [ ]
- Pick Lock ..... [ ]
- Pick Pocket ..... [ ]
- Play Instrument ..... [ ]
- Weaponsmith ..... [ ]

**A HOT TIP**

Photocopy this page (it's okay, we said so, as long as it's for personal use). It makes a great worksheet for keeping track of skills

### Pickup Skills

**Pickup Skills** are skills the character has learned in the course of knocking around, living his or her life. Characters determine their starting points for these skills by adding their REF and INT Stats.

*For example: Johnny's REF is 9 and his INT is 7. Johnny has 16 points to spend on Pickup Skills.*

**Pickup Skill points may not be used to increase your character's Career Skills!**

## Skill Descriptions

Following are descriptions of all *Cyberpunk* Skills. Numbers in parentheses next to skill names are Difficulty Modifiers. To reflect complex and difficult-to-learn skills, the number of improvement points necessary to go up one level must be multiplied by the Difficulty Modifier. See pg. 43 for details.

### Special Abilities

These are skills useable only by specific character roles; for example, Charismatic Leadership can only be used by Rockers.

**Authority (Cops):** The ability to intimidate or control others through your position as a lawman. This attribute represents the Cop's ability to call on the forces of the Law and Government to get what he wants. Cops can use *Authority* to question suspects, arrest wrongdoers, and defend innocents. Backed by the power of *Authority*, a cop can arrest, detain, confiscate and enter nearly anywhere, as long as he has the proper arrest or search warrants to back his play. However, authority is only as good as the guy holding the badge—if the cop appears uncertain of his *Authority*, there's a good chance he'll get nailed by the people he's trying to confront. The higher your *Authority*, the more able you are to face down criminals, particularly high level mobsters and officials. *Authority* is applied to your Cool stat.

**Charismatic Leadership (Rockers):** This skill allows the Rocker to sway crowds equal to his level squared times 200. This ability

(added to your Cool stat) allows the Rocker to control, incite and charm large number of people through his or her performance skills. When under the Rocker's control, this group can easily be persuaded to act on his suggestions; for example, a Rocker could convince a concert crowd to riot in the streets or attack a heavily fortified police line. *Charismatic Leadership* will only work with groups of ten or more people as it is primarily a mob leadership ability. The higher your *Charismatic Leadership*, the larger a crowd you can control and the more direct and complex the instructions you can get them to follow. For example, a Level +3 *Leadership* could incite a nightclub crowd to get rowdy. A Level +5 or +6 could provoke a concert crowd of thousands to trash a neighborhood, if the area wasn't too far from the hall. At Level +9, and higher, you have the same sort of mesmeric ability as an Adolph Hitler—you can raise armies, start movements, and destroy nations.

**Combat Sense (Solos):** This ability is based on the Solo's constant training and professionalism. Combat Sense allows the Solo to perceive danger, notice traps, and have an almost unearthly ability to avoid harm. Your Combat Sense gives you a bonus on both your Awareness skill and your Initiative equal to your level in the Combat Sense skill.

**Credibility (Medias):** This is the ability to be believed: by your viewers, by the police, by important and powerful people. This is critical to getting your story heard and acted upon, as well as convincing people to tell you things, give you information, or get you into where the story is really happening. The higher your *Credibility*, the more people you can convince, and the easier it is to convince high level authorities of the truth of your information. With a level +3 *Credibility*, you can convince most people of minor scandals. With a level +5 or +6, you can convince local officials of military atrocities, undercover dealings and other front page stuff. At level +9, you can successfully expose a scandal of Watergate proportions, or convince the President of the EuroMarket Finance Board that aliens are secretly influencing world leaders. *Credibility* applies to your INT stat.

**Family (Nomad):** This is the ability to call upon the resources and help of any of the members of the Nomad's large, extended tribal family. This can be in the form of

weapons, cash, information, or a small army of relatives. The threat of a Nomad family's vengeance may in itself stop harm to the Nomad. The higher your *Family* ability, the more important you are to the Family and the more help you can call upon. With a *Family* status of +2, you might be able to get several of the Pack to help you wreck a town, for example. With a status of +7 or +8, you are able to make major Pack decisions and lead troops. At +10, you may be the Leader of your Pack. *Family* is applied to your Intelligence stat.

**Interface (Netrunner):** This skill reflects the Netrunner's ability to manipulate Interface programs, and is the Skill used when operating Menu functions such as Locate Remote, Run Software, Control Remote, Downlink, Load, Create and Delete. Other players can enter the Net, but cannot use the Menu. Interface is based on the INT Stat. Note for *Cyberpunk* / players—you may elect to swap your original INT and REF stats for characters generated with the old rule.

**Jury Rig (Techie):** This general repair skill allows the Techie to temporarily repair or alter anything for 1D6 turns per level of skill. This is not a permanent repair; after the elapsed time, the jury rig will break down.

**Medical Tech (Medtech):** This is the skill used to perform major surgery and medical repairs. For more descriptions of this skill in action, see *Trauma Team*, pg. 116.

**Resources (Corporate):** This represents the Corporate's ability to command corporation resources. It is used as a persuasion skill, based on the scale of resources requested. This could include bodyguards, weapons, vehicles, buildings, money, etc. Obviously, the more powerful the Corporate, the more he can call upon at any one time. Your level of *Resources* determines exactly how much you can request from the Corporation without overreaching yourself. A *Resource* ability of +2 might get you access to a Company car. An ability of +6 might allow you to use a Company jet or hire a Solo team from the Corporate Security Division. A *Resource* of +9 would allow you access to almost all levels of the Corporation, as well as the ability to requisition almost any Company resource. Your *Resource* ability is applied to your INT stat.

**Streetdeal (Fixer):** This is the ability to



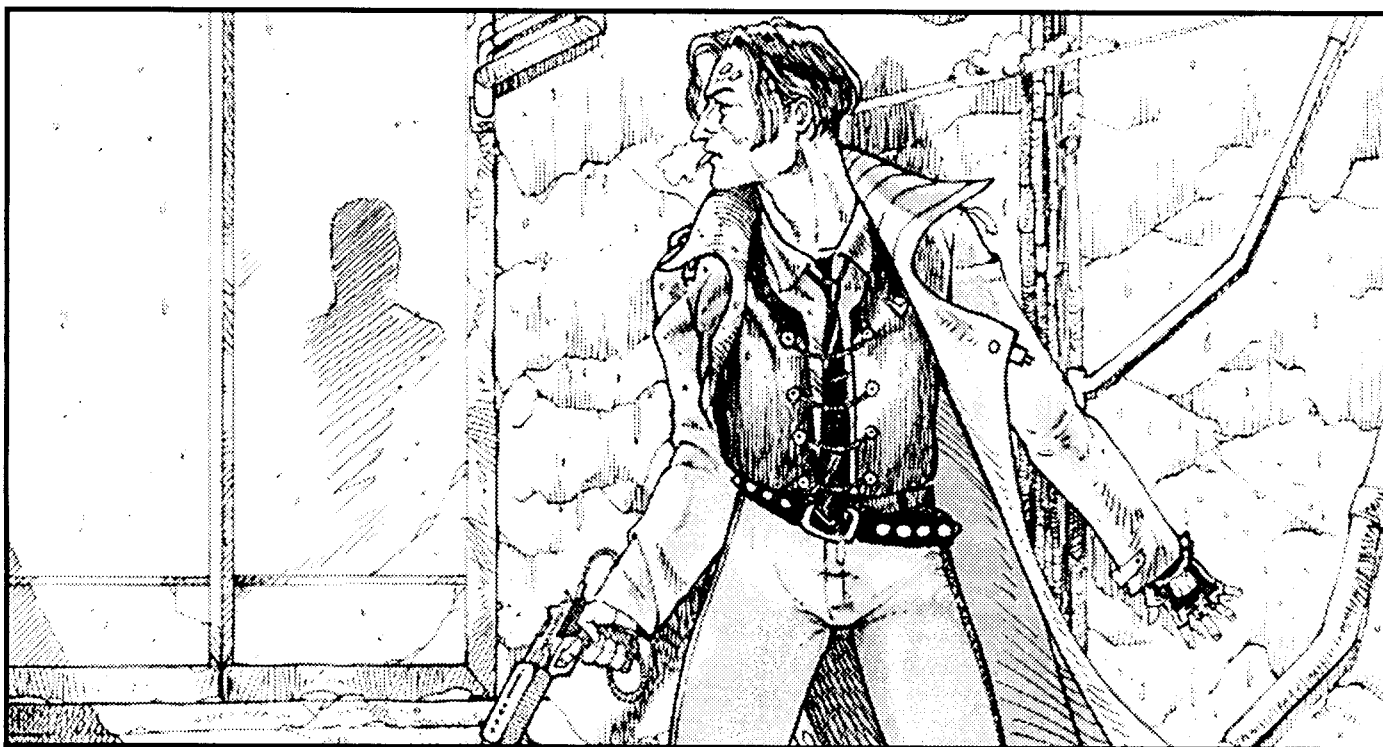

deal with the underground information network. With *Streetdeal*, a Fixer can uncover rumors and information, locate missing persons or things, put gossip out on the Street, pick up clues and score big deals. The higher your *Streetdeal* ability, the more information you can gather about things happening around you, the more informants you have, and the more secretive the information you can dig up. A level +3 *Streetdeal* can get you contacts for weapons, tools, or minor illegal operations. At level +5, you can penetrate the secrets of all but the most powerful crime families. At level +9, you are the equivalent of a Mafia crimelord yourself, privy to every secret that's on the Street. Apply *Streetdeal* to your Cool stat.

### Attractiveness Skills

**Personal Grooming:** This is the skill of knowing proper grooming, hair styling, etc., to maximize your physical attractiveness. Use of this skill allows players to increase their Attractiveness, and thus their chances of successful Relationships or Persuasions. A basically good looking person would be at +2. A fashion model might have a *Personal Grooming* of +5 or +6. At +8 or better, you could be a major fashion model, film star, or trendsetter. You are always "together". And you know it.

**Wardrobe & Style:** The skill of knowing

the right clothes to wear, when to wear them, and how to look cool even in a spacesuit. With a *Wardrobe* of +2 or better, you are good at choosing clothes off the rack. At +6, your friends ask you for wardrobe tips, and you never buy anything off the rack. At +8 or better, you are one of those rare people whose personal style influences major fashion trends.

### Body Type Skills

**Endurance:** This is the ability to withstand pain or hardship, particularly over long periods of time, by knowing the best ways to conserve strength and energy. *Endurance* Skill checks would be made whenever a character must continue to be active after a long period without food, sleep or water.

**Strength Feat:** The user of this skill has practiced the art of bending bars, crushing objects, ripping phone books apart and other useful parlor tricks. At +2 you can crush cans, rip thin books in half, and bend thin rods. At +8, no phonebook is safe, you can bend thin rebar, and snap handcuffs. At +10, you can bend prison bars, rip up the Gutenberg Bible, and dent car fenders with one blow.

**Swimming:** This skill is required to know how to swim (see *Athletics* for details).

### Cool/Willpower Skills

**Interrogation:** The skill of drawing information from a subject and forcing his secrets into the open. An *Interrogation* of +2 or better will allow you to infallibly find out if your boyfriend is lying to you. At +5, you are a professional level interrogator—equivalent to a skilled detective grilling a suspect. Mike Wallace of 60 Minutes has an *Interrogation* of +9, allowing him to make even the most powerful people squirm.

**Intimidate:** The skill of getting people to do what you want by force of personality or physical coercion. At +3, you can frighten almost any typical citizen, politician or low-level thug. At +6, you can intimidate Sylvester Stallone or any moderate "tough guy". At +9, you could intimidate Arnold Schwarzenegger.

**Oratory:** The skill of public speaking. At +2, you can wing high school speech contests. At +6, you can be paid to speak in public. At +10, you are capable of delivering a speech to rival Kennedy's "Ich Bin Ein Berliner" or Lincoln's Gettysburg Address. Rockers with an *Oratory* Skill of +6 or better can add +1 when using their *Charismatic Leadership* ability.

**Resist Torture/Drugs:** Characters with this skill are especially toughened against in-

terrogation, torture and mind control drugs. A successful use of this skill will automatically increase the difficulty of any *interrogation* attempt made by another party by one level.

**Streetwise:** The knowledge of the “seamy” side of life—where to get illegal and contraband things, how to talk to the criminal element, and avoiding bad situations in bad neighborhoods. With a *Streetwise* of +2 or better, you can get “hot” items, score drugs, etc. A *Streetwise* of +5 would allow you to arrange a murder contract, know a few mobsters who might owe you favors, and be able to call on muscle when you need it. At +8 or better, you could become a major crimelord yourself and skip the middlemen.

### Empathy Skills

**Human Perception:** The skill of detecting lies, evasions, moods and other emotional clues from others. At +2, you can usually tell when you’re not getting the whole truth. At +6, you can detect subtle evasions and mood swings. At +8, you can not only detect subtle emotional clues, but can usually tell what the subject is hiding in a general way.

**Interview:** The skill of eliciting interesting anecdotes from an interview subject. This information will be of a more non-specific and personal nature rather than specific knowledge (distinguishing this skill from the skill of *Interrogation*, where the user is trying to extract exact information. Example: Barbara Walters interviews, Mike Wallace interrogates). At +3 or better, the subject will usually tell you only information relating to what he/she is well known for. At +6 or better, the subject will tell you anecdotes about the past, pontificate about favorite interests and philosophies, etc. At +9 or better, he/she tells you everything—including personal information about their illegitimate son, the time they stole a cookie at age 4, and the fact that no one ever loved them.

**Leadership:** The skill of leading and convincing people to follow you. A leader with a skill of +2 can manage a small office successfully and be respected for it. A leader with a skill of +4 or better can lead a small band of troops into battle and not get backshot. A leader with a skill of +7 or better can lead the entire Gamelon Empire into battle and look good doing it. James

Kirk of *Star Trek* has a *Leadership* of +11, but you never will.

**Seduction:** The skill of forming and maintaining romantic relationships (this includes your abilities as a lover). This skill may be used to determine whether or not players can form relationships with other non-player characters and the intensity of these relationships. In certain cases, Referees may want to average this skill with a player’s *Attractiveness* to get a more realistic outcome.

**Social:** The ability to deal with social situations, like knowing the right fork to use or when not to tell the joke about the farmer’s daughter and the travelling cyberware salesman. A *Social Skill* of +2 or better will allow you to get by at any fine restaurant or social function. At +5, you can lunch with the President with aplomb. No social situation will faze you, no matter what. At +8 or above, you can lecture Emily Post on what’s proper.

**Persuasion & Fast Talk:** The ability to talk others into doing what you want. This may be used individually or on large groups. At +3, you can win most debates or convince your girlfriend that the blonde you were with was your sister. At +5, you are a smooth talker of professional caliber. Ronald Reagan has a *Persuasion* of +7. Hitler had a *Persuasion* of +9.

**Perform:** The skill of trained acting, singing, etc. A trained performer of +4 or greater can successfully sing for payment at weddings or small clubs. Performers +6 or greater will be considered to be of professional caliber, and may have lucrative contracts and fans. Performers of +9 or greater are of “star” caliber, have a large number of fans, and may be recognized on the street.

### Intelligence Skills

**Accounting:** The ability to balance books (or create false books), juggle numbers, create budgets and handle day to day business operations.

**Anthropology:** The knowledge of human cultures, habits and customs. Unlike *Streetwise* (which covers only the cultures and customs of the Street), or *Social* (which covers only what you should do in a given situation), *Anthropology* covers general customs and background of a culture. For

example, with *Streetwise*, you know what alleys to avoid and what gangs are dangerous. With *Social*, you know the proper forms of address for a high ranking Japanese *zaibatsu* head. With *Anthropology*, you know that the customs of a N’Tanga tribesman require that a young man kill a lion in order to be accepted as an adult male.

**Awareness/Notice:** This is the equivalent of a “trained observer” skill, allowing characters to notice or be aware of clues, shadows and other events. With an *Awareness* of +2 you will usually spot small pieces of paper with notes on them, doors left ajar, and obvious expressions of lying or dislike. An *Awareness* of +5 or better allows you to spot fairly well hidden clues, notice small changes in expression, and fairly sophisticated attempts to “shadow” you. With an *Awareness* of +8 or greater, you routinely perform the sorts of deductive reasoning seen in the average TV cop show (“The murderer was left handed because this knife has a specialized handle”). Sherlock Holmes has a +10 *Awareness*. Players without this skill may only use their Intelligence Stat.

**Biology:** General knowledge of animals, plants, and other biological systems. At level +3, you know most types of common animals, plants. At +6, you have a general understanding of genetics, cellular biology, etc. At +10, you can perform most bio-lab procedures, including gene mapping and splicing.

**Botany:** The general knowledge of plants and plant identification. At level +3, you know most common plants and can identify which ones are dangerous and why. At a +6, you can identify most important plants found worldwide and have a working knowledge of their uses. At +8, you have the equivalent of a doctorate in Botany and know all about rare poisons, exotic orchids and other useful plants.

**Chemistry:** The required skill for mixing chemicals and creating various compounds. A level +2 *Chemistry* is equal to high school chemistry. A level +4 is equal to a trained pharmacist or college level chemist. A +8 is a trained laboratory chemist.

**Composition:** The required skill for writing songs, articles, or stories. A *Composing Skill* of +4 or greater gives your character the ability to produce salable work. A Skill of +8

or more produces work of such a high caliber that the creator may have a strong literary following and not a little critical acclaim.

**Diagnose Illness:** The skill of clinically diagnosing symptoms and medical problems. A +3 is the equivalent of a high school nurse—you can recognize most common injuries and complaints. At +6, you would be equivalent to a trained intern; you can recognize many uncommon illnesses and know how to treat most common ones. A +9 is the equivalent of a skilled diagnostician; other physicians come to you to get a diagnosis.

**Education & General Knowledge:** This skill is the equivalent of a basic public school education, allowing you to know how to read, write, use basic math, and know enough history to get by. In effect, it is a “lore” or trivia skill. A level of +1 is a basic grade school education. A skill of +2 is equal to a high school equivalency. A *Knowledge* Skill of +3 is equal to a college education, +4 or higher is equal to a Masters or Doctorate. At +7, you are an extremely well-educated person, and are asked to play Trivial Pursuit a lot. At +9 and above, you are one of those people who knows a lot about everything (and hopefully has the good sense to keep his mouth shut).

**Expert:** You may use this skill to be an expert on one specific subject, such as rare postage stamps, obscure weapons, a foreign language, etc. At +3, you are the local expert. At +6, you know enough to publish a few books on the subject. At +8 or better, your books are recognized as major texts on the subject, and you could do the talk-show circuit if you wanted to.

**Gamble:** The skill of knowing how to make bets, figure odds, and play games of chance successfully. As any professional gambler knows, this is not a luck skill. At +2, you are the local card shark at the Saturday night poker game. At +6, you can make a living at the tables in Vegas and Monte Carlo. At +9 or better, you can take on James Bond at roulette and stand a good chance of breaking the bank.

**Geology:** A functional knowledge of rocks, minerals and geologic structures. At +3, you can identify most common rocks and minerals. At +6, you have the equivalent of a college degree in Geology and can identify minerals and geological structures with ease. At +8, you can teach geology in high school.

**Hide/Evade:** The skill of losing pursuers, covering tracks and otherwise evading people on your trail. At +3, you can lose most booster-

gangers on the rampage. At +6, you can ditch cops and private eyes. At +8, you can ditch most Solos.

**History:** The knowledge of facts and figures of past events. In game play, this might be used to determine if a character is familiar with a particular clue related to a past event. At +2, you have the equivalent of a grade school history education. At +6, you would have the equivalent of a college grasp on the subject. At +8, you could teach history in high school. At +9, you may have written a few of the most oft-used texts on a particular historical personage or epoch.

**Know Language:** The knowledge of a foreign tongue. At +2, you can “get by” with speaking the language. At +3, you can actually read a written form of it. At +6 and above, you are fairly fluent, although no native will be fooled by your ability. At +8 and above, you speak and read the language like a native.

Each language known requires a separate *Know Language* Skill, however, one may use the knowledge of a particular Language with up to 1/2 (round down) proficiency with any language in the same linguistic family (example: knowing Cantonese at +4 will give you the ability to understand and speak Mandarin at +2).

**Library Search:** The skill of using databases, DataTerms™, libraries and other compiled information sources to find facts. With a skill of +2 you can use most simple databases. With a skill of +6, you can easily access the Library Congress. At +9, you can comprehend almost any public database and find very obscure facts.

**Mathematics:** The skill of understanding calculations and mathematical formulas. At +3, you have the ability to add, subtract, divide and multiply. At +4, you can do algebra and geometry. At +6, you can perform calculus. At +9 you can deduce your own mathematical formulas.

**Physics:** The ability to calculate physical principles, such as gas pressures, mechanical energies, etc. This skill requires a basic *Mathematics* Skill of +4.

**Programming:** The required skill to write programs and to re-program computer systems. This skill does not allow players to actually do repairs on a computer (this requires *Electronics*). With a *Programming* Skill of +1, you can do simple EBASIC programs. A *Programming* Skill of +3 or better allows you to know some higher

## LINGUISTIC FAMILIES

*Languages group together into “families” sharing many common root words and sentence structures. Once you’ve learned one language in a linguistic family, you may learn any other language in a related linguistic family at -1 to the normal IP cost. The values in parentheses are the IP multipliers for learning the languages in that family.*

### AFRICAN (2)

Bantu, Fante, Ashanti, Kongo, Zulu, Swahili, Blackfolk

**BALTIC (2)** Lithuanian, Estonian, Latvian, Finnish

### CELTIC (2)

Gaelic, Welsh, Breton

### FARSI (2)

### GERMANIC (1)

Danish, Dutch, English, German, Norwegian, Swedish, Yiddish

### GREEK (2)

### JAPANESE (2)

### KOREAN (2)

### PACIFIC ISLAND GROUP (2)

Micronesian, Tagalog, Polynesian, Javanese, Malayan, Sudanese, Indonesian, Hawaiian

### ROMANTIC (1)

French, Italian, Spanish, Portuguese, Latin

### SEMETIC (1)

Arabic, Hebrew

### SINO-TIBETAN and S.E. ASIAN (3)

Burmese, Cantonese, Mandarin, Thai, Tibetan, Vietnamese

### SLAVIC (3)

Bulgarian, Russian, Czech, Polish, Ukrainian, Slovak

level languages and be able to write reasonably complex programs (including video games). Players with a *Programming Skill* +6 or better are considered to be professionals, who can build operating software, design mainframe systems, and hold down a steady job at your average Silicon Valley firm. With a *Programming Skill* of +9 or better, other programmers speak your name with reverence ("You invented Q? Wow!"), young hackers set out to crack your systems, and any computer software you design instantly gets used by every business application in the world.

**Shadow/Track:** The skill of shadowing and following people. This skill is primarily used in urban or inhabited areas rather than in wilderness (where the skill of *Survival* incorporates tracking game in the wilds).

**Stock Market:** The ability to play the stock market, engage in routine stock transactions and manipulate stocks profitably. At +2, you know enough to invest in junk bonds and lose your shirt. At +6, your investments pay off 75% of the time. At +9, you are a major heavy on the Market, routinely dabble in international stocks, and can write learned articles on the subject of investment.

**System Knowledge:** Basic knowledge of the geography of the Net, it's lore and history, as well as knowledge of the important computer systems, their strengths and their weaknesses. At +2, you can generally navigate around the Net and know where all the local places are. At +6, you know the locations of most places in the Net, and have a working understanding of its largest and most well known systems. At +9, you know the entire Net like the back of your hand, know the general layouts of the important systems cold, and are aware of the layouts for the rest of them.

**Teaching:** The skill of imparting knowledge to someone else (if you don't think this is a skill, you ought to try it sometime). Players may not teach any skill unless they have a higher skill level than the student. The referee is the final arbiter of how long it takes to teach a skill. At a *Teaching Skill* of +3 or better, you can professionally teach students up to High School. At +6, you know enough to be a college professor (if you wanted). At +9 or greater, you

are recognized by others in the field as good enough to guest lecture at MIT or Cal Tech; your texts on the subject are quoted as the major references, and you might have a TV show on the equivalent of the PBS channel.

**Wilderness Survival:** The required skill for knowing how to survive in the wilds. Knowledge includes how to set traps, forage for food, track game, build shelters, make fires. The average Boy Scout has a *Survival* of +3. A Special Forces Green Beret has a *Survival* of +6 or above. Grizzly Adams, Mountain Man of the Wilderness, would have a +9 or +10 *Survival Skill*.

***Blackhand popped the submachinegun hidden in his left arm, while bringing the monoblade up in the other hand. There was a spray of blood as the tech katana connected with the ninja's throat...***

**Zoology:** Knowledge of lifeforms, biological processes and their relation to the environment. At +2, you know most common animals. At +5, you know not only well known animals, but also about many exotics and endangered species. At +8, you are knowledgeable on almost all animals, know their habits well, and have a +1 advantage to any *Wilderness Survival Skills* (you know where to find the game).

### Reflex Skills

**Archery:** The skill required to use bows, crossbows and other arrow-based ranged weapons. See *Handgun* for details.

**Athletics:** This skill is required for accurate throwing, climbing, and balancing. It combines the basic elements of any high school level sports program. At +3 and above, you are the equivalent of a real high school "jock". At +5 and above, you can perform in college level competitions. At +8 and above, you are of Olympic or Professional caliber.

**Brawling:** The skill of fighting man to man with fist, feet and other parts of the body. *Brawling* is not a trained skill— it is learned on the Street by getting into a lot of fights. Unlike *Martial Arts*, there are no specialized attacks and no damage bonuses based on level of mastery.

**Dance:** The specific skill needed to become a professional dancer. A trained dancer +4 or greater can successfully dance for payment in small clubs or dance troupes. Dancers +6 or greater will be considered to be of professional caliber, and regularly give performances and have fans. Dancers +9 or greater are of "star" caliber, have a large number of fans, and may be recognized on the street.

**Dodge & Escape:** This skill is required to dodge attacks and escape grapples and holds. If an attack is made without your knowledge, you may not apply this skill to your *Defense* roll.

**Driving:** This skill allows you to pilot all ground vehicles like cars, trucks, tanks and hovercraft. This skill is not useable for piloting aircraft. A skill of +3 is equal to that of a very good non-professional driver. A skill of +6 allows you to drive with the skill of a moderately skilled race driver. An driver with a skill of +8 or greater will be nationally known as a racer, regularly win championship races, and possibly have access to the most advanced ground vehicles available (as long as he makes an endorsement).

**Fencing:** The mastery of swords, rapiers and monoblades. A *Fencing Skill* of +3 allows you to be competent with a blade. A Skill of +5 makes you fairly skilled. A *Fencing Skill* of +6 might win you the National Fencing Competitions. A Skill of +8 will get you a reputation for being a true swordsman of duellist caliber. People like D'Artagnan or Miyamoto Musashi have Skills of +10. They are legendary masters of the blade; the mention of whom will cause all but the stupidest young bravo to run for cover.

**Handgun:** You must have this skill to effectively use handguns of any type, including cyberwear types. At +2, you can use a handgun effectively on a target range, though combat will still rattle you. At +5, you are as skilled as most military officers or policemen. At +7, you can do the sort of fancy shooting you see on TV, and have begun to get a reputation of being "good with a gun". At +8, you are a recognized



gunslinger with a “rep”. The very sound of your name makes some people back down in fear. At +10, you are a legendary gunslinger, feared by all except the stupid young punks who keep trying to “take” you in innumerable gunfight challenges.

**Heavy Weapons:** The required skill for using grenade launchers, autocannon, mortars, heavy machine guns, missiles and rocket launchers. A Level +5 skill would be equivalent to a general military “Heavy Weapons” training course, giving the user the ability to use any or all of these weapon types.

**Martial Arts:** This skill covers any type of trained fighting style using hands, feet, or specialized “martial arts” weapons. You must elect a style of martial art and take a separate skill for each style (for example, you would have to take *Karate* and *Judo* separately, spending points for each one. Difficulty modifiers are listed in ( ) next to each skill listed below.

The primary advantage to martial arts styles is that each one has what are called key attacks; attacks that reflect particular strengths of the style. When a key attack is used, there is a to-hit bonus based on the attack type and martial arts style. A full table of key attacks is listed in *Friday Night Firefight*, pg. 100.

The second advantage to martial arts styles is that there is a damage bonus on attacks equal to the level of the *Martial Arts* skill; for example, a master with a +10 *Kung Fu* Skill would add 10 points to his damage. This can be a formidable advantage, particularly in head strikes (which double damage).

**Martial Arts** forms include:

**Aikido (3):** This form relies on using the opponent’s strength and momentum against him. It is a perfect form for stopping an opponent peacefully while making yourself very hard to hit. Key attacks are: blocks & parries, dodges, throws, holds, escapes, chokes, sweeps, trips & sweeps, grapples.

**Animal Kung Fu (3):** These are forms based on animal movements, such as crane, mantis, tiger, leopard and dragon forms. These attacks are fast and dangerous, with a style that is exciting and flashy. Key attacks include: strikes, punches, kicks, blocks & parries, sweeps & trips.

**Boxing (1):** The manly art of fisticuffs, this form delivers lightning punches and a tight

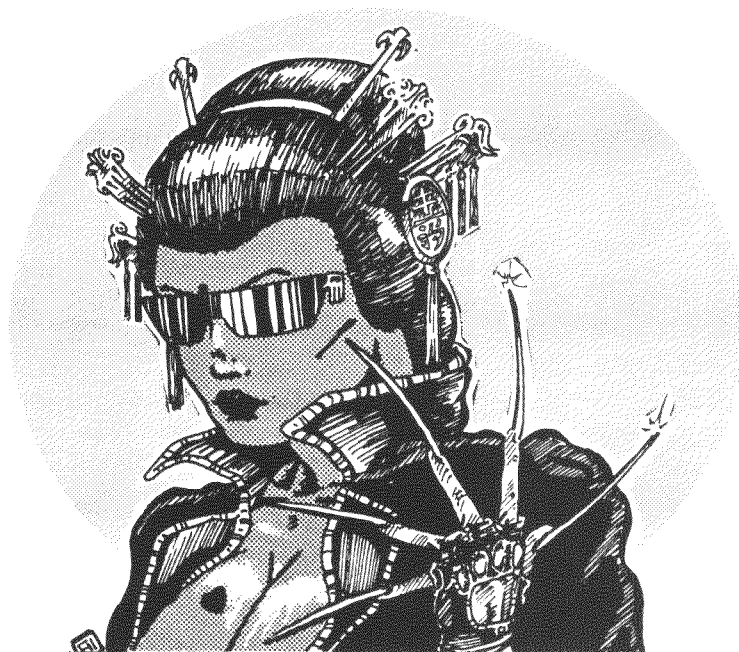

blocking defense. Key attacks are: punches, blocks & parries.

**Capoeria (3):** Created by Carribean slaves, this form combines dancelike movements with fast kicks and low line sweeps. It is a relatively unknown form and can be combined with dance moves to disguise its true power. Key attacks are: punches, kicks, blocks & parries, dodges, and sweeps & trips.

**Choi Li Fut (3):** Descended directly from the ancient Shaolin temples, this form combines powerful roundhouse blows and sweeping kicks into a dynamic fighting style. Key attacks are: strikes, punches, kicks, blocks & parries, dodges, throws, and sweeps & trips.

**Judo (1):** This system was designed as a sport form, but is very effective in combat as well. It uses throws and sweeps to knock down the opponent. Key attacks include: dodges, throws, holds, escapes, sweeps & trips and grappling.

**Karate (2):** The Japanese version of kung fu, this style uses straight line movements and powerful blows. Variations include shotokan and kenpo, each with their own special moves. Key attacks are: punches, kicks, and blocks & parries.

**Tae Kwon Do (3):** A very fast and precise form, with graceful movements and some aerial kicks. Key attacks include: strikes, punches, kicks, block & parries, dodges.

**Thai Kick Boxing (4):** One of the deadliest forms in existence, this style is known for blinding kicks delivered with incredible

power. Key moves include: strikes, punches, kicks, blocks & parries, and grapples.

**Wrestling (1):** This form combines techniques of Olympic and Professional wrestling. The style uses a wide variety of throws and holds to incapacitate the opponent. Key attacks include: throws, holds, escapes, chokes, sweeps, trips, and grapples.

**Melee:** The ability to use knives, axes, clubs and other hand to hand weapons in combat. Note: when using non-ranged cyberweapons such as rippers, scratchers, slice n’ dices, cyberbeasts, and battlegloves, you must use this skill.

**Motorcycle:** The required skill to operate motorcycles, cyberbikes and other two and three-wheeled vehicles.

**Operate Heavy Machinery:** The required skill to operate tractors, tanks, very large trucks and construction equipment.

**Piloting:** In general, this is the skill of controlling aircraft. Aircraft are broken into categories: **Gyro and Rotorcraft**, **Fixed Wing Aircraft**, **Dirigibles** and **Vectored Thrust Aerodynes (AV-s)**. A *Piloting* Skill of +1 allows you to take off and land safely in good weather conditions. A *Piloting* Skill of +3 or more makes you a trained pilot, able to engage in most combat situations or bad weather. Pilots with a Skill of +6 or greater are veteran pilots, able to handle themselves in almost any situation, including aerobatic man-

**"A lot of solos think you don't need any Tech skills. They think that when they need to get a fast fix-up, they'll just put the lean on the nearest Techie and that'll do it.**

**Yeah, sure. The guy who doesn't know how his hardware works is gonna find himself groveling at his Techie's feet when the chips are down. Because you can't intimidate nothin' when your spinal column locks up..."**

**—Morgan Blackhand  
The Enforcer's Handbook**

uevers. Pilots with a Skill of +9 or greater are so good, they have a rep as pilots, and are widely known among the piloting fraternity for having the "right stuff".

**Pilot Gyro (3):** The ability to pilot all types of rotorwing aircraft, including gyros, copters and Ospreys.

**Pilot Fixed Wing(2):** The ability to pilot fixed wing jets and light aircraft. Ospreys may be flown with this skill, but only in the straight ahead (non-hover) mode.

**Pilot Dirigible (2):** The ability to pilot all lighter than air vehicles, including cargo dirigibles, blimps and powered balloons.

**Pilot Vectored Thrust Vehicle (3):** The skill of piloting all types of vectored thrust vehicles, including hovercars, hover rafts and AV-4, 6 and 7 vehicles.

**Rifle:** You must have this skill to use rifles/shotguns effectively (see *Handguns* for limitations and modifiers).

**Stealth (2):** The skill of hiding in shadows, moving silently, evading guards, etc. A *Stealth* Skill of +1 is about the level of a very sneaky 10 year old stealing cookies. At +3, you are able to get past most guards, or your parents if you've been grounded. At +6, you are good enough to slip smoothly from shadow to shadow and not make any noise. At +8, you are the equal of most Ninja warriors. At +10, you move as silently as a shadow, making the Ninja sound like elephants.

**Submachinegun:** You must have this skill to use any type of submachine gun effectively (see *Handguns* for limitations and modifiers).

### Technical Skills

**Aero Tech (2):** The required skill for repairing fixed wing aircraft, including Ospreys, jets, and light aircraft. With a Skill of +3, you can perform most routine maintenance tasks. With a Skill of +6, you can do engine teardowns and major structural repairs. With a Skill of +9 or better, you are capable of designing and building your own aircraft.

**AV Tech (3):** The required skill for repairing all ducted fan aerodyne vehicles. At +3, you can perform routine maintenance. At +6, you can

tear down engines and modify an AV. At +10, you can design your own AVs on common airframes.

**Basic Tech (2):** The required skills for building or repairing simple mechanical and electrical devices, such as car engines, television sets, etc. With a *Basic Tech* Skill of +3 or better, you can fix minor car problems, repair basic wiring, etc. A *Basic Tech* Skill of +6 or better can repair stereos and TVs, rebuild an engine, etc. A *Basic Tech* Skill of +9 or better can build a simple computer from scratch, put together a race car engine, and maintain any kind of industrial machinery. However, they do not know enough specialized knowledge to apply it to complex things such as aircraft (just like Mr. Goodwrench doesn't know how to build and service an F-16).

**Cryotank Operation:** The required skill for operating, repairing and maintaining life suspension and body chilling devices. A minimum skill of +4 is required to chill down a healthy person. A minimum skill of +6 for chilling a wounded person.

**Cyberdeck Design (2):** The required skill for designing cyberdecks. At level +4, you can modify an existing cyberdeck for greater speed or memory. At level +6, you can design a deck equal to most existing designs. At +8, you can design decks that are substantially improved over existing designs.

**CyberTech (2):** The required skill for repairing and maintaining cyberwear. At level +2, you can keep your cyberwear tuned up and can replace its power batteries. At level +6, you can strip down most cyberwear and even make simple modifications. At level +8, you can design your own cyberwear to order.

**Demolitions(2):** This skill allows the character to be knowledgeable in the use of explosives, as well as knowing the best explosives to use for which jobs, how to set timers and detonators, and how much explosive to use to accomplish a desired result.

**Disguise:** The skill of disguising your character to resemble someone else, whether real or fictitious. This skill incorporates elements of both makeup and acting, although it is not the same as the ability to actually be an actor.

**"Panzers, AV's, gyros, dirigibles...I've jacked them all. Gimme a couple of skillchips and a bottle of tequila, and I could steer the frackin' Hindenberg through an outside loop."**  
—Razorjack

**Electronics:** The required skill for maintaining, repairing and modifying electronic instruments such as computers, personal electronics hardware, electronic security systems, cameras and monitors.

**Electronic Security (2):** The skill of installing or countering electronic eyes, electronic locks, bugs and tracers, security cameras, pressure plates, etc. At level +3, you can jimmy or install most apartment locks and security cams. At +6, you can override most corporate office locks and traps. At +9, you can enter most high security areas with impunity.

**First Aid:** This skill allows the user to bind wounds, stop bleeding, and revive a stunned patient (see *Trauma Team*, pg. 116 for details).

**Forgery:** The skill of copying and creating false documents and identifications. This skill may also be applied to the detection of same; if you can fake it, you can usually tell a fake as well.

**Gyro Tech (3):** The skill of repairing and maintaining rotorwing aircraft such as helicopters and gyrocopters.

**Paint or Draw:** The skill of producing professional drawings. A Skill of +3 allows you to produce salable "modern" art. A Skill of +6 will produce artwork that is recognizable and extremely pleasant to the eye—as well as salable. An artist with a Skill of +8 or greater will be nationally known, have exhibits in galleries, and have other lesser artists studying his style in art school.

**Photography & Film:** The skill of producing professional-caliber photographs or motion pictures. A Skill of +2 allows you to make decent home movies. A Skill of +4 or better creates work capable of winning amateur contests. A Skill of +6 or better will produce work of the level of the average Playboy cover or rock video. A photographer or cinematographer with a Skill of +8 or better will be nationally known and probably famous.

**Pharmaceuticals (2):** The skill of designing and manufacturing drugs and medicines. A minimum *Chemistry* skill of +4 is required. At +4, you can make aspirin. At +6, you can make hallucinogenics or antibiotics. At level +9 you can build designer drugs tailored to individual body chemistries.

**Pick Lock:** The skill required to pick locks and break into sealed containers and rooms. At +3, you can jimmy most simple locks. At +6 you can

crack most safes. At +9 or better, you have a rep as a master cracksmen, and are known to all the major players in the *Cyberpunk* world.

**Pick Pocket:** The required skill for picking pockets without being noticed, as well as "shoplifting" small items. For ideas on levels of ability, see *Pick Lock*, above.

**Play Instrument:** The skill of knowing how to play a musical instrument. You must take this skill separately for each type of instrument played. A Skill of +4 or higher will qualify your character to play professional "gigs". A Skill of +8 and above will gain the musician some professional acclaim, possibly with recording contracts and command performances. At +10, you are widely acclaimed, have lots of Grammys, and regularly jam with Kerry Eurodyne.

**Weaponsmith (2):** The required skill for repairing and maintaining weapons of all types. At level +2, you can do repairs and field stripping. At level +6, you can repair all types of weapons and make simple modifications. At level +8, you can design your own weapons to order.

### Learning New Skills and Improving Old Ones

Players can improve their skills or begin new ones by accumulating *Improvement Points* (IP). As you gain more IP, you'll record these points in the area next to the skills listing on your Hardcopy Form. When you have collected enough Improvement Points in a skill, the skill's level increases by one.

The first level of a skill will always cost 10 IP. To determine how many points are required to raise a skill *higher* than this, multiply the current level of skill by 10. This is how many points are required to raise a simple (IP multiplier=1) skill to the next level.

*Example: My Brawling skill is +4. To move from +4 to +5 will require 40 IP. To move from +5 to +6 will require 50 IP.*

### IP Multipliers

Not all skills are equally easy to learn. These skills have an additional **IP multiplier** which multiplies the number of points required to learn the next level of skill. This extra cost will be noted in the skill descriptions.

*"When I was  
downtime—  
between jobs—  
I made a fair  
livin' fixin'  
aerodynes and  
choppers. Glad  
to see my  
military  
training paid  
off somewhere  
besides behind  
a gunsight."  
—Ripperjack*

"Where did I learn? On the Street of Pain, and the Schoolyard of Bad Breaks."

—Unknown Rocker, 2018

*Example: Choi Li Fut has a multiplier of 3. To raise my Choi Li Fut skill from +4 to +5 would require 120 IP, not 40.*

### Getting More IP

There are three ways to accumulate Improvement Points: *Study & Practice*, *Being Taught*, and *Direct Experience*. In all three cases, the amount of improvement is determined by the Referee of your game.

**Study & Practice:** In its simplest form, you get a how-to book and begin practicing. Study is pretty tough—you have no idea of where to begin, and no one to correct your mistakes. The biggest limit to this type of learning is that you can only improve your skill from a level of +0 to a level of +2. In general, it takes about 1 day of book learning to gain 1 IP.

**Being Taught:** Finding a teacher is far superior to self-teaching or book learning. The teacher must have a higher level of skill than the student, and must have the time to teach you (how long this takes, of course, is determined by the Referee). But even the most knowledgeable of teachers may not be able to transfer that knowledge. That's where the skill of *Teaching* comes into play. The teacher must average his skill in the subject to be taught with his teaching skill. He may then teach the student up to that level of skill. How long this takes is, of course, up to the Referee, who awards IP over the passage of time (usually 1-5 IP per lesson).

**Experience:** Still the best teacher. Whenever you do something well, the Referee rewards you with *Improvement Points* right on the spot. The problem is that these points will be applied to the skill you were using when you got the reward. Therefore, if you want to get better in a particular skill, it's important to use that skill every chance you get. Referees should use an even hand when rewarding *Improvement Points*, not only rewarding players for doing things well, but also for demonstrating both role-playing ability and teamwork. In general, we suggest not awarding more than six points per skill per game session.

### IP AWARD GUIDELINE TABLE

Award	Based on:
1	Used Skills in this area often, even if not effectively.
2	Used Skills effectively.
3	Frequent and effective use of Skill.
4	Did something out of the ordinary with this Skill.
5	Very clever or effective use of this Skill.
6	Extremely clever or effective use of Skill.
7	Skill was critical to player in this adventure session.
8	Skill use was critical to entire group this adventure session.
9	Did something really incredible with this Skill.

### Inventing New Skills

You can also invent new skills to cover new needs, should you want to do so. To do so, you must first convince the Referee of your game to let you have that skill. You and the Referee should work together to determine:

- 1) Exactly **what** does this skill allow you to do?
- 2) **How** (according to your character conception) did you acquire this skill?
- 3) What are the specific **limits** of this skill (what can't I do with it?)
- 4) What **stat** is this skill connected to and why?

Referees should be careful to make sure that player skills are neither too specific ("Shoot .45 Caliber Handgun With Laser Sight"), or too general ("Shoot Anything Well"). You should insist on a middle ground which covers a general ability to use the skill, yet does not give the player an unreasonable advantage in all possible situations ("Shoot Handguns"). The Referee is always the final arbiter of decisions on skills.

### Another Kind of Experience: Reputation

*Reputation* is a measure of things your character may do so well (or badly) that he has actually become well known for them. A reputation for something is always es-



tablished by a character's actions, and is then awarded by the Referee. Whenever a character encounters new people in new situations, his reputation may actually influence how they react to him. Sometimes this can be very good. Other times, it can be very bad:

*Example: Jake the Hammer is known far and wide as a streetfighter; he is feared throughout Night City for his trademark killer punch. Over time, the Referee has awarded Jake a Reputation of 6 points. Anyone who meets Jake for the first time must roll higher than 6 on 1D10 in order to have not heard of Jake's name. On this particular night, Jake swaggers into the Totentanz and orders a drink. Down the bar, Ripperjack hears the bartender address Jake by name. Ripperjack puts two and two together (a 3 on 1D10). This "Jake" must be the sonovagun who caught The Jack's kid brother in an alley and beat him to death with his metalshod fists. Ripperjack's eyes flare, and his teeth grind down. He pulls out his Minami 10 and blows a hole through Jake's back.*

**REPUTATION TABLE**

Level	Who Knows About You
1	Anyone who was there at the time knows.
2	Stories have gotten around to immediate friends.
3	All your co-workers and casual acquaintances know.
4	Stories are all over the local area.
5	Your name is recognized by others beyond your local area.
6	You are known on sight by others beyond your local area.
7	A news story or two has been written about your exploits.
8	Your exploits regularly make the headlines and screamsheets.
9	Your exploits always make the screamsheets and TV.
10	You're known worldwide.

Reputation can also be a disadvantage. Whenever you do something extremely uncool (show cowardice, desert or betray someone, etc.), the Referee can still award you Reputation Points for these actions. The more points you score, the more likely people are to have heard about your infa-

mous deeds (once again, roll 1D10). However, this time they won't be impressed. If your rep is for cowardice, it can even work against you.

Reputation in *Cyberpunk* has one other big effect—facedowns. Remember; a lot of combat in this genre comes down to a duel of wills; who's tougher, meaner, and looks more ready to prove it. This often leads to what are called facedowns; when two heavies on the Street square off just before a fight, or to see who'll back down from a confrontation.

When making a facedown, both participants will roll:

**1D10+COOL+ REPUTATION**

**Note:** If one of the opponents has a reputation for cowardice, his value will be treated as a negative number.

In a facedown, the loser has the option of backing down or making any subsequent attacks against this particular opponent at a -3 (due to fear) until he has successfully defeated that opponent once. On a tied roll, both parties are unsure and no penalties will apply.

*Example: The Ironmaster is a feared boosterganger known throughout Night City. In the middle of the Slammer, he runs across an attractive young woman and her male companion. The Ironmaster says "Take a clue and vanish, Kid-trash; the input's with me now." The Kid stands up and says, "Vanish yourself, burnbrain." A faceoff begins.*

*The Ironmaster is known all over the City, giving him a Rep of 6. What he doesn't know is that the Kid is a 5th Dan black belt in Kenpo Karate. Although he's new in the Zone and hasn't much of a Rep (3), he is totally self-possessed and aware of his skills (COOL=10). The Ironmaster may be tough, but he's mostly a bully. His COOL is only 4, bolstered by a Reputation made on a few lucky fights. His total roll is 4+4+(roll of 6)=14. The Kid's total is 3+10+(roll of 3)=16. The Ironmaster feels a strange unease as he stares at the calm, ready-to-rock Kid. His eyes shift away and he backs down with a grunt.*

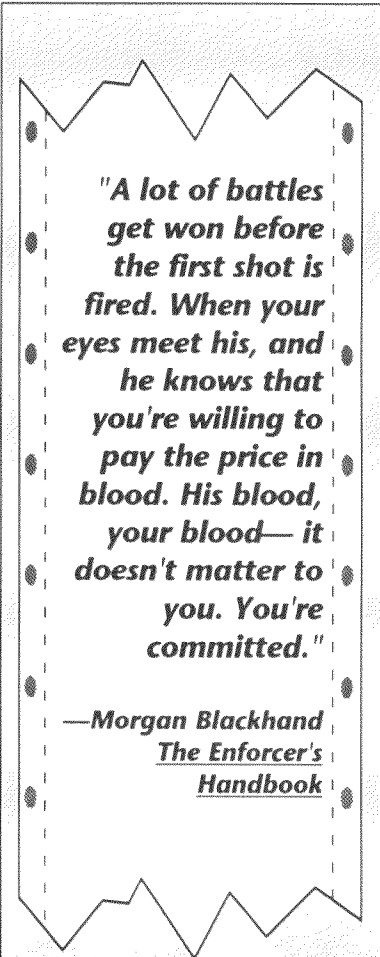

**"A lot of battles get won before the first shot is fired. When your eyes meet his, and he knows that you're willing to pay the price in blood. His blood, your blood—it doesn't matter to you. You're committed."**

—Morgan Blackhand  
*The Enforcer's Handbook*

**ROLES**  
**CHARACTERS**  
**LIFEPATH**  
**TASK & SKILLS**  
**WEAPONS**  
**ARMOR**  
**GEAR**  
**CYBERWEAR**  
**COMBAT**  
**MEDICAL**  
**NETRUNNING**

*"Start with the hardware. In my case, it's an Arasaka. Always use 'em. Dependable. I like to stack a little Kevlar on my back to cover my bets, with a good helmet on top. Then I get down to the basics. Extra ammo—usually armor piercing. A couple knives, including a good monoblade. Some grenades, just in case...you never know what parking problems you'll encounter..."*

—Lt. "Red" Napalm  
NCPD Psycho Squad



## SECTION

# 5 GETTING FITTED FOR THE FUTURE

## The Outfit

The *Cyberpunk* future is mobile. Like the cowboys of the Old West, most people carry their lives on their backs—miniaturized sleeping, eating and entertainment components crammed into carryalls and the back seats of cars. The stuff you carry around is known in streetslang as your *outfit*. A typical outfit might include:

- Inflatable bed (folds to a 6"x6" package for easy storage).
- Compressible down sleep-bag (wads to the size of a paperback book).
- Micro-stereo compo (a micro-sized boom box with stereo speakers or headphones, possibly CD, chip/tape player, TV and certainly radio).
- Handful of tapes or datachips.
- Laptop or pocket computer (for notes, writing, business, links to computer networks).
- Cybermodem, cables (for Netrunners).
- Pocket Cellular phone (the phone is bought, the service is rented by the month).
- Handgun, knife or both. Possibly an assault rifle or SMG, and a couple backups as well. Always extra ammo.
- Body armor (usually an armor jacket or bullet-proof T-shirt).
- Personal things, like clothes, toothbrushes, etc.

Most of this is crammed into a shoulderbag or duffle sack. Most *Cyberpunk* characters aren't much for settling down. Rockerboys always have the next gig. Solos have to keep moving—the next job requires it, and you keep moving anyway before your enemies figure out where you're sleeping these days. Cops, Netrunners, Medias and Techies are always on the move—on stake-outs, hard stories, or running from the various people you've brought down on yourself with your netrunning. Nomads—well, they don't have homes to start with, and what good is it if you can't cram it on the back of your bike anyway? Even a Corporate may find himself living out of a "coffin" in the Tokyo airport if times get rough.

The point is, a computer society makes it easy for people to live like campers all the time. Why should you have to go home to listen to your favorite music when you can

### MONEY IN 2020

For years, everyone in the late 20th century *thought* the currency of the future would be the Japanese *yen*. But only one country uses the yen on a regular basis, whereas a lot of countries use the dollar interchangeably with their own.

The modern Eurodollar is based in part on the U.S. Dollar's universal appeal. At the start of the 1992 Treaty that established the European Economic Community, the EEC created the EURO-DOLLAR (eb), based on an average of U.S., French, German, British and Japanese currencies. At first this sounded great; the Eurodollar was pegged to a strong currency and everyone assumed the U.S. would remain relatively stable.

They wuz wrong.

Eurodollars are pretty much the standard of currency in the 2020 world; accepted in the U.S., Japan, the Far East and what's left of the Middle East.

The catch is that, thanks to the Collapse and the Deficit, the *current* U.S. dollar is usually worth less than its relatives. So on a one-to-one currency exchange rate, this means you get about one Eurodollar for every two American dollars.

**Your  
OUTFIT—  
your worldly  
possessions  
stuffed in a  
2x4  
carry bag**

carry your CD player with you? Missing phone calls and hate answering machines? You carry your phone with you and plug into the cellular network; making your business calls on the run from your favorite restaurant or while driving your car. Why bother with cooking when you can grab something quick from a hundred fast food stores? Why keep clothes when you can use them till they wear out, then buy new ones? You'll rent a sleeping cube for the night, put up your personal stuff, and blow out in the morning. Remember:

### THE FUTURE IS DISPOSABLE

The key to any *Cyberpunk* game is thinking *Cyberpunk*. Think rootless and mobile. You don't know where you're sleeping tonight, and you don't care. You've got a bed in

your bag, some tunes in your pocket, some cash for food. And a gun to make sure no one takes anything away from you.

### Starting Funds

So how much do you start with? Well, that depends on your job.

A job? Yeah, even in the Dark Future, ya gotta pay the bills, chombatta. And you *want* a job, because it's a real short slip between being able to eat Realpack and fresh veggies, and being reduced to eating kibble and living in a filthy flop-cube.

How good a job you currently have is based on the level of your Special Ability. For example, a Rocker with a *Charismatic Leadership* of 2 isn't gonna draw crowds like Kerry Eurodyne (a hot megarocker). This means he'll be reduced to playing gigs wherever

**"Yeah, the future is disposable. So are you, homeboy"**  
—Razorjack

## OCCUPATION TABLE

ROLE	Special Ability Level					
	1-5	6	7	8	9	10
<b>Rocker</b>	Desperate for gigs 1,000 month	Regular Club Jobs 1,500 month	Play the Big Clubs 2,000 month	You've got a Contract 5,000 month	Concert Band 8,000 month	Major Act 12,000 month
<b>Solo</b>	Street Ronin 2,000 month	Private Enforcer 3,000 month	Corporate Muscle 4,500 month	Professional Operative 7,000 month	Major League Hitter 9,000 month	Solo Elite 12,000 month
<b>Cop</b>	Private Guard 1,000 month	City Cop 1,200 month	Corporate Guard/Detective 3,000 month	Corp. Security/Psycho Squad 5,000 month	Enforcement Team Leader 7,000 month	Security Head/Police Chief 9,000 month
<b>Corporate</b>	Assistant 1,500 month	Manager 3,000 month	Junior Executive 5,000 month	Executive 7,000 month	Department Head 9,000 month	Division Head 12,000 month
<b>Media</b>	Stringer Reporter 1,000 month	Staff Reporter 1,200 month	Section Editor 3,000 month	Producer/Managing Editor 5,000 month	Local Media Personality 7,000 month	National Media Personality 10,000 month
<b>Fixer</b>	Street Punk 1,500 month	Gang Leader 3,000 month	Enforcer 5,000 month	Sub-Lieutenant 7,000 month	Lieutenant 8,000 month	Crime Boss 10,000 month
<b>Techie</b>	Local Fixit Man 1,000 month	Private Operator 2,000 month	Corporate Tech 3,000 month	Jr. Engineer 4,000 month	Engineer 5,000 month	Senior Engineer 8,000 month
<b>Netrunner</b>	Weefle Runner 1,000 month	Hacker 2,000 month	Bit Jockey 3,000 month	Net Cowboy 5,000 month	Deckslinger 7,000 month	Sysop 10,000 month
<b>Medtechie</b>	Patchman 1,600 month	Medical Technician 3,000 month	RipperDoc 5,000 month	Trauma Team Medic 7,000 month	General Practitioner 10,000 month	Specialist Physician 15,000 month
<b>Nomad</b>	Clanmember 1,000 month	Warrior 1,500 month	Head of Household 2,000 month	Scout 3,000 month	Clan Senior 4,000 month	Family Head 5,000 month



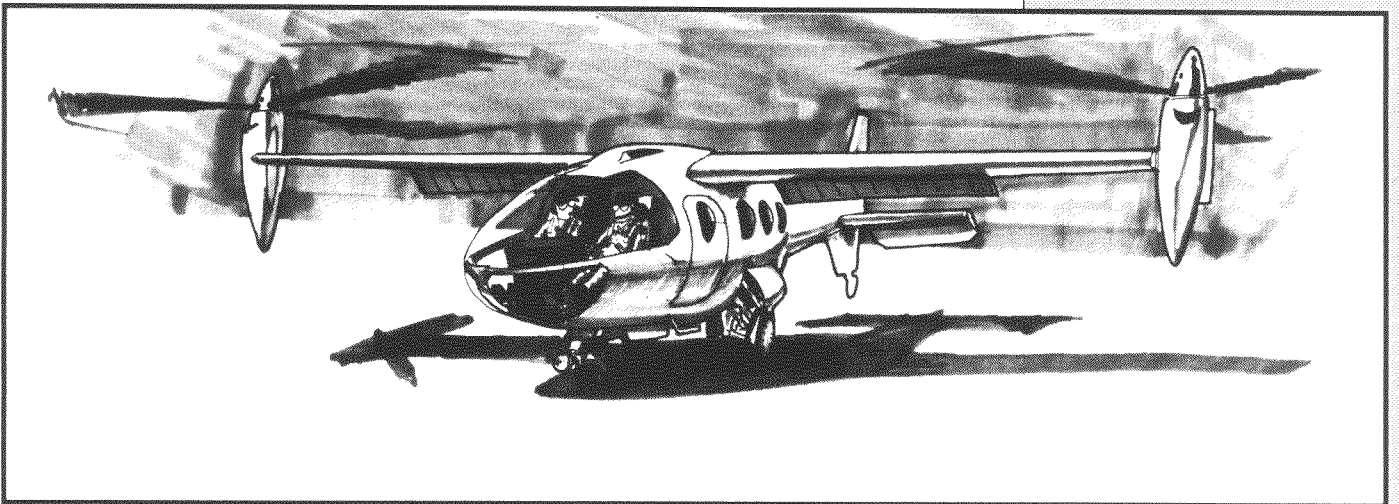

he can get them; sleazoid dives, bar-mitzvahs, weddings, bar fights; you name it.

Take a quick jump to the *Occupation Table* on page 58. Find your Role (or the role closest to it), cross reference it to your current *Special Ability* level, and that'll give you a monthly salary. **Multiply this amount by a 1D6/3 to determine the number of months you've currently been employed, and that gives you the total amount of cash your character starts with.**

Exactly how you earn your euro is up to you; the categories are deliberately vague to give you plenty of roleplaying room. Maybe as "Level 7" Solo, you don't want to work for a Corporation; no problem. It's only a general description of where you fit on the Solo hierarchy. For all we know, you work on an extraction team for *Amnesty International*.

One last thing. Roll one more D6. If you roll higher than a four, you just got unemployed.

Congratulations. Betcha can taste that kibble already.

### Encumbrance

In most cases, encumbrance isn't a big problem for a *Cyberpunk* character—he's going to keep the majority of his gear in his apartment or his car. A *Cyberpunk* character can carry around as much in kilograms as the number of points invested in his *Body Type* stat, multiplied by 10. He can deadlift 40 times his *Body Type* stat.

*Example: I have spent 6 points to get an Average Body Type. I can carry up to 60 kilograms; roughly 132 lbs. I can deadlift 240 kg—about 528 lbs.*

Rather than list exact weights of everything you could possibly want to carry, we have arranged a simpler system of classification. The following weight groups are more useful to the Referee who must make a general determination of how much a player can carry.

#### 0.5 kilos or less

1 box of ammo • cellular phone • personal stereo • pocket computer • cybermodem • interface cables • pocket TV • Digital camera • Small recorder • flashlight • binoculars • Swiss Army knife • article of clothing • fighting knife • switchblade • mirror-shades • Light pistol • nylon carrybag • Kevlar helmet.

#### 1 Kilo or less

Medium to Heavy handgun • sleeping bag • radio/chip player • video camera • toolkit • medical kit • laptop computer • armor vest/T-shirt.

#### 3 Kilos

Submachine gun • Very Heavy Pistol • electric guitar • drum synthesizer • inflatable bed • Light to Medium assault rifle • Shotgun • Armor jacket • Kevlar flack pants or vest.

#### 4 Kilos

Electric keyboard • amplifier • Heavy assault rifle.

**"The only difference between most people and us Nomads is that Nomads have better cars..."**

—Nomad Santiago

*"I see guys walking around all the time with big assault rifles slung over their armored shoulders. Dumb. That's like putting on a neon holosign that says, "Hey, I'm a solo—shoot me."*

—Morgan Blackhand

## WEAPONS

The first thing your cyberpunk is gonna want is some weapons (weapons can get you out of a bad situation a lot faster than a great stereo). *Cyberpunk* weapons break into seven types:

**Pistols (P)** are any type of single shot (or semiautomatic) weapon which may be accurately fired with one hand.

**Submachineguns (SMG)** are any type of weapon which may fire either automatically or semi automatically, using only pistol ammunition.

**Shotguns (SHG)** are any weapon which fires pellets or other small particles instead of a solid slug.

**Rifles (RIF)** include assault rifles, carbines, and fully automatic rifles. These weapons always fire rifle type ammunition.

**Heavy Weapons (HVY)** include missiles, grenades, heavy cannon, etc.

**Melee Weapons (MELEE)** include swords, daggers, knives, martial arts weapons, polearms, etc.

**Exotic Weapons (EX)**; these are bows, lasers, flechette pistols, airguns and microwave weapons—the real "sci-fi" weapons of the *Cyberpunk* universe.

### Weapon Codes

Each weapon is represented by certain characteristics, such as its type, damage, range, accuracy, concealability, availability and cost. These factors are recorded as a weapon code—a profile of the weapon in order of:

**Name • Type • Accuracy •  
Concealability  
Availability • Damage/Ammunition •  
Number of Shots • Rate of Fire •  
Reliability**

For an example, a weapon with the code:  
**Minami 10 • SMG • 0 • J • E • 2D6+3/  
10mm • 40 • 20 • VR** would be an Accurate (1) Minami 10 Submachinegun (SMG) which can be hidden under a jacket (J), with excellent availability (E), fires 10mm ammunition, has a 40 shot clip, can fire up to 20

rounds per combat round on full auto, and is very reliable. Descriptions of Weapon Codes follow:

**Accuracy:** This is how good the weapon really is. Weapons are rated from -3 to +3 on accuracy, with 0 being an average level of accuracy.

**Concealability:** How easily they can be hidden until needed (an important factor in combat weapons). A smart combat gunner doesn't want to walk into a bar with a shotgun protruding from underneath his coat—it's going to cause trouble. He also needs to be able to carry "holdouts" in the event of capture or disarmament.

Pocket, Pants Leg or Sleeve ..... (P)  
Jacket, Coat or Shoulder Rig ..... (J)  
Long Coat ..... (L)  
Can't be Hidden ..... (N)

**Availability:** This is how difficult the weapon is to find on the open market.

**Excellent** ..... (E)  
Can be found almost anywhere.

**Common** ..... (C)  
Can be found in most sports & gun stores or on the Street.

**Poor** ..... (P)  
Specialty weapons, black market, stolen military.

**Rare** ..... (R)  
Stolen, one of a kind, special military issue, may be highly illegal.

**Damage/Ammunition:** Each weapon is rated as to the type of ammunition it carries, and the damage of that ammunition (in numbers of dice thrown).

**Number of Shots:** This is how many shots are held in the standard clip, magazine or quiver for the weapon type.

**Rate of Fire:** This is how many shots the weapon can fire in a single combat round (3.2 seconds).

**Reliability:** This is how reliable the weapon is in combat—its chance of jamming while on autofire, etc.

Very Reliable ..... (VR)  
Standard ..... (ST)  
Unreliable ..... (UR)

### WEAPONS LIST

Name	Type	WA	Con.	Avail.	Damage/Ammo	#Shots	ROF	Rel.	Range	Cost
<b>LIGHT AUTOPISTOLS</b>										
BudgetArms C-13	P	-1	P	E	1D6(5mm)	8	2	ST	50m	75. <sup>00</sup>
Dai Lung Cybermag 15	P	-1	P	C	1D6+1(6mm)	10	2	UR	50m	50. <sup>00</sup>
Federated Arms X-22	P	0	P	E	1D6+1(6mm)	10	2	ST	50m	150. <sup>00</sup>
<b>MEDIUM AUTOPISTOLS</b>										
Militech Arms Avenger	P	0	J	E	2D6+1(9mm)	10	2	VR	50m	250. <sup>00</sup>
Dai Lung Streetmaster	P	0	J	E	2D6+3(10mm)	12	2	UR	50m	250. <sup>00</sup>
Federated Arms X-9mm	P	0	J	E	2D6+1(9mm)	12	2	ST	50m	300. <sup>00</sup>
<b>HEAVY AUTOPISTOLS</b>										
BudgetArms Auto 3	P	-1	J	E	3D6(11mm)	8	2	UR	50m	350. <sup>00</sup>
Sternmeyer Type 35	P	0	J	C	3D6(11mm)	8	2	VR	50m	400. <sup>00</sup>
<b>VERY HEAVY AUTOPISTOLS</b>										
Armалite 44	P	0	J	E	4D6+1(12mm)	8	1	ST	50m	450. <sup>00</sup>
Colt AMT Model 2000	P	0	J	C	4D6+1(12mm)	8	1	VR	50m	500. <sup>00</sup>
<b>LIGHT SUBMACHINEGUNS</b>										
Uzi Miniauto 9	SMG	+1	J	E	2D6+1(9mm)	30	35	VR	150m	475. <sup>00</sup>
H&K MP-2013	SMG	+1	J	C	2D6+3(10mm)	35	32	ST	150m	450. <sup>00</sup>
Fed. Arms Tech Assault II	SMG	+1	J	C	1D6+1(6mm)	50	25	ST	150m	400. <sup>00</sup>
<b>MEDIUM SUBMACHINEGUNS</b>										
Arasaka Minami 10	SMG	0	J	E	2D6+3(10mm)	40	20	VR	200m	500. <sup>00</sup>
H&K MPK-9	SMG	+1	J	C	2D6+1(9mm)	35	25	ST	200m	520. <sup>00</sup>
<b>HEAVY SUBMACHINEGUNS</b>										
Sternmeyer SMG 21	SMG	-1	L	E	3D6(11mm)	30	15	VR	200m	500. <sup>00</sup>
H&K MPK-11	SMG	0	L	C	4D6+1(12mm)	30	20	ST	200m	700. <sup>00</sup>
Ingram MAC 14	SMG	-2	L	E	4D6+1(12mm)	20	10	ST	200m	650. <sup>00</sup>
<b>ASSAULT RIFLES</b>										
Militech Ronin Light Assault	RIF	+1	N	C	5D6(5.56)	35	30	VR	400m	450. <sup>00</sup>
AKR-20 Medium Assault	RIF	0	N	C	5D6(5.56)	30	30	ST	400m	500. <sup>00</sup>
FN-RAL Heavy Assault Rifle	RIF	-1	N	C	6D6+2(7.62)	30	30	VR	400m	600. <sup>00</sup>
Kalishnikov A-80 Hvy. Rifle	RIF	-1	N	E	6D6+2(7.62)	35	25	ST	400m	550. <sup>00</sup>
<b>SHOTGUNS</b>										
Arasaka Rapid Assault 12	SHT	-1	N	C	4D6(00)	20	10	ST	50m	900. <sup>00</sup>
Sternmeyer Stakeout 10	SHT	-2	N	R	4D6(00)	10	2	ST	50m	450. <sup>00</sup>
<b>HEAVY WEAPONS</b>										
Barrett-Arasaka Light 20mm	HVY	0	N	R	4D10AP(20/9mm)	10	1	VR	450m	2,000. <sup>00</sup>
Scorpion 16 Missile Launcher	HVY	-1	N	R	7D10	1	1	VR	1km	3,000. <sup>00</sup>
Militech Arms RPG-A	HVY	-2	N	R	6D10	1	1	VR	750m	1,500. <sup>00</sup>
Grenade	HVY	0	P	P	Varies by type	1	1	VR	Throw	30. <sup>00</sup>
C-6 Plastic Explosive	HVY	0	P	P	8D10 per kg.	1	1	VR	NA	100. <sup>00</sup> /kg
Mine (all types)	HVY	0	J	P	4D10	1	1	VR	NA	350. <sup>00</sup>
K-A F-253 Flamethrower	HVY	-2	N	R	2D10+	10	1	ST	50m	1,500. <sup>00</sup>

#### KEY

WA=Weapon Accuracy. Concealability: P=Pocket j=Jacket L=Long Coat N=Can't be hidden. Availability: E=Excellent (can be found anywhere) C=Common (sports & gun shops) P=Poor (stolen military, black market) R=Rare (one of a kind, special military issue, highly illegal). Damage/Ammo: most 2000's weapons are rated in millimeters. # Shots (in a standard clip or load) ROF=Rate of Fire per turn. Range=Long range.

Name	Type	WA	Con.	Avail.	Damage/Ammo	#Shots	ROF	Rel.	Range	Cost
<b>EXOTICS</b>										
Techtronica 15 Microwaver	P	0	J	P	1D6†	10	2	VR	20m	400.00
Militech Elect. LaserCannon	RIF	0	N	R	1-5D6	10	2	UR	200m	8,000.00
Avante P-1135 Needlegun	P	0	P	P	Drugs	15	2	ST	40m	200.00
Enertex AKM Power Squirt	P	-2	J	C	Drugs	50	1	VR	10m	15.00
Nelspot "Wombat"	P	-1	J	C	Drugs	20	2	UR	40m	200.00
Militech Electronics Taser	P	-1	J	C	Stun	10	1	ST	10m	60.00
EagleTech "Tomcat" C- Bow	EX	0	N	C	4D6	12	1	VR	150m	150.00
EagleTech "Stryker" X-bow	EX	-1	N	C	3D6+3	12	1	VR	50m	220.00

### MELEE WEAPONS

Note: Most melee weapons are available on the open market and have a ROF of 1, a WA of 0, and no reloads.

Kendachi Monoknife®	Melee	+1	P	P	2D6	-	-	VR	1m	200.00
Kendachi MonoKatana®	Melee	+1	N	R	4D6	-	-	VR	1m	600.00
SPM-1 Battleglove™	Melee	-2	N	P	3D6/2D6	-	-	VR	1m	900.00

†See pg.98 for microwave damage.

## WEAPON DESCRIPTIONS

**Note: All 2020 weapons are caseless ammunition, composite carbon fiber designs.**

WEAPON CODE= Type • Weapon Accuracy • Concealability • Availability • Damage/Ammo • #Shots • ROF • Reliability

### Light Autopistols

#### BudgetArms C-13

P -1 P E 1D6(5mm) 8 2 ST  
A light duty autopistol used as a hold-out and "lady's gun".

#### Dai Lung Cybermag 15

P -1 P C 1D6+1(6mm) 10 2 UR  
Cheap Hong Kong knockoff, often used by boosters and other street trash.

#### Federated Arms X-22

P 0 J E 1D6+1(6mm) 10 2 ST  
The ubiquitous "Polymer-one-shot" cheap plastic pistol. Available in designer colors.

### Medium Autopistols

#### Militech Arms Avenger

P 0 J E 2D6+1(9mm) 10 2 VR  
A well-made autopistol with good range and accuracy. A professional's gun.

#### Dai Lung Streetmaster

P 0 J E 2D6+3(10mm) 12 2 UR  
Another Dai Lung cheapie, built for the Street.

#### Federated Arms X-9mm

P 0 J E 2D6+1(9mm) 12 2 ST  
A sturdy Solo's gun, used as a standard military sidearm in the U.S. and E.C.C.

### Heavy Autopistols

#### BudgetArms Auto 3

P -1 J E 3D6(11mm) 8 2 UR  
It's cheap. It's powerful. It blows up sometimes. What else do you want?

#### Sternmeyer Type 35

P 0 J C 3D6(11mm) 8 2 VR  
Rugged, reliable, with excellent stopping power. Another fine E.C.C. product from the United Germanies.

### Very Heavy Autopistols

#### Armalite 44

P 0 J E 4D6+1(12mm) 8 1 ST  
Designed as an alternate to the 1998 U.S. Army sidearm trials. A solid contender.

#### Colt AMT Model 2000

P 0 J C 4D6+1(12mm) 8 1 VR  
Now the standard officer's sidearm for the U.S. Army, the M-2000 served well in the Central American Wars.

### Light Submachineguns

#### Uzi Miniauto 9

SMG +1 J E 2D6+1(9mm) 30 35 VR  
Uzi's entry into the 21st century, all plastic, with a rotary electric clip and adjustable trigger. The choice for many security Solos.

#### H&K MP-2013

SMG +1 J C 2D6+3(10mm) 35 32 ST  
Heckler & Koch's updating of the MP-5K classic, with compound plastics and built in silencing.

#### Federated Arms Tech Assault II

SMG +1 J C 1D6+1(6mm) 50 25 ST  
An updated version of the venerable Tech Assault I, features larger clip, better autofire, no melting. Honest.

### Medium Submachineguns

#### Arasaka Minami 10

SMG 0 J E 2D6+3(10mm) 40 20 VR  
The standard Arasaka Security weapon,, found worldwide. A good, allround weapon.

#### H&K MPK-9

SMG +1 J C 2D6+1(9mm) 35 25 ST  
A light composite submachinegun with integral sights. Used by many Euro Solos.

### Heavy Submachineguns

#### Sternmeyer SMG 21

SMG -1 L E 3D6(11mm) 30 15 VR  
Sternmeyer's best entry in the anti-terrorist category, with wide use on C-SWAT teams and PsychoSquads.

#### H&K MPK-11

SMG 0 L C 4D6+1(12mm) 30 20 ST

Possibly the most used Solo's gun in existence, the MPK-11 can be modified into four different designs, including a bullpup configuration, standard SMG, an assault carbine, and a grenade launcher mount.

#### Ingram MAC 14

SMG -2 L E 4D6+1(12mm) 20 10 ST  
Updated MAC-10, with composite body and cylindrical feeding magazine.

### Assault Rifles

#### Militech Ronin Light Assault

RIF +1 N C 5D6(5.56) 35 30 VR  
A light, all purpose update, similar to the M-16B.

#### AKR-20 Medium Assault

RIF 0 N C 5D6(5.56) 30 30 ST  
A plastic and carbon fiber update of the AKM, distributed throughout the remains of the Soviet Bloc.

#### FN-RAL Heavy Assault Rifle

RIF -1 N C 6D6+2(7.62) 30 30 VR  
The standard NATO assault weapon for battlefield work. Bullpup design, collapsing stock.

#### Kalishnikov A-80 Hvy. Assault Rifle

RIF -1 N E 6D6+2(7.62) 35 25 ST  
Another Soviet retreat, with improved sighting and lightened with composites.

### Shotguns

#### Arasaka Rapid Assault Shot 12

SHT -1 N C 4D6 (00) 20 10 ST  
A high powered auto-shotgun with lethal firepower. Used by Arasaka worldwide. Another good reason to avoid the Boys in Black.

#### Stermeyer Stakeout 10

SHT -2 N R 4D6 (00) 10 2 ST  
Light duty stakeout shotgun, used by city police departments.

### Heavy Weapons

#### Barrett-Arasaka Light 20mm

HVY 0 N R 4D10(20/9mm) 10 1 VR  
The cyberpsycho hunter's favorite. Almost 2 meters long, this "cannon" fires a depleted uranium shell at super-

sonic speeds. Heavy AP sub-caliber penetrator damages armor 2pts/hit.

#### Scorpion 16 Missile Launcher

HVY -1 N R 7D10 1 1 VR  
The third generation of the Stinger missile launcher, this shoulder arm fires one missile.

#### Militech Rocket-Grenade Launcher

HVY -2 N R 6D10 1 1 VR  
Shoulder-mounted, rocket-powered grenade launcher. Heavily used in the Central American conflicts under the name *RPG-A*.

#### Grenade

HVY 0 P P Varies 1 1 VR  
Types include Fragmentation (7D6), Incendiary (4D6 for 3 turns), Stun (-5 to Stun), Dazzle (Blind for 4 turns), Sonic (deafened 4 turns), Gas (see FNFF *Gas Table*).

#### Grenade Launchers

HVY 0 L/N R Varies 1 1 ST  
Launcher may be attached (under barrel) to any assault rifle, or handheld. Range 225m, Cost 150eb. Not compatible with Militech RPG-A.

#### C-6 "Flatfire" Plastic Explosive

HVY 0 P P 8D10 per kg. 1 1 VR  
Grey block of plastique, can be detonated by timer, tripwire or signal.

#### Mine (all types)

HVY 0 J P 4D10 1 1 VR  
Can be detonated by timer, tripwire, signal or motion detector.

#### Kenshira Adachi F-253 Flamethrower

HVY -2 N R 2D10 10 1 ST  
Liquified napalm sprayer. Back mounted and bulky. Does extra damage following initial hit (see FNFF, pg.110).

### Exotics

#### Techtronica 15 Microwaver

P 0 J P 1D6 10 2 VR  
Flashlight sized microwave projector. See FNFF, pg. 108 for details.

#### Militech Electronics Laser Cannon

RIF 0 N R 1-5D6 10 2 UR  
Milspec laser cannon, rarely seen. See FNFF, pg. 108 for details.

#### Avante P-1135 Needlegun

P 0 P P Drugs 15 2 ST  
Lightweight, plastic, compressed air powered. Can be doped with drugs, poison. See FNFF, pg. 107 for details.

#### Enertex AKM Power Squirt

P -2 J C Drugs 50 1 VR  
A squirtgun. Yes, a powered squirtgun. See FNFF, pg. 108 before you laugh.

#### Nelspot "Wombat" Airpistol

P -1 J C Drugs 20 2 UR  
Paintball gun from hell. Can fire acid, paint, drugs, poison. See FNFF, pg.107.

#### Militech Electronics Taser

P -1 J C Stun 10 1 ST  
Zap. About the size of a small hand flashlight. See FNFF, pg.107 for details.

#### EagleTech "Tomcat" Compound Bow

EX 0 N C 4D6 12 1 VR  
Gyrobalanced, stabilized compound bow. Silent & deadly.

#### EagleTech "Stryker" Crossbow

EX -1 N C 3D6+3 12 1 VR  
Plastic and bimetal crossbow. Silent, deadly, and you usually get your ammo back.

### Melee Weapons

#### Kendachi Monoknife®

MELEE +1 P P 2D6 NA 1 VR  
Mono-sectional crystal blade. Incredibly sharp. In the Japanese "tanto" style. Also available in a naginata form for 100.<sup>00</sup> extra.

#### Kendachi MonoKatana®

MELEE +1 N R 4D6 NA 1 VR  
Sword length version of monoblade. Resembles a hightech katana with a milky, nearly transparent blade.

#### SPM-1 Battleglove

MELEE -2 N P 3D6/2D6 NA 1 VR  
This is a large gauntlet covering the hand and forearm. It does 3D6 in crush damage, 2D6 punch damage, and has three spaces which can be used to store any standard cyberarm option.



### MELEE WEAPONS

Name	Type	WA	Con.	Avail.	Damage	#Shots	ROF	Rel.	Range	Cost
Club	Melee	0	L	C	1D6	NA	NA	NA	1m	Free
Knife	Melee	0	P	C	1D6	NA	NA	NA	1m	1-20 <sup>00</sup>
Sword	Melee	0	N	C	2D6+2	NA	NA	NA	1m	20-200 <sup>00</sup>
Axe	Melee	-1	N	C	2D6+3	NA	NA	NA	1m	20 <sup>00</sup>
Nunchaku/Tonfa	Melee	0	L	C	3D6	NA	NA	NA	1m	15 <sup>00</sup>
Naginata	Melee	0	N	P	3D6	NA	NA	NA	2m	100 <sup>00</sup>
Shiriken	Melee	0	P	C	1D6/3	NA	NA	NA	Throw	2-3 <sup>00</sup>
Switchblade	Melee	0	P	C	1D6/2	NA	NA	NA	1m	15 <sup>00</sup>
Brass knuckles	Melee	0	P	C	1D6+2	NA	NA	NA	1m	10 <sup>00</sup>
Sledgehammer	Melee	-1	N	C	4D6	NA	NA	NA	1m	20 <sup>00</sup>
Chainsaw	Melee	-3	N	C	4D6	NA	NA	NA	2m	80 <sup>00</sup>

### Kendachi MonoKatana®

MELEE•+1•N•R•4D6•  
NA•I•VR



### RELOADS & OPTIONS

Ammunition†	Cost
Light Pistol, Lt. SMG (box of 100)†	15 <sup>00</sup>
Medium Autopistol, SMG (box of 50)	15 <sup>00</sup>
Heavy Pistol, Hvy. SMG (box of 50)	18 <sup>00</sup>
Very Heavy Pistol (box of 50)	20 <sup>00</sup>
Assault Rifle (box 100)	40 <sup>00</sup>
Shotgun (box of 12)	15 <sup>00</sup>
20mm Cannon round (1)	25 <sup>00</sup>
Arrows (12)	24 <sup>00</sup>
Crossbow Bolts (12)	30 <sup>00</sup>
Airgun pellets (100)*	6 <sup>00</sup>
Needlegun rounds (50)	25 <sup>00</sup>
Flamethrower Reload	50 <sup>00</sup>
Micro Missile Reload (4ea)	100 <sup>00</sup>

#### Options

Silencer	100 <sup>00</sup>
Holster (all types)	20 <sup>00</sup>
Shoulder sling	5 <sup>00</sup>

†Armor piercing=3x cost Brass Cased loads for old guns=2xcost \*Drugs, Acid =5x cost

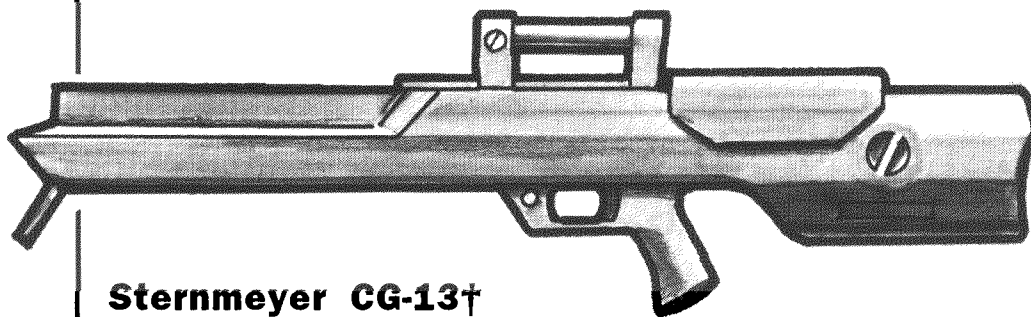

### Sternmeyer CG-13†

RIF•1•N•P•5.56 (5D6)•90•48•VR (700eb)

†From SOLO OF FORTUNE, pg. 38-41

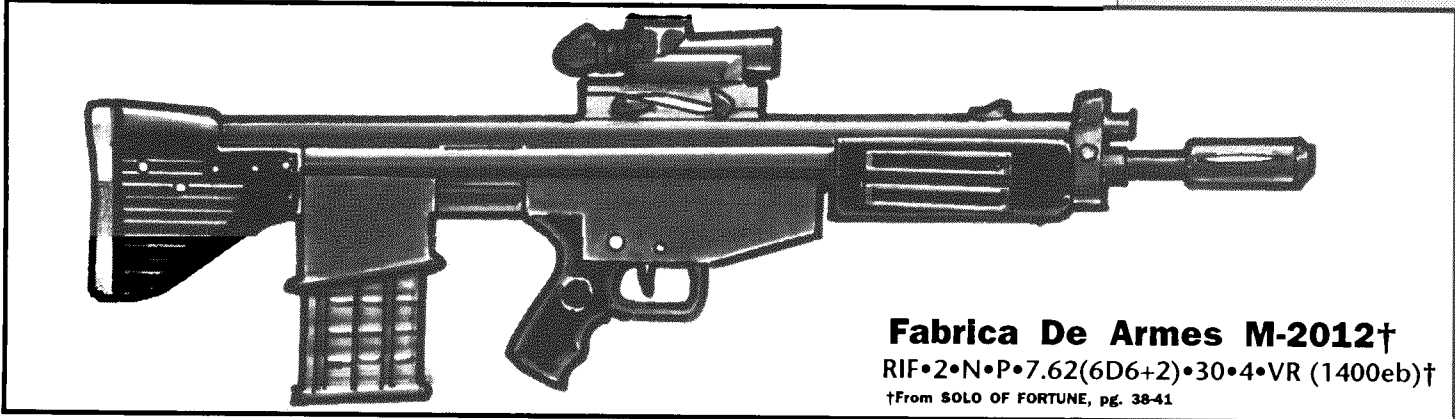

**Fabrica De Armes M-2012†**  
 RIF•2•N•P•7.62(6D6+2)•30•4•VR (1400eb)†  
 †From SOLO OF FORTUNE, pg. 38-41

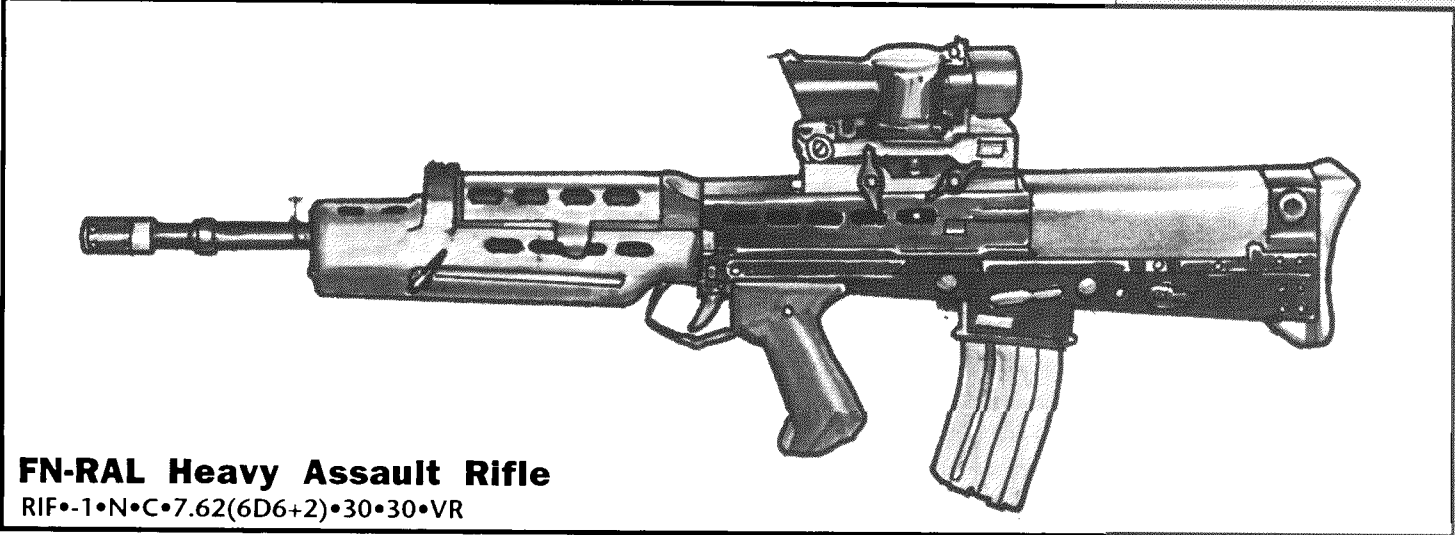

**FN-RAL Heavy Assault Rifle**  
 RIF•-1•N•C•7.62(6D6+2)•30•30•VR

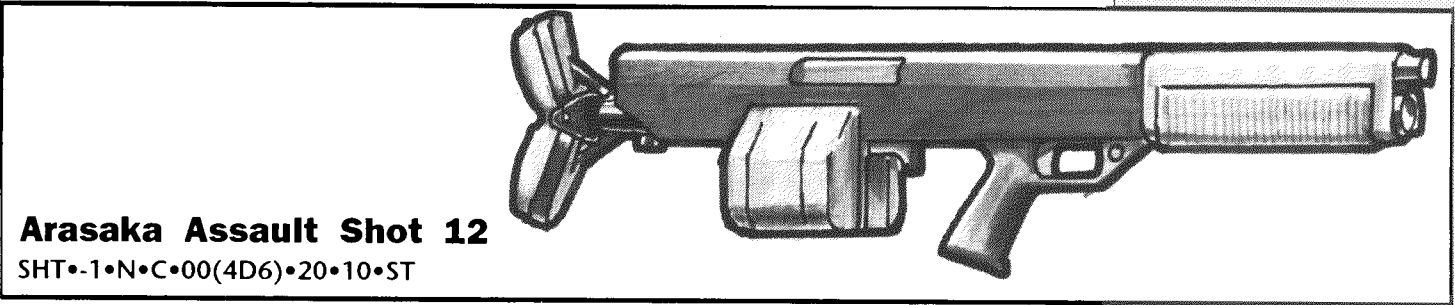

**Arasaka Assault Shotgun 12**  
 SHT•-1•N•C•00(4D6)•20•10•ST

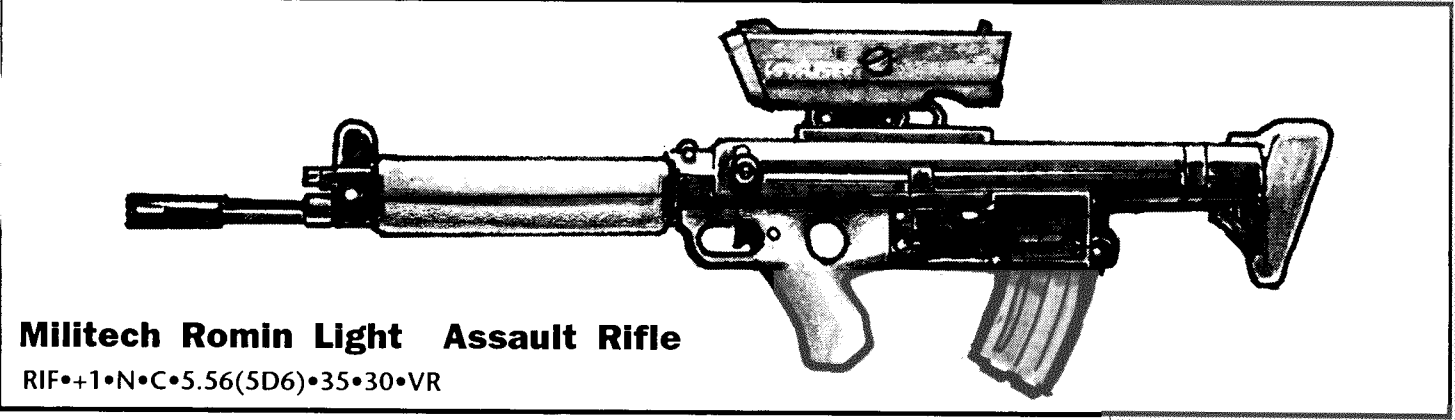

**Militech Romin Light Assault Rifle**  
 RIF•+1•N•C•5.56(5D6)•35•30•VR

*"Let's face it; for all the new hardware that's out there, most of it still does the same job—throw a chunk of lead through a man's body at near supersonic speeds. Plastic frames and caseless ammo are just icing on the cake..."*

*—Morgan Blackhand  
The Enforcer's Handbook*

### Old Guns Never Die

As late as the 1990's there were still used models of the venerable Beretta and Webley for sale (particularly in pawnshops and on the black market). The same can be assumed for 20th century weapons in 21st century—large numbers of "obsolete" weapons that can be found at reasonable prices in any pawn shop. Prices are usually half that of a comparable new weapon of the type, although final price is up to the Referee.

#### S&W Combat Magnum

SMG 0 C R 4D6(.357) 30 20 ST  
Designed for US Border Patrol use, the Combat Magnum is a popular choice among police officers. Its "small frame" and reliable action make it a best seller.

#### Llama Comanche

RIF 0 N E 5D6(7.56) 30 20 VR  
An excellent .44 revolver, used in home defense and police work. It's long barrel makes it hard to conceal.

#### Colt .45 "Peacemaker"

RIF 0 N E 5D6(7.56) 30 20 VR  
The gun "that won the West", the .45 was the most common US sidearm throughout the 1800's. A single action weapon, it must be cocked before firing, although later models had a flattened hammer allowing the gun to be fired by "fanning" the hammer.

#### Colt .38 Detective

RIF 0 N E 5D6(7.56) 30 20 VR  
The most commonplace police weapon for many years, the Colt .38 has many variants, including the smaller "Chief's Special". With their high reliability, there are many of these guns still in circulation.

#### C.O.P. .357 Derringer

RIF 0 N E 5D6(7.56) 30 20 VR  
Designed as a "holdout" for law enforcement agents, the COP uses a unique revolving firing pin arrangement. It's small size makes it easily hidden.

#### UZI

SMG 2 J C 2D6+1(9mm) 30 20 VR  
Developed by the Israelis as a reliable export weapon, the UZI is used worldwide by security forces, the US Secret Service, police and (unfortunately) terrorists and drug dealers.

#### Vz61 Skorpion

SMG 2 J P 1D6(.25) 20 25 VR  
A standard military sidearm for the Soviet Bloc, the Skorpion is the world's smallest military SMG. It's small ammunition size gives it excellent controllability. It is easily silenced and can be carried in a shoulder holster.

#### Ingram MAC 10

SMG -1 J C 2D6+2(.45) 30 5 UR  
A very small SMG used by covert units and terrorists. It can be easily silenced. However, it's very large ammo size makes it very difficult to control when on full auto.

#### H&K MP5 & MP5K

SMG 1 L C 2D6+1(9mm) 30 20 ST  
Two examples of the H&K family of interchangeable SMGs, both share parts and design similarities. The MP5K is a very small version of the MP5SD3, which has a built in silencer.

#### Thompson M1

SMG 2 N C 2D6+2(.45) 30 20 VR  
Standard US military SMG during WWII, the Thompson is rugged, reliable and easy to use. The M1928 version, of gangster fame, was less reliable (UR), but could carry a 50 round drum magazine.

#### Bushmaster

SMG 0 C R 4D6(5.56) 30 20 ST  
A bullpup configured SMG designed to be fired one handed. The Bushmaster uses the M-16A1 clip, making it technically closer to an assault rifle than a submachinegun.

#### FN-FAL

RIF 0 N E 6D6+2(7.56) 20 21 VR  
Standard NATO rifle. A very deadly assault weapon; durable and handles well.

#### AK 47, AKM, AKMS

RIF 0 N E 5D6(7.56) 30 20 VR  
Standard Soviet military rifle, exported worldwide, particularly to Soviet client-states. Reliable, rugged, but rather difficult to control, the AK-47 is probably the most well known weapon of it's type in the world.

#### M-16A & M-16A2

RIF 2 N C 4D6(5.56) 30 25 UR  
Standard US military rifle since the 1960's, the M-16 has high accuracy and a staggering ROF. A built in "tumble" effect compensates for the light 5.56 round. Earlier M-16 models were cantankerous and unreliable in the extreme, with an accuracy of 1, not 2. The Ar-15 and the AR-180 are civilian models used by police and home defense.

#### Styer Aug

RIF 2 N C 4D6(5.56) 30 20 VR  
A bullpup configured rifle using high tech plastics and aluminum, the AUG is the wave of the future. The scope is built in, giving it great accuracy, while it's rugged plastic construction gives it reliability and strength.

#### Winchester M70

RIF 3 N C 5D6+1(30-06) 5 1 VR  
A basic scoped hunting rifle, used to hunt deer.

#### CAWS

SHG 0 N R 4D6(00) 10 10 ST  
Close in Assault Weapon, designed for house to house work, crowd suppression. Scope is built in, making it very accurate for type.

## Armor

This is the next most important purchase for the well-dressed punk. Most armors in the 2000's are made of epoxide laminates, plastic mesh weaves and thin metal or ceramic insert plates. They are light, but often bulky; each one has an **Encumbrance Value (EV)** which is subtracted from your character's REF, and a **Stopping Power (SP)**, which refers to the ability of the armor to stop damage. The Stopping Power is subtracted from the amount of damage done by the hit. Armor includes:

#### Heavy leather (Jacket or Pants) SP=4

Good for road rash, stopping knives, etc. A good .38 slug will probably rip you to bits, however.

#### Kevlar T-Shirt/Vest SP=10

Can be worn unobnoxiously under most street clothes. Will stop most rounds up to a .45 ACP.

#### Kevlar Armor Jacket SP=14 (Lt), 18 (Med) or 20 (Hvy)

Personal protection for the fashion conscious, these lightweight Kevlar jackets have nylon coverings that resemble normal jackets.

**BODY ARMOR**

Type of Armor	Covers	SP*	EV†	Cost
Cloth, leather✓	Arms, Torso, possibly legs	0	+0	Varies
Heavy leather	Arms, Torso, possibly legs	4	+0	50 <sup>00</sup>
Kevlar T-Shirt, Vest✓	Torso	10	+0	90 <sup>00</sup>
Steel helmet	Head	14	+0	20 <sup>00</sup>
Light Armor jacket✓	Torso, Arms	14	+0	150 <sup>00</sup>
Med Armor jacket✓	Torso, Arms	18	+1	200 <sup>00</sup>
Flack vest	Torso	20	+1	200 <sup>00</sup>
Flack pants	Legs	20	+1	200 <sup>00</sup>
Nylon helmet	Head	20	+0	100 <sup>00</sup>
Heavy Armor jacket✓	Torso, Arms	20	+2	250 <sup>00</sup>
Door Gunner's vest	Torso	25	+3	250 <sup>00</sup>
MetalGear™	Whole Body	25	+2	600 <sup>00</sup>

Stopping Power (SP) refers to the ability of the armor to stop damage  
 \*AP rounds: treat all Armor as 1/2xSP †=Edged weapons treat SP as half  
 † (EV) Encumbrance values should be added together and subtracted from character's total REF stat.

**Helmet** SP=14 (steel) or 20 (nylon)

Heavy duty protection for the head, standard for most military. Some are made of steel, others of kevlar and high impact plastics. Most (90%) have face shields with 1/2 the SP level as the rest of the helmet.

**Flack Vest/Pants** SP=20

Standard protection for combat soldiers, the flack vest is designed to stop small arms fire, grenade shrapnel, but only slow up assault rifle rounds.

**Doorgunner's Vest** SP=25

Heavy duty protection for stationary positions, like machinegun nests, helicopter doors, etc.

**MetalGear™** SP=25

Laminated expoxide plate armor. Bulky and designed in modular sections, with helmet, arm & leg coverings, torso and back clamshell.

**Special Equipment**

Okay, so you don't wanna get all metalled up and hard into the face, neh? No problem. We got a couple of slick little gadgets to put you even up with the cybers.

**BattleGloves (900<sup>00</sup>)**

Heavy gauntlets that cover the entire hand and forearm, articulated with artificial muscle and hydraulics. A Battle glove delivers 3D6 crushing, 2D6 punching damage, and has three spaces for any standard cyberarm weapon or option, except Hydraulic Rams.

**Smartgoggles (200<sup>00</sup>)**

Want all the advantages of getting cyberoptics, but without the humanity loss? Smartgoggles can be outfitted with chips to simulate the effects of up to 4 cyberoptic options (each option costs the same as a cyberoptic option, less 10%). Smartgoggles come with a smartgun plug and cables, allowing the Targeting scope option to be used (+1 to ranged attacks).

*For example, Razorjack decides to buy a set of smartgoggles. He selects Thermograph, Digital camera, Low Lite and Targeting scope as options. His total cost is 200<sup>00</sup> (base cost) + 990<sup>00</sup>=1190<sup>00</sup>*

**Linear Frames (Price Varies)**

A linear frame is a powered exoskeleton, giving the user tremendous strength. There are three levels of linear frames: *Sigma*, *Beta* and *Omega*.

Type	Strength	Cost
Σ (Sigma)	12	5000 <sup>00</sup>
β (Beta)	14	7000 <sup>00</sup>
Ω (Omega)	16	9000 <sup>00</sup>

Normally, exoskeletons are worn as part of a cybernetics package (see *Putting the Cyber Into The Punk*, pg.92 for more details). However, you can put on a linear frame without having it interfaced directly to your nervous system. Instead, you can simply chip into the suit as if it were any cyberbike or vehicle, taking a -2 REF penalty to do so.

Not bad, eh? Just make sure they don't take 'em off ya, chombatta.

*"So what if armor makes you slower? You still can't outrun a bullet. But you can stop it dead in it's tracks."*

*—Nomad Santiago*

# 2020 GEAR LIST

Following is a list of useful items for the cyberpunk on the move.

## FASHION†

Pants .....	20.00
Top .....	15.00
Jacket .....	35.00
Footwear .....	25.00
Jewelry .....	10-100.00
Mirrorshades .....	5-50.00
Contact Lenses .....	100.00
Glasses .....	50.00

†Multiply base cost by style:

Generic Chic .....	1x cost
Leisurewear .....	2x cost
Businesswear .....	3x cost
High Fashion .....	4x cost
Urban Flash .....	2x cost

## TOOLS

Techscanner .....	600.00
Cutting torch .....	40.00
Tech Toolkit .....	100.00
B & E Tools .....	120.00
Electronics Toolkit .....	100.00
Protective Goggles .....	20.00
Flashtube .....	2.00
Glowstik .....	1.00
Flash Paint .....	10.00 per pt.
Flash Tape .....	10.00 per foot
Rope .....	2.00 per foot
Breathing Mask .....	30.00

## PERSONAL ELECTRONICS

Holo Generator .....	500.00
Video Board .....	100.00 per sq ft
Data Chip .....	10.00
Logcompass .....	50.00
Digital Recorder .....	300.00
Digital Camera .....	150.00
VideoCam .....	800.00
Video/Audio Tape Player .....	40.00
VideoTape .....	4.00
Pocket TV .....	80.00
Digital Chip Player .....	150.00
Digital Music Chip .....	20.00
Electric Guitar .....	100-500.00
Electronic Keyboard .....	200-900.00
Drum Synthesizer .....	200-800.00
Amplifier .....	500-1000.00

## DATA SYSTEMS

Laptop Computer .....	900.00
Pocket Computer .....	100.00
Cybermodem .....	Varies by design
Cellular Cybermodem .....	Varies by design
Interface Cables .....	20-30.00

Low Impedance cables .....	60.00
'Trode Set .....	20.00
Keyboard .....	100.00
Terminal .....	400.00

## COMMUNICATIONS

Mastoid Commo .....	100.00
Pocket Commo .....	50.00
Cellular Phone .....	400.00
Mini Cell Phone .....	800.00

## SURVEILLANCE

Binoglasses .....	200.00
Binoculars .....	20.00
Light Booster Goggles .....	200.00
IR Goggles .....	250.00
IR Flash .....	50.00

## ENTERTAINMENT

Movie .....	10.00
VCR/Chip Rental .....	4.00
Braindance .....	20.00
Live Concert/Sports Event .....	50.00
Fast Food Meal .....	5.00
Well Drink† .....	3.00
Restaurant Meal† .....	20.00

†Multiply by level of restaurant or bar:

Fair .....	1x cost
Good .....	2x cost
Excellent .....	3x cost

## SECURITY

Keylock .....	20.00 per level
Cardlock .....	100.00 per level
Vocolock .....	200.00 per level
Line Tap .....	200.00
CodeDecryptor .....	500.00
VocDecryptor .....	1,000.00
Security Scanner .....	1,500.00
Poison Sniffer .....	1,500.00
Jamming Transmitter .....	500.00
Scanner Plate .....	500.00
Movement Sensor .....	40.00
Passcard .....	10.00
Tracking Device .....	1,000.00
Tracer Button .....	50.00
Remote Sensors .....	700.00
PlasKuffs .....	100.00
Stripwire Binders .....	5.00

## MEDICAL

Dermal Stapler .....	1,000.00
Spray Skin .....	50.00 per can
Slap Patch .....	varies by drug type
Cryotank .....	100,000.00
Medkit .....	50.00
Surgical Kit .....	400.00
First Aid Kit .....	10.00
Medscanner .....	300.00

Drug Analyser .....	75.00
Airhypo .....	100.00
Clinic Visit .....	200.00
Day in Hospital .....	300.00
Day in Intensive Care .....	1,000.00
Clone Limb Replacement .....	1,500.00

## FURNISHINGS

Nylon Carrybag .....	5.00
Sleeping Bag .....	25.00
Inflatable Bed .....	25.00
Futon .....	90.00
Real Wood Furniture .....	200.00 per piece
Synthetic Furniture .....	100.00 per piece
Apartment Cube .....	5,000.00
Lamp .....	20.00
Cleaning Bot .....	1,000.00
Vocal Switcher System .....	100.00

## VEHICLES

Scooter .....	500.00
Motorcycle .....	1,500.00
CityCar .....	2,000.00
Small Subcompact .....	6,000.00
Medium Sedan .....	10,000.00
Sportscar .....	20,000.00
Luxury Sedan .....	40,000.00

Note: 2x cost for cybercontrols

## LIFESTYLE

Cell Phone Service .....	100.00 month +
Standard Phone Service .....	30.00 month+
Pay Phone Call .....	50¢ per minute
Data Term Use .....	1.00 per minute
CredChip Account .....	20.00 per month
Health Plan .....	1,000.00 per month
Trauma Team Acct. ....	500.00 month
Air .....	5.00 per minute
Mag Lev Chit .....	25¢ per station
Taxi .....	3.00 per mile
AV-Taxi .....	10.00 per mile
Cable TV .....	40.00 per month

## GROCERIES

Kibble .....	50.00 per week
Generic Prepak .....	150.00 per week
Good Prepak .....	200.00 per week
Fresh Food .....	300.00 per week

## HOUSING†

Coffin .....	20.00 per night
Hotel Room .....	100 per night
Apt./Condo .....	200.00 per room/per month
House .....	150.00 per room/per month

†Multiply base cost by location:

Combat Zone .....	1x cost
Moderate Zone .....	2x cost
Corporate Zone .....	4x cost
Executive Zone .....	6x cost
Utilities .....	100.00 month



## GEAR DESCRIPTIONS

## Fashion

The clothing styles of 2020 break into five basic fashion statements:

**Generic Chic:** This is the standard Streetwear, made up of colorful modular components in many colors. Belts, coats, sashes, boots predominate.

**Leisurewear:** This is the equivalent of 21st century athletic wear. Padded fleece, corporate and athletic logos.

**Businesswear:** This is the equivalent of the standard business suit; understated colors, pinstripes, real leather shoes etc. Wool and other natural fabrics are considered the proper outfitting for the up and coming Corp.

**High Fashion:** Sophisticated and expensive dressing for the upper class. Designer labels like Miyake, Si-fui Yan, and Anne Calvin.

**Urban Flash:** Video jackets, colorshift fabrics, cammo, leathers, metal spikes, Logowear, jeans, leather skirts, boots. The wildest and most utterly chilled in cyberfashion.

## Tools

**Techscanner:** a small handheld microcomp with various I/O connectors and probes. Techscanners run diagnostic programs, identify and examine malfunctioning components, and display internal schematics on a small screen.

**Cutting Torch:** common oxy/acetylene type out of a bottle. Hand held, about a foot long. More powerful models are available, up to thermite lances at 5x-15x cost.

**Tech Tool Kit:** mixed kit of tools for repair of mechanical items, usually in a 4"x16"x2" case.

**Electronics Kit:** see above.

**Protective Goggles:** protective eyewear for welding, metal machining work, chemical mixing, etc.

**Flashlight:** you all know what this is. Beam range 100'-120'. Can buy smaller pocket lights (1/4 range) for half the normal price.

**Glowstik:** chemlight in a 6" plastic tube. Shake or break to activate. Soft light lasts up to 6 hours. Comes in green, blue, red.

**Flashpaint:** fluorescent paint gives off soft light equal to Glowstik, lasts up to 4 hours.

**Flashtape:** same as Flashpaint. Lasts 6 hours, comes in variety of widths.

**Rope:** braided synthetics in a variety of thicknesses and weights. Can hold up to 1,000 lbs.

**Breathing Mask:** a common painter's style mask; nose and mouth coverage, with two replacable filters (1 eb per 10 pack) on the sides. Good for keeping out the smog.

## Personal Electronics

**Holo Generator:** small box (approx. 4"x2"x6" inches) projects a holographic picture from a replacable chip. Generator is compatible with chips from most digital cameras. Can be linked with a digital Recorder/Player.

**Video Board:** monitor using flat-LCD technology. No thicker than an inch, most video boards are built into TVs, but all types have input plugs for use as a readout monitor for other electronic products. Large ones (20'x100') are used as advertising signs. Videoboard are bought by the square foot.

**Datachip:** the storage medium of the future for holding digital information. Usually plastic-cased, chips come in the shape of buttons, flat squares, and triangular slivers. All shapes can be read by all types of recording media by use of adapter plugs.

**Logcompass:** a form of programmable inertial compass

that keeps track of your changes in direction from a fixed bearing or point.

**Digital Recorder:** audio recording device using datachip technology, most are the size of two paperback books stacked flat. Some are smaller than a pack of cards.

**Digital Camera:** still images are "digitized" onto a chip cartridge. About the size of a pack of cigarettes.

**VideoCam:** can be mounted on a headset, a shoulder clamp, or hand-held depending on size (This affects price, size of recorded image, duration of recording time, etc. The price given is for the most inexpensive shoulder-carried model.) Sound and image are usually recorded on a tape-pak that is the size of a card deck or smaller, but you can direct-feed to a transmission device with a set of cables.

**Video/audio Tape Player:** this device plays the videocam tape-paks, along with many older-style audio tapes.

**Video Tape:** see VideoCam. Note: the video tape of 2020 is a high density digital media capable of handling both audio and visual images.

**Pocket TV:** uses a flat-scan screen in a package 5"x5"x3/4" or smaller. Picks up the majority of VHF, UHF stations.

**Digital Chip Player:** this plays audio- and video-recorded chips. You must plug into a video board to play the video track of a digital chip.

**Digital Music Chip:** 1 to 6 pop album favorites (or any other music) slapped into semiconductors and plastic. These chip are also available in a read-write format as well.

**Electric Guitar:** no longer the classic "axe", it's now lighter, more flexible in its applications, and sometimes not even in a recognizable shape. It may have even replaced the strings and frets with a series of key banks!

**Electronic Keyboard:** little changed from the present, except in size and power.

**Drum Synthesizers:** common "new-wave" music equipment; a series of percussion pads and a sound box. It will fit in a couple of suitcases and can be arranged any way the drummer pleases.

**Amplifier:** see electronic keyboard. (For more on the instruments of the 2010s-20s, check out the supplement *Rockerboy*.)

## Data Systems

**Laptop Computer:** the common portable, with internal hard drive, video board (detachable), and slots for data/programming chips. These units do not have the advanced CPUs and memory spaces available in a regular computer system; they cannot be used for Netrunning.

**Pocket Computer:** the classic 6"x3"x1/2" programmable calculator with keyboard and chip slots, up to 100 pages of alphanumeric memory.

*"Sure, you got yer cyberwear. You got yer guns and yer armor. But you gotta sleep somewhere. You gotta eat somethin' besides kibble and bits. An' it don't hurt if you catch an occasional braindance or a little video action."*

*—The Bag Lady*

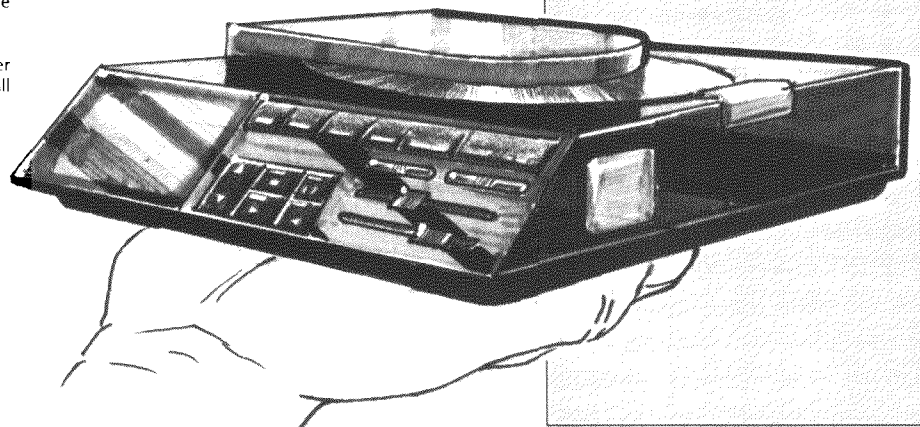

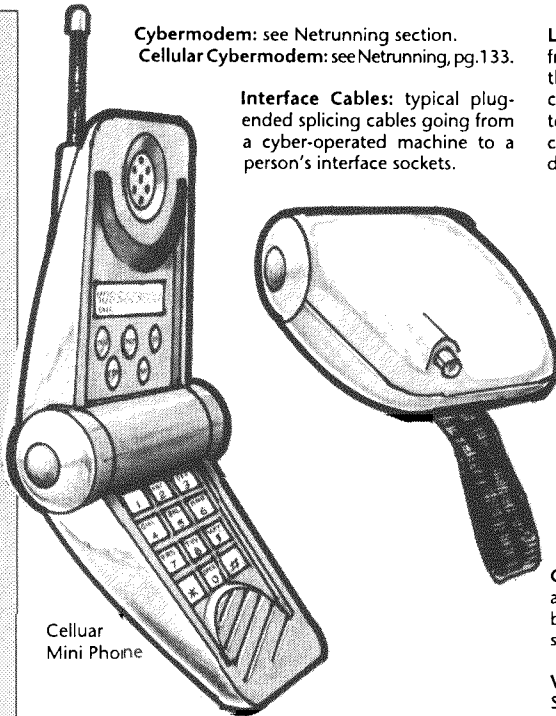

Cellular Mini Phone

**Cybermodem:** see Netrunning section.  
**Cellular Cybermodem:** see Netrunning, pg.133.

**Interface Cables:** typical plug-ended splicing cables going from a cyber-operated machine to a person's interface sockets.

**Line Tap:** a device that can pick up voice or data transmissions from a telecommunications line, then record or transmit them. The more sophisticated models need not be directly connected to the line they're monitoring (they will work up to a foot or so away), and can be remote controlled. Line taps cannot be used on systems installed or updated after 2008 due to the complete switchover to fiber optics.

### Security

**Keylock/Cardlock/Voclock:** increasingly complex methods of portal security. The keylock is a mechanical lock and must be attacked that way. Card- and voco-locks are electronic, (cardlocks use a magnetically-coded card, voco-locks employ voice-recognition technology). Each type of lock has four increasing levels of complexity, and a single security system may incorporate all 3 types of locks.

Type	Difficulty Level
Low Security .....	Average (15)
Medium Security .....	Difficult (20)
High Security .....	Very Difficult (25)
Maximum Security .....	Nearly Impossible (30)

**Cardlock Decryptor:** the probe of this device is inserted into a card lock instead of the normal card. A Decryptor operates by adding +5 to your basic TECH+Electronic Security+1D10 skill check against the lock.

**VocDecryptor:** a vocal modulator for penetrating voco-locks. See above.

**Security Scanner:** this device searches out electromagnetic fields generated by various alarm systems (75% chance of location). A TECH or INT roll may be needed to identify the style of alarm encountered.

**Poison Sniffer:** can be set to check air or liquid for a specific poison(s). Otherwise, it will simply alert you to foreign substances. 85% accuracy.

**Jamming Transmitter:** usually comes in 2 or 3 large cases, but can fill an entire van. Jams electromagnetic transmissions in a 1000 foot area (that includes cellular phones and some cyberware).

**Scanner Plate:** a reading device for palmpoint locks. Can be attached to any type of Card or Voclock to add an extra layer of security.

**Movement Sensor:** a typical alarm system. Covers seismic, sonar, and fixed IR or visible light networks. Detects movement in a defined area, with a 95% reliability. The sensory processor is about the size of a pack of cigarettes.

**Pascard:** the most common unlocking device for a cardlock.

**Tracking Device:** hand held or suitcased equipment for detecting/following tracer buttons. Range is 1 mile.

**Tracer Buttons:** can be any size from a matchbook to a pin. Uses radioactivity or constant/pulsed radio transmission to pinpoint who or what it's attached to. Some can be turned on/off remotely. Usually bought in sets of 6.

**Handcuffs:** just what it says. Probably a little stronger (a NEARLY IMPOSSIBLE task to break) due to new alloys. Often (50%) opened with a form of cardlock.

**Striptape Binders:** great for riot control. One-use-only plastic locking strips for temporary handcuffs and leg ties (VERY DIFFICULT to break). With ceramic fibers to resist cutting, and guaranteed fireproof. Come in boxes of 12.

### Medical

**Dermal Stapler:** this automatically pulls the sides of a wound together and sutures it with staples of a compressed organic material that dissolves after an elapsed time.

**Spray Skin:** a putty-like spray gel for treatment of severe abrasions. Antiseptic and sterile, it's also air permeable and flakes off in about two weeks.

**Low Impedance Cables:** special low-resistance/interference cables for improved data transfer; they confer a +1 bonus on any interfacing tasks, such as controlling cybervehicles or Netrunning.

**Trode Set:** a low efficiency headset for 'piggybacking' in the Net. -2 to Interface skill.

**Keyboard:** can be accessorized to your cybermodem or other electronic equipment.

**Terminal:** a computer workstation including keyboard, video board, and I/O connectors. A terminal can be used to Netrun (making the runner immune to most Black software), but is very, very slow (-5 to Interface Skills). Terminal operators are commonly known as "net-tortoises"

### Communications

**Mastoid Commo:** all commos are radio transceivers. This one is glued to the jaw and temple; you send via subvocalization and receive with soundless vibrations. Range 10 miles.

**Pocket Commo:** a typical small walkie-talkie. Range 10 miles.

**Cellular Phone:** communication on the move, anywhere within reach of a radiotelephone transceiver network. There is a 100eb per month phone service charge.

**MiniCell Phone:** it fits in a cigarette pack.

### Surveillance

**Binoculars:** 'nuff said.

**Binoglasses:** these high-tech vision aids combine binocular effects with a laser rangefinder, and sometimes IR lenses. More expensive versions will have a digital camera built in.

**LB Goggles:** light intensification goggles boost ambient light for night vision via 'Starlite' technology. Goggles can be overwhelmed by sudden light level increase. With tuning (DIFFICULT task), they can also detect active IR beams.

**IR Goggles:** these pick up hazy, background Infrared sources. Normally used with an active IR source for invisible illumination.

**IR Flashlight:** see above. UV flash is similar; also useable with the proper cyberoptic.

*"Whoa. A brand new Hitachi-Zendaflex! I always wanted one of those; frack, ever since I was a punk. It's real nice of this dead guy here to give me his! Really appreciate it, chombatta!"*

*—Ripperjack*

**Cryotank:** an advanced refrigeration tank; the cryotank will cool a body down to preservation levels while life-support machines maintain the blood/oxygen flow. Designed to keep a dying body in relative stasis.

**Medkit:** standard doctor's or military corpsman's bag. It contains antidotes, dressings, drugs, applicators, medicines, and examining instruments (probes, depressors, ocular light, stethoscope).

**Surgical Set:** a full set of surgeon's tools (scalpel, retractor, probe, clamp, tweezer, etc.), and chemicals or equipment for maintaining a sterile operating field.

**First Aid Kit:** the common household medic's box. It has bandages, antiseptics, and a simple painkiller.

**Slap Patch:** a small plastic pad containing a measured amount of medicine. The pad is applied to the skin and the medicine is absorbed in steady doses. See the *Trauma Team* section for drugs and prices.

**Airhypo:** the "Bones McCoy" uses a quick burst of compressed air to force a liquid drug through the skin. See the *Trauma Team* section for drugs and prices.

**Medscanner:** Readouts for body temperature, heartrate, blood pressure, respiration, and blood sugar levels. A small chipped database adds a +2 to your *Diagnose Skill*.

**Drug Analyser:** ranging in size from a book to a briefcase, this gadget operates in a manner similar to the chemical sniffer. It will determine the purity of a drug with a known composition, or identify the molecular makeup and possible effects of an unknown substance that is similar to a drug already programmed into its library.

## Furnishings

**Nylon Carrybag:** the athletic bag/kitbag of the 2000's, with a variety of logos to choose from. Sizes vary.

**Sleeping Bag:** they're lighter weight, and can now take temperatures down to -100F. Compresses to a 12"x6"x4" wad.

**Inflatable Bed:** self-inflating, highly-compressed mattress package. About 6"x2"x4" folded.

**Real Wood Furniture/ Synthetic Furniture:** what more can we say?

**Futon:** portable folding bed and pad; of Japanese origin.

**Apartment Cube:** 10'x10'x8' living module in which all major furnishings and appliances are hidden in flush wall recesses and are extended only for use. Contains bed, closet, small stove, refrigerator, TV and digital entertainment center, two chairs, fold down desk, removable table. Rolls into place and can be easily transported. Cubes are usually so small that if you had all your furnishings extended at once, there'd be no room for you to stand!

**Lamp:** it gives light. Comes in an infinity of shapes and colors.

**Cleaning Bot:** small preprogrammed robotic cleaning device. Usually about the size of a portable cannister vacuum. Not too smart.

**Vocal Switching System:** voice-activated controls for lights and appliances.

## Vehicles

Following are typical vehicles of the early 21st Century. For specific models, see *All Things Dark & Cyberpunk*, pgs. 180 through 182.

**Scooter:** this is an updated, electrically powered version of the old Riva and Vespa motorscooters of the 1990's. Top speed about 50 mph, scooters can get about 6 hours of travel per fastcharge (about 5 minutes at any service station).

**Motorcycle:** these are updated versions of standard motorcycles. Most are recumbent designs, with plastic fairings that close over the driver. About half are electrically powered, with top speeds of 65mph and about 8 hours travel per fastcharge. CHOOH<sup>2</sup> powered versions have a top end of 140mph and a four gallon tank.

**CityCar:** one man (two in a pinch), three wheelers common in the Corporate Zones. Top speed about 40mph, with 4 hours travel per fastcharge. CityCars can also be rented (2<sup>00</sup> eb per mile) from convenient kiosks located around most corporate areas; you use your debit card to rent from the vendor, drive where you want, and drop the car off at the nearest vendor.

**Small Subcompact:** usually methanol or CHOOH<sup>2</sup> powered, these vehicles have a top speed of around 90mph, a ten gallon tank and seat four in relative comfort.

**Medium Sedan:** methanol or CHOOH<sup>2</sup> powered, these vehicles have a top speed of around 90mph, a fifteen gallon tank and seat four.

**Sportscar:** almost always CHOOH<sup>2</sup> powered (electrics just don't have the speed). Top speed about 210, with a ten gallon tank. Seats 2.

**Luxury Sedan:** methanol or CHOOH<sup>2</sup> powered, these vehicles have a top speed of around 90mph, a twenty gallon tank and seat six.

**Fastcharge:** rapid (5 minutes) battery-recharge for electric vehicles. Available at most service stations for 20 eb per charge.

**CHOOH<sup>2</sup>:** synthetic meta-alcohol fuel. About 1D6/3+1 euro per gallon (the cost fluctuates wildly due to supply, demand and eco-terrorist activities).

## Lifestyle

**Data Term™:** this is a curbside computer terminal, with access to news, weather, city maps, events schedules and other useful stuff. A DataTerm can also be used as a plug-in point to the Net. Terms are mounted in concrete pillars and are nearly indestructible. Theoretically.

**CredChip Account:** a "debit card" that you use to carry your cash around in instead of a wallet.

**Air:** just what it says. In the U.S., Britain, and some parts of Eastern Europe, the daily pollution gets so bad that you need to go to a miscellany of 'air bars', vendors, or streetcorner machines to buy a decent breath.

## Groceries

**Kibble:** a mass-produced nutrient that satisfies most requirements for sustenance, but tends to look, smell, and taste like the dry pet food it takes its name from.

**Generic Prepack:** a step up from the common TV dinner, these meal packs can be microwaved or refrigerated depending on what's inside. Many come with their own chemtabs for heating or cooling. The cuisine isn't inspired, but it beats kibble.

**Good Prepack:** good restaurant meals in a package. The best quality pre-made meals you're going to find. For anything better, eat out, or prep it yourself (and who really knows how to do that anymore?).

**Fresh:** you know what that is. Well, at least you've met someone who's eaten it.

## Housing

**Coffin:** one step up from a sleeping bag on the street. A stacked accommodation which resembles its namesake, these sleeping boxes are found in airports and flophouses worldwide. Usually coin-operated with a time limit, the coffin gives you just enough room to turn around or read in bed; restroom accommodations to be found elsewhere. More expensive models will have a phone or mini-TV inside.

*"The new BMW-Infiniti aerodyne. Fifteen thousand pounds of raw thrust. Available on demand cyber-avionics. And the most sophisticated audio system ever installed in an AV-7. BMW-Infiniti. You can't call yourself a Cyberpunk until you've bought one."*  
—Radio Ad, 2019

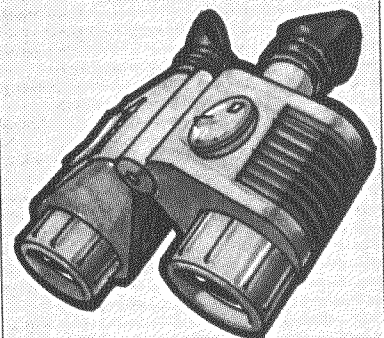

GEAR  
CYBERWEAR  
COMBAT

SECTION

6

# PUTTING THE CYBER INTO THE PUNK

**Forget everything you ever thought about cyborgs. Everything.**

This is the 2000's. Today's cyborg is stylish. His cybernetics are designed for a streamlined, highmover lifestyle. Whether equipped with implanted data chips in his nervous system to enhance his tennis game, or bio-engineered miniweapons for his personal protection, the cyborg of the 2000's is the cutting edge of high tech living.

But he isn't necessarily a walking tank either. Cybertech can be smoother than that—less obvious. You have to integrate your newtech gadgets into a slick, seamless whole. You're either predator or prey, and the faster you learn to blur the line between the two categories, the longer you'll survive.

And that's the point. Survival.

## Cyberfashion

It's hip and aware to have high tech grafted onto your body somewhere. If you can afford it, you probably have at least a couple of "enhancements"; a few software chips installed in your nervous system to interface with your computer, remember your appointments (the ever popular *Daytimer*™ chip for example), and improve your raquetball reflexes. If you're *cybered up* you probably have interface plugs to operate computers and vehicles mentally. Maybe your eyes are cyberoptics with a recording function and the latest iris tint (polychrome is in this year), or your hearing is boosted to better hear the gossip in the Executive Lounge.

If your job involves some type of security or combat function (and most occupations of the 2000's have at least some type

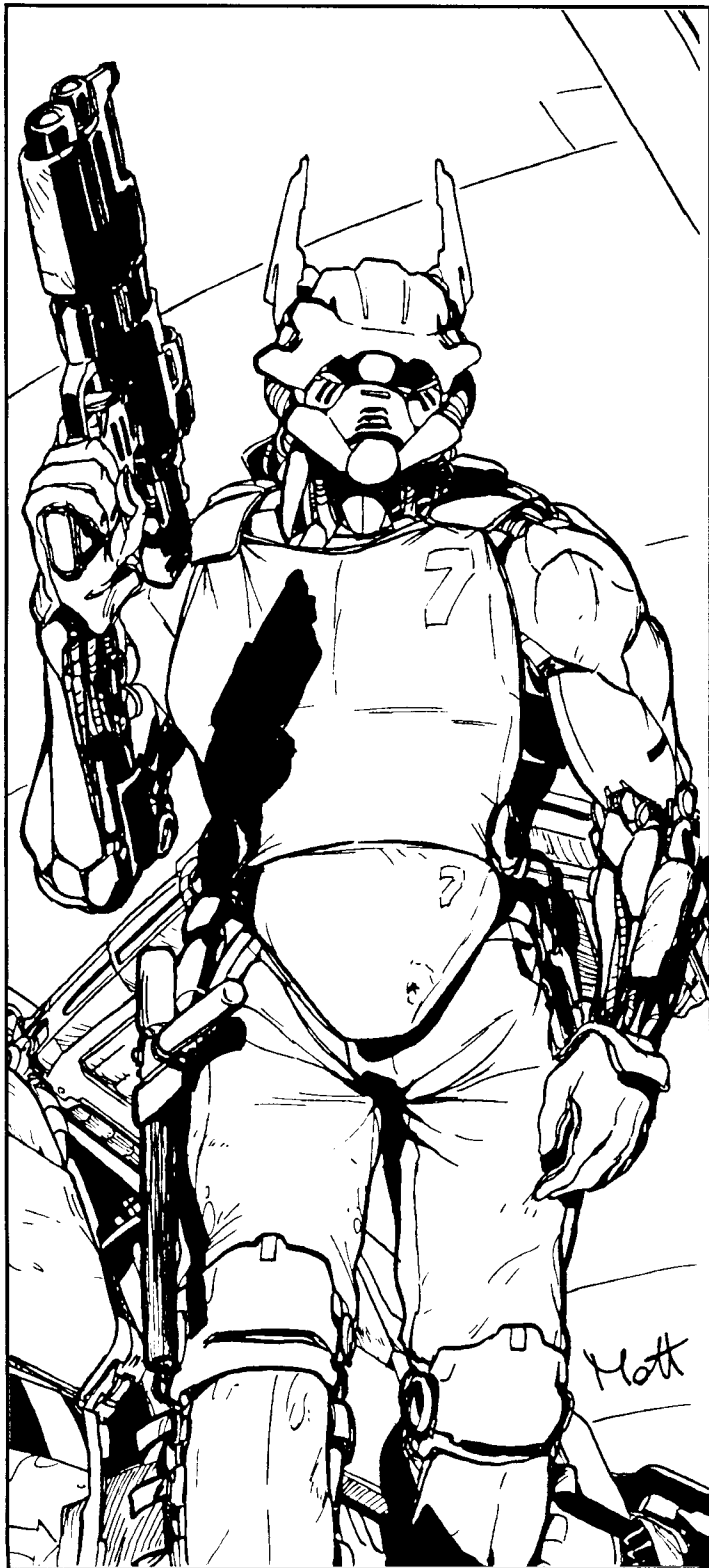

of combat aspect), you probably have two or three types of combat software, as well as plugs and interfaces for a smartgun. As a Solo, you may have had one or more limbs replaced with cyberware prosthetics, allowing you to hide a variety of tools and weapons in your body, as well as giving you an edge in speed and strength.

As a cyberpunk, you're going to want to get your hands on the best of this exciting and expensive new tech. And expensive is the word. The average enhanced character with, say, one cyberoptic (Targeting scope & IR enhancement), a reflex boost, one superchromed arm with a .25 cal submachinegun, interface plugs and chipware for *Martial Arts*, *Rotorwing Pilot* and *Handgun* is an investment of tens of thousands of euro.

Of course, the ambitious Punk already knows at least twenty-five ways (most of them illegal) to raise that sort of paltry sum.

But before you start loading up, there's a catch.

## Cyberpsychosis

Something happens when you start adding metal and plastic to people. They start to change. And it isn't pretty.

In the 2000's, we call this **cyberpsychosis**; a mental disease in which the addition of cybernetics causes an already unstable personality to fragment. At first, the victim begins to relate more to machines than to humans. Soon, he starts to ignore people—parents, friends, lovers. Eating, sleeping all become less important. Finally, human interactions begin to irritate, culminating in a terrifying rage that consumes the victim entirely.

*So, how do I get cyberpsychosis?*

Every character in Cyberpunk has an Empathy stat (EMP). This stat is a measure of how well the character relates to other

people, and is the basis of such skills as leadership, lying, convincing and romantic relationships.

Likewise, every major cybernetic enhancement has a corresponding **Humanity Cost**, which is added together to get an overall Humanity Cost of all enhancements. Humanity Costs are rated from VERY LOW to VERY HIGH, and correspond to the general effect this enhancement will have on the human psyche. In addition, each option added to an enhancement has an additional point value as well.

For every ten points of Humanity Cost, the character loses one point of Empathy (unequal values are rounded down).

*For example, say I add four new cybernetic devices for a total Humanity Cost of 36. I will lose 3 points of Empathy.*

This can start to cost you. With an Empathy of 3 the character is something of a "cold

fish"; emotionless and cold. With an Empathy of 2, the character is chilly, forbidding, and distinctly unpleasant to others. With an Empathy of 1, the character is usually violent, sociopathic and vicious. He must constantly fight to keep from going over the edge and committing irrational, violent acts of murder and mayhem.

At an Empathy rating of 0 or less, the character is fully in the grip of cyberpsychosis. He is driven by a maddening hatred of other humans or living things. At this point, there is no turning back—the character is taken over by the Referee, who plays it as a non-player character with all the worst attributes of a murderous, mechanized psychopath, called a **cyberpsycho**.

Not all cyberpsychos are the rampaging type. Many exhibit more subtle symptoms; compulsive lying, kleptomania, sadism, brutality, split personality and extremely violent mood swings.

***The cyberpsycho must constantly fight to keep from going over the edge and committing irrational, violent acts of murder and mayhem. Most of the time, he loses.***

***Then everybody loses.***

***"They're so...like...weak and flimsy, you know? You just reach out and touch 'em, and they...die..."***

***—Unknown  
Cyberpsycho***

***"The guy weighed in at about 550, once you counted in the metal. When we took him down in the maglev station, he'd already killed fifteen people. He said he couldn't stand all those flimsy sacks of blood and water, hemming him in...."***

***—Sgt. Max  
Hammerman, NCPD***





*"What's a nice little girl like you doing working C-SWAT?"*

*"Hunting down frack like you wireheads in Vice, sweetie..."*

*—Typical conversation  
Night City Precinct*

### The Psycho Squad

Cyberpsychosis is a big problem in the 2000's. While state-sponsored therapy is an option, the hardest part is getting the patient into the psychologist's office. What do you do when a metal armored, cyberboosted maniac starts randomly killing people? If you're the Government, you organize a special squad of professional police with one job—to hunt down and capture or kill murderous cyberpsychos.

Cybersquads are common to most urban police departments, going under names like C-SWAT (Cybernetic Special Weapons & Tactical Squad), PSYCHE-DIV, CYB-Enforcement and MAX-TAC (Maximum Force Tactical Division). They are armed with the best in armor, commo equipment and vehicles. Most carry weapons that start at the light cannon range and up. They are, by nature, not very nice people.

### Registered Cybers

Although the Uniform Criminal Justice Code of the United States says you must actually commit a crime before you can be arrested, this doesn't stop most police departments from practicing selective crime prevention (especially those departments run by Corporations). The Psycho Squad

keeps tabs on who buys what and where through informants, monitors and hidden tech detectors scattered all over the city. They usually have a good idea what gangs are loading up on megaware and who's most likely to cross the line into psychohood in the near future. When a potential perp looks like he's getting too close, the Squad picks him up off the Street and offers him a choice. He can go on like he is and risk having an "accident" happen some dark night ("...we're just worried that some public-spirited citizen might, you know, take it upon himself to, well...you know...adjust your attitude..."), or you can get registered.

Registration is sort of like parole; you agree to see a cyberpsychologist for monitoring and analysis (regaining 2 points of HC per week until your original EMP is restored), and the squad implants a small transmitter into your cyberwear, allowing them to know your general whereabouts. Just in case. The police don't hassle you and the Squad doesn't automatically gun you down with 20mm cannon rounds if you boost a pack of *Smash* from the corner vend-mat.

It's rumored that some departments also

implant a small explosive charge and a radio detonator, but we all know that's against the Criminal Code, don't we?

Besides, you don't *have* to register. But we thought you'd like to know. After all, there are those public-spirited citizens out there...

**Humanity Costs**

*So how does all this apply to me?*

Simple. Each time you add on a cybernetic enhancement, there's a corresponding loss of humanity. But it's not simple, linear, or nice. Different people react differently to the cyborging process. Therefore, your Humanity Cost is based on the throw of a random dice value for each enhancement. This is important, because it means that sheer bad luck could put you over the line before you know it.

Very Low .....	1D6/2
Low .....	1D6
Medium .....	2D6
High .....	3D6
Very High .....	4D6

**Remember:** you must keep track of the cumulative number of points lost. Those little .5's and 1's are going to start adding up fast...

**Therapy**

There's one way to hang out over the Edge and still keep it wired, and that's therapy. The C-SWAT drags you in, screaming and tearing at the walls, and straps you down to a heavy metal psychiatrist's couch. Probes deactivate your cybersystems one by one, while the shrink jacks your rabid psyche into the braindance. Then begins the long, arduous process of disassembling your brain and reconstructing it in a more socially acceptable form. One that doesn't get its kicks out of eating dead bodies, for example.

**Cyberpsychologists** (Psychoshrinks) use combinations of braindance simulation, drugs, hypnotics, psychosurgery and aversion therapy to reconstruct damaged personalities. Once all cybernetics are removed or deactivated, the character will recover two points of EMP for every week of therapy attended.

*For example: Savage is dragged into Dr. Risk's office with a HC total of -3. It will take at least five weeks of therapy before Savage will be back to his original Empathy of 6.*

Now you know. Walk carefully. Guard your mind.

**Cybertechnology**

Cybertechnology can be purchased almost anywhere. Some of the medical procedures are simple, walk-in types of surgery, with minor installations taking place in shopping mall clinics (*Bodyshoppe, Fashion/Fusion, and Parts N' Programms* are three popular chain stores) or drop in medical centers (*Docs R Us™*). These installations are much like getting your ears pierced, circa 1980. You can even have upgrades and improvements plugged into the old hardware for the cost of the new parts, allowing you to start small (called stripped or economy) and add as you go.

What can't be bought openly are the types of cyberware known as Blackmarket Cybertech. These items can only be purchased through criminal contacts on the Street, and installed by high priced, underground medtechs known as **Ripperdocs**. Blackmarket cybertech is often dangerous, badly installed, and always expensive. But hey, we're all big kids here, and besides, you know what to do to a Ripperdoc who messes around with you, right?

**Surgery Codes**

Each type of cyberwear has a **Surgery Code**. This code represents the minimum level of medical care required to install the cyberwear, the length of surgical time required, the cost of the surgery, the damage taken in surgery and the Difficulty of the installation procedure.

Negligible

Required: Mall clinic or other drop-in bodyshop.

Surgical Time: 1 hr.

Surgical Damage: 1 point

Surgical Costs: Included with installation.

DIFF= Easy (10)

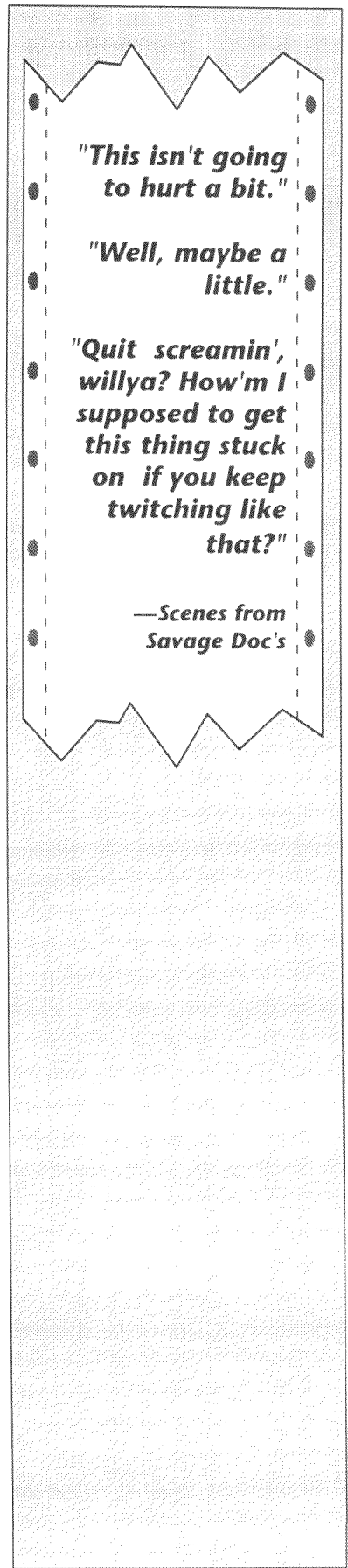

# CYBERWARE LIST

Note: the two letter code following the enhancement is used to identify the enhancement on a character sheet. For example, *Cyberoptic (IE,TA,ME, MV)* would mean a Cyberoptic with Image Enhancement, Targeting Scope, Micro-optics, and Micro-Video recording)

Cyberware	Surg.	ID Code	Description	Cost	H.Loss
<b>FASHIONWARE</b>	—	—	<b>APPEARANCE AND COSMETIC CYBERWARE</b>	—	—
Biomonitor	(N)	(BIO)	+2 to <i>Resist Torture &amp; Drugs</i>	100	1
Skinwatch	(N)	(SWTC)	Subdermal timepiece	50	1
Light Tattoo	(N)	(LT)	Decorative tatoo	1-20	0.5
Shift-tacts	(N)	(SHF)	Color changing contact lenses	1-200	0.5
ChemSkins	(N)	(CSK)	Color/pattern changing skin tints	200	1D6/2
Synthskins	(N)	(SYN)	Color/pattern changing artificial skin	400	1D6
Techhair	(M)	(TEH)	Color/light emitting artificial hair	1-200	2
<b>NEURALWARE (Processor)</b>	<b>(M)</b>	—	<b>BASIC PROCESSOR. MUST HAVE FOR ALL SYSTEMS</b>	<b>1000</b>	<b>1D6</b>
Kerenzikov Boosterware	(N)	(RFB)	Adds +1 to Initiative rolls for every level bought.	500	1D6/2D6
Speedware (Sandevisitan)	(N)	(SW)	Adds +3 to Initiative rolls for 5 turns.	1600	1D6/2
Tactile Boost	(N)	(TB)	Increased sensitivity. +2 on any touch Awareness check.	100	2
Olfactory Boost	(N)	(OLF)	Increase Awareness via smell by +2. Allows scent tracking.	100	2
Pain Editor	(N)	(TE)	Tunes out hot, cold, pain.	200	2D6
Cybermodem Link	(N)	(PE)	Allows direct connection to a cybermodem.	100	1pt
Vehicle Link	(N)	(VLNK)	For direct vehicle operation only.	100	3
Smartgun Link	(N)	(WLNK)	For direct smartweapon operation only.	100	2
Machine/Tech Link	(N)	(MLNK)	Allows control of autofactories, large & small machines.	100	2
DataTerm Link	(N)	(DLNK)	Allows downloading from DataTerms to internal memory.	100	2
Interface plugs	(M)	(PLG)	Allows direct connection to smart weapons, vehicles.	200	1D6/pair
Reflex Chips	—	(APTR)	Chips reflex based skills, Tech Skills requiring manipulation.	varies	0
Memory Chips	—	(MRAM)	Chips INT and other cognitive skills, databases.	varies	0
Chipware Socket	(N)	—	Allows up to 10 chips to be loaded.	200	1D6/2
<b>IMPLANTS</b>	—	—	<b>CYBERWEAR PLACED IN THE BODY</b>	—	—
Nasal Filters	(M)	(NF)	Stops toxic gases, fumes. 70% effective.	60	2
Gills	(MA)	(GL)	Water breathing system, good for 4 hours.	400	3D6
Independent Air Supply	(MA)	(IA)	Good for 25 minutes.	300	2D6
Mr Studd™ Sexual Implant	(MA)	(MS)	All night, every night. And she'll never know.	300	2D6
Contraceptive Implant	(N)	(CI)	Good for 5 years. 98% effective.	100	0.5
SubDermal Pocket	(M)	(PKT)	2"x4" space with Realskinn™ zipper.	200	2D6
Adrenal Booster	(M)	(ADB)	Boosts REF by +1for 1D6+2 turns, 3x per day.	400	2D6
Subdermal Armor	(CR)	(SDA)	Armors torso to SP 18.	1,200	2D6
Motion Detector	(M)	(MD)	Detects motion in a 20sq/m area. 70% effectiveness.	200	2D6
Digital Recorder	(M)	(DGR)	2 hrs storage from any digital source.	200	2pts

Cyberware	Surg.	ID Code	Description	Cost	H.Loss
Audio/Video Tape Recorder	(M)	(AVR)	2 hrs storage from video, audio links.	300	2
Radar Sensor	(M)	(RA)	100m range radar. Must have cyberoptic. 70% effective.	200	2
Sonar Implant	(M)	(SN)	50m range sonar. For water only. 70% effective.	300	2
Radiation Detector	(M)	(RAD)	10m range. 80% detection effectiveness.	200	2
Chemical Analyser	(M)	(CH)	5m range. 70% effectiveness.	200	2
Voice Synthesizer	(M)	(VS)	Can mimic any recorded sound (60%), up to 10 sounds.	600	1D6
AudioVox	(M)	(LS)	Vocal synthesizer for special effects. +2 to Performance.	700	2D6
<b>BIOWARE</b>	—	—	<b>BIOLOGICAL BASED ENHANCEMENTS</b>	—	—
Grafted Muscle	(MA)	(GR)	Up to +2 increase to Body Type	1000/pt	2D6
Muscle and Bone Lace	(N)	(MBL)	Raises Body Type by +2	1,500	1D6/2
Skin Weave	(N)	(SKW)	Armors body to SP 12	2,000	2D6
Enhanced Antibodies	(N)	(EA)	Improve Healing by +1 points per day	3,000	1D6/2
Toxin Binders	(N)	(TBN)	Improve Poison, Drug Saves by +4	3,000	1D6/2
Nanosurgeons	(N)	(NSR)	Doubles healing rate	6,000	1D6/2
<b>CYBERWEAPONS</b>	—	—	<b>IMPLANTED BODY WEAPONS</b>	—	—
Scratchers	(N)	(SCR)	Body Weapon (hands). 1D6/2 damage.	100	2D6
Implanted Fangs (Vampires)	(N)	(VAM)	Body Weapon (mouth). 1D6/3 damage.	200	3D6
Rippers	(M)	(RIP)	Body Weapon (hands). 1D6+3 damage (AP=knife).	400	3D6
Wolvers	(M)	(WLV)	Body Weapon (hands). 3D6 damage (AP=knife).	600	3D6+1
Big Knucks	(M)	(BGN)	Body Weapon (hands). 1D6+2 damage.	500	3D6
Slice N' Dice	(M)	(SND)	Body Weapon (hands). 2D6 damage	700	3D6
Cybersnake	(MA)	(CSN)	Cyberweapon, self controlling. 1D6 damage.	1,200	4D6
<b>CYBEROPTIC</b>	<b>(MA)</b>	—	<b>BASIC EYE MODULE (add up to 4 options per eye)</b>	<b>500ea</b>	<b>2D6each</b>
Color Shift	(N)	(CF)	Allows color changes, special fashion effects.	300	0.5
Image Enhancement	(N)	(IE)	+2 Awareness when using visual search.	300	1
Targeting Scope	(N)	(TA)	+1 on all smartgun attacks.	400	2
Times Square Marquee	(N)	(TS)	LED Screen in vision field for messages.	300	1
Teleoptics	(N)	(TE)	Telescope ability to 20x.	150	0.5
Micro-optics	(N)	(ME)	Microscope.	150	0.5
Anti Dazzle	(N)	(AD)	Immune to flash, laser blinding.	200	0.5
Low Lite™	(N)	(LL)	See in dim light, almost total darkness.	200	0.5
Thermograph sensor	(N)	(TH)	See heat patterns, temperature readings.	200	1
Infrared	(N)	(IR)	See in total darkness, using heat emissions.	200	1
Ultraviolet	(N)	(UV)	See in darkness, using UV flash.	200	1
MicroVideo Optic	(N)	(MV)	Video record up to 20min (takes 2 option spaces).	300	0.5
Digital Camera	(N)	(DC)	Digital Camera, shoots up to 20 images (as 2 options)	300	0.5
Dartgun	(N)	(DE)	Poison weapon (takes 3 option spaces). Holds 1 dart.	200	2



Cyberware	Surg.	ID Code	Description	Cost	H.Loss
<b>CYBERAUDIO</b>	<b>(M)</b>	—	<b>BASIC HEARING MODULE. No option limit.</b>	<b>500</b>	<b>2D6</b>
Amplified Hearing	(N)	(AH)	+1 Awareness when using auditory cues.	200	1
Radio Link	(N)	(RL)	Radio communication up to 1 mile.	100	1
Phone Splice	(N)	(PS)	Full Cellular communication (large city only).	150	1
Scrambler	(N)	(SC)	Cannot overhear communications w/o descrambler.	100	0.5
Bug Detector	(N)	(BD)	Detect taps, bugs up to 3m. 60% effective.	200	0.5
Voice Stress Analyser	(N)	(VSA)	Lie detector. +2 to Human Perception, Interrogation skills.	200	1
Sound Editing	(N)	(SE)	+2 to Awareness to overhear one specific conversation.	150	0.5
Enhanced Hearing Range	(N)	(EH)	Ability to hear supersonic, subsonic ranges.	150	2
Wearman™	(N)	(WM)	Stereo music system.	100	0.5
Radar Detector	(N)	(RD)	Beeps if radar beam is encountered, fixes source (40%).	150	0.5
Homing Tracer	(N)	(HT)	Can follow tracer up to 1km distant.	200	0.5
Tight Beam Radio Link	(N)	(TBR)	Allows untappable radio comm. within line of sight..	200	1
Wide Band Radio Scanner	(N)	(WB)	Will pick up all transmissions on all bands. A scanner.	100	2
Micro-recorder Link	(N)	(MR)	Transmits to recorder in body or via plugs.	100	0.5
Digital Recording Link	(N)	(DR)	Transmits sounds to a digital recorder.	100	0.5
Level Damper	(N)	(LD)	Automatic noise compensation.	300	0.5
<b>CYBERARM</b>	<b>(CR)</b>	—	<b>STANDARD ARM REPLACEMENT (4 options allowed)</b>	<b>3,000</b>	<b>2D6</b>
<b>CYBERLEG</b>	<b>(CR)</b>	—	<b>STANDARD LEG REPLACEMENT (3 options allowed)</b>	<b>2,000</b>	<b>2D6</b>
Quick Change Mount	(N)	(QC)	Allows 1 turn changing of cyberwear.	200	2
Hydraulic Rams	(N)	(HRAM)	Increase limb SDP to 30, 3x normal damages.	200	3
Thickened Myomar	(N)	(THK)	Increase limb SDP to 25, 2x normal damage. +50% on leaps.	250	2
Reinforced Joints	(N)	(RJ)	Increase limb SDP by +5.	200	1
Artificial Shoulder Mount	(CR)	(ASHO)	Mount extra arms (2) below first set. 1 only.	1,500	2D6
Microwave/ EMP Shielding	(N)	(MSR)	Limb is unaffected by Microwave side effects.	300	1
Plastic Covering	(N)	(PSTK)	In colors, transparent, etc.	1-200	1
RealSkinn™	(N)	(REAL)	Limb looks real (DIFFICULT task) Lowers HC by 1D6/2.	200	—
Superchrome®	(N)	(SUPR)	Highgloss metallic covering.	200	3
Armor	(N)	(ARM)	Armors Cyberlimb to SP20.	200	1D6
<b>HANDS &amp; FEET</b>	—	—	<b>ATTACH TO CYBERLIMBS</b>	—	—
Standard Hand	(N)	(STD)	Resembles normal hand	150	0
Ripper Hand	(N)	(RPH)	Standard hand with rippers built in.	600	2D6
HammerHand	(N)	(HAM)	Hydraulic Ram fist does 1D10 damage.	600	2D6
BuzzHand	(N)	(BUZ)	Wire circular saw. 2D6+2 damage, soft armor reduced.	600	2D6
Tool Hand	(N)	(TOL)	Fingers contain screwdriver, wrench, small drill, etc.	200	2
Grapple Hand	(N)	(GRP)	Extends rocket-propelled grapple, 100' line.	350	3
Extension Hand	(N)	(EXT)	Hand extends on collapsable sleeve up to 1m.	350	2



Cyberware	Surg.	ID Code	Description	Cost	H.Loss
Spike Hand	(N)	(SPK)	Palm spike extends thru fingers. 1D6+3 AP damage.	500	2D6
Modular Hand	(N)	(MOD)	Choose any 4 modular tools.	600	2
Standard Foot	(N)	(STDF)	Resembles normal foot.	200	0
Talon Foot	(N)	(TAL)	Extends toe blades. 1D6 damage. (AP=knife)	600	2D6
Tool Foot	(N)	(TOLF)	Toes contain screwdriver, wrench, small drill, etc.	300	2
Web Foot	(N)	(WEB)	Double swimming speed, +3 to swim skill.	500	2
Grip Foot	(N)	(GRPF)	Designed for better gripping strength. +2 to Climb.	500	2
Spike Heel Foot	(N)	(SPKF)	Heel spike for climbing or lethal kicks. 2D6 AP damage.	500	2D6
<b>BUILT INS</b>			<b>BUILT INTO CYBERLIMBS</b>		
AV Tape Recorder	(N)	(AVR2)	2 hour micro cassette storage , needs ext. pickup	250	1
Cybermodem	(N)	(CMD)	Built in "cyberdeck". 5000. <sup>00</sup> for Cellular version.	3000	1
Digital Recorder	(N)	(DGRC)	Digital Chip recorder. Must download or erase chip.	300	1
Storage Space	(N)	(STR)	2"x6" storage space. Can be locked.	50	.5
MiniCam	(N)	(CAM)	Pop up Digital Camera (20 shots).	200	2
MiniVid	(N)	(MVID)	Pop up Mini video (30 minutes).	400	2
Hidden Holster	(N)	(HOL)	Weapon size based on Body Type.	100	1
LCD Screen Readout	(N)	(LCD)	Can be linked to any output device.	200	1
Techscanner	(N)	(TKSN)	Similar to scanner on pg. 59	400	3
<b>CYBERWEAPONS</b>			<b>BUILT INTO CYBERLIMB</b>		
Grenade Launcher	(N)	(GLN)	Weapon. Carries 1 grenade of any type.	500	2D6
Micro-Missile Launcher	(N)	(MML)	Weapon. Fires 4 mini-missiles, 4D6 damage each.	900	2D6
Popup Gun	(N)	(PUG)	Weapon. Size based on Body Type.	2-800	2D6
Flame Thrower	(N)	(FTH)	Weapon. Damage 2D6 1st turn, 1D6/2 2 turns after.	600	2D6
Weapon Mount & Link	(N)	(WML)	Mounting plate plus neural link for 1 weapon.	100	3
2 shot Capacitor Laser	(N)	(LSR)	Shoulder mounted. As a laser, only smaller. 3D6 damage.	800	2D6
<b>LINEAR FRAMES</b>			<b>IMPLANTED EXOSKELETON FOR STRENGTH</b>		
Frame Σ	(MA)	SIGMA	Strength =12	6000	2D6
Frame β	(MA)	BETA	Strength =14	8000	2D6
Frame Ω	(MA)	OMEGA	Strength =16	10,000	3D6
<b>BODY PLATING</b>			<b>EXOARMOR FOR COVERING BODY</b>		
Cowl	(MA)	(SKUL)	Skullcap, covers head in SP 25.	200	1D6
Faceplate	(CR)	(FACE)	Protective facemask. SP 25	400	4D6
Torso Plate	(MA)	(TORS)	Torso protection. SP 25	2000	3D6
Front Optic Mount	(MA)	(FOM)	Allows up to 5 optics to be mounted on face.	1000	4D6
Sense ext. ("Rabbit Ears")	(M)	(RABB)	Head mounted extensors for audio, optics, etc.	500 ea	3D6

"Love your eyes!  
Where'd you buy  
them?"

"Parts N'  
Programms™  
on the lower  
level. They're  
Kiroshis, of  
course."  
—Conversation in  
the Hew Harbor  
Mallplex.

**Minor.**

Required: Medical center or ripperdoc clinic.

Surgical Time: 2 hrs.

Surgical Damage: 1D6+1

Surgical Costs: 500eb

DIFF=Simple (15).

**MAjor.**

Required: Full hospital with surgery center.

Surgical Time: 4 hrs.

Surgical Damage: 2D6+1

Surgical Costs: 1,500eb

DIFF= Trained (20)

**CRITICAL.**

Required: Full hospital with surgery center.

Surgical Time: 6 hrs.

Surgical Damage: 3D6+1

Surgical Costs: 2,500eb

DIFF= Difficult (25)

For more on healing times and surgery and other information, see the *Trauma Team* section, pg. 118.

## Fashionware

While a cyborg is usually defined as anyone who has mechanical technology grafted into his body, the line is actually pretty nebulous (is your girlfriend a cyborg because she wears contact lenses? Is your grandmother a cyborg because she has a hearing aid and an artificial hip joint?). In this hazy zone of cybertech is **fashionware**—little hi-tech gadgets common to the *Cyberpunk* future.

**Biomonitor:** This is a favorite of Solos, gadget freaks, and harried Corporates worried about their blood pressure. Mounted just below the skin of the forearm, the Biomonitor gives a constant readout of pulse, respiration, brainwaves, blood sugar, temperature, and cholesterol levels. The display is a pattern of word-shaped LEDs, each running a color sequence from red (critical) to green (excellent). As conditions change, the colors change. The user merely shoots back his cuff, looks for the little glowing word display he wants, and checks the color. In game terms, this adds +2 to any Resist Torture/Drugs check.

**Skinwatch:** The predecessor of the Biomonitor, the Skinwatch is implanted just below the epidermis, and uses tiny LEDs to project glowing numerals through the skin. Skinwatches can be

mounted anywhere, although the hand, wrist and fingers are the most common. Advanced versions can be reset by pressing the display gently until the right number combinations come up; really advanced versions have alarms that beep quietly. Use your imagination.

**Light Tattoos:** These are light emitting chemical patches inserted under the first couple layers of skin. They store light and emit it in colors or patterns.

**Shift-tacts:** These are colored contact lenses, designed to mimic certain aspects of more expensive cyberoptics. Mirrored contacts in all tints, temperature or emotion sensitive contacts that change color on demand, logo or patterned contacts. These are available in most fashionable bodyware shops. Check it out.

**ChemSkins:** These are special dyes and chemicals which are impregnated or rubbed into the skin. Some change the skin color to a new shade as desired. Others are temperature sensitive, and shift colors in vibrant patterns when warmed or cooled. Very expensive chemskins are sensitive to hormonal changes; you could buy a chemskin that would make yellow and black tiger stripes appear on your skin when you became angry or excited.

**Synthskins:** A more sophisticated version of light tattoo technology, a synthskin is a layer of color-shifting plastic bonded to the character's outer skin. A synthskin can be adjusted to display colors, patterns, light flares or other special effects, using tuning chips (cost 100eb) which are plugged into a socket in the skin (usually under the hairline).

**Techhair:** The shafts of this artificial hair are impregnated with various types of reactive chemicals. Some types are temperature sensitive and change color or stand up depending on the weather. Others contain the same pigments used in light tattoos, storing and emitting colored light in patterns. Still others can change color as desired by using special chemical shampoos. Techhair can be implanted in mohawks, hair weaves, full hairpieces, manes, ruffs, whiskers and other less obvious (but interesting) places.

## Neuralware

One of the most important aspects of cybertech is invisible to the naked eye. This type of enhancement, known as **neuralware**, is usually in the form of tiny co-

processing chips and nerve amplifiers that increase existing abilities.

The basic neural processor is a "switch-box" implanted into the lower spine, and is used to route signals from external cyberwear to the central nervous system. It is the main system for any type of neural interface, including reflex boosters, interface plugs, weapon, DataTerm and vehicle links, mini-computers and sensory augmentations. The Neural processor has a small inspection space which allows secondary co-processors to be inserted into the basic processor module. This makes upgrading a process of opening the inspection space in a sterile environment and inserting the new co-processors.

Implanting a neural processor is far easier than one would expect, thanks to the science of nanotech. The basic module is surgically affixed to the spine, where it releases a flood of nanosurgical units into the spinal column. These microscopic machines thread tiny linkages through the central nervous system, hooking nerve endings to the neural processor. This process takes some time (1D6+7 days) before the nanosurgeons have worked their way through the entire body and all the connections are hooked up to the neural processor.

### Coprocessors

These are specialized "add-ons" which can be plugged into the main neural processor at any time; the whole process takes about an hour and can be performed in any walk-in clinic. Some, like reflex boosters, allow you to improve your reactions and perceptive abilities to inhuman levels; others, like link co-processors, allow you to interface with computers, databases, vehicles and other machines. Once you have the basic neural processor, you can jack in as many options as you like.

**Reflex Boosters:** These are specialized TRC coprocessors that amplify and speed up signal processing. The biggest advantage to a REFLEX boost is its ability to increase a character's initiative rolls in combat. There are two types of Reflex co-processors (also known as *boosterware*). Note: this is the only type of boost which can be used with the *Boostmaster* enhancement

in *Solo of Fortune*. You may only select *one* type of boosterware (and you may not combine multiples of a single type of boost).

**Kerenzikov** boosterware is always activated; the character is always reacting with a higher than normal reaction speed. Since Kerenzikov often boosts responses to greater than 10, it has a high humanity cost, as the user must learn to readjust his or her actions to a world that appears to be moving in slow motion. Because of this, Kerenzikov boost can be installed at two levels of augmentation (+1 or +2 to Initiative, HL is 1D6 or 2D6).

**Speedware** (also known as Sandevistan) kicks in only when desired, eliminating much of the need to adapt one's entire life to an inhumanly fast reaction time. The character must first subvocalize a mental command word before boost is activated, then wait one turn before the boost kicks in. He will remain boosted for five full turns (+3 to Initiative rolls) before the boost cuts out. He must then subvocalize the command again, and wait 2 turns before regaining a boosted state.

Speedware's big advantages are in lower humanity costs and improved performance; because the body isn't "on" all the time, more can be drawn from it during the boost mode.

**Tactile Boost:** This increases any Awareness roll involving touch by +2. The boost can be turned on or off at will, taking one turn to do so.

**Pain Editor:** This coprocessor overrides the pain receptors of the brain, making the subject impervious to torture, deprivation or physical hardship. It doesn't mean he isn't getting hurt, just that he won't notice it until he collapses (make Endurance Skill checks, but at two levels of difficulty lower than normal)

**Olfactory Boost:** This increases any Awareness roll involving smell by +2. In addition, the subject adds +2 to his Shadow/Track skills (he can track by smell), and has a 50% chance of locating a scent to begin tracking with unless the target has taken particular pains to disguise its scent). The boost can be turned on or off at will, taking one turn to do so.

**Links:** Links are specialized co-processors that allow you to translate signals from the device you want to run into your neural code. There are five major types of link; you must have the proper link in order to run that type of device.

**Cybermodem Link:** This is the basic proces-

*"Let me give you an idea of how fast boosterware is. There was a guy in the 102nd Cybercav back in Panama City. One night, we were all real high on something—must have been 'Lace—and some flathead fired off a round. This guy actually—believe it or not—caught the round in his hand—a one in a million chance, sure, but he did it."*

*Of course, it blew his hand right off. But the way he figured it, he could always buy a new hand, and he'd be gettin' drinks off that story for the next ten years..."*

—Morgan Blackhand

### How a Smartgun Works:

- 1) Smartgun has laser sight mounted on top. Laser sight sends signal via plugs to link when target is in sights.
- 2) Link translates signal and sends it to processor.
- 3) Processor detects "fire" reflex in your body, triggers gun via link and plugs.
- 4) Gun fires.
- 5) If cyberoptic is present, it sets up a crosshair sight on the target. When gun's laser sight matches targeting crosshairs, gun fires.

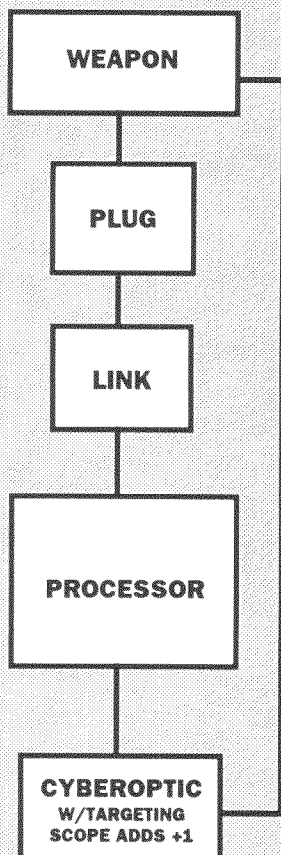

sor that translates Net information into images. It replaces the more limited interface programs of the early 'teens, and allows the Netrunner to perceive a wider variety of environments than its predecessors.

**Vehicle Link:** This allows the user to control a vehicle through direct mental control. Cybervehicles include cars, AV-4s, aircraft, rotorcraft or motorcycles which have had their normal control systems replaced by a computer. The character plugs directly into the computer using interface plugs and cables, sending commands thru his own nervous system. Power servos then steer wheels, depress accelerators, and control braking. Cybervehicles are inhumanly responsive—like driving an extension of yourself. As a result, a cyberassisted vehicle will automatically give you a +2 on any driving, piloting or motorcycle driving skill you are using at the time. To modify a normal vehicle to cybervehicle stats costs an additional 40% of the base vehicle cost.

**Smartgun Link:** Smartguns are modified versions of normal firearms, linked to an internal microcomputer, which in turn is jacked to a human operator. A smartgun uses a small sonic or laser projector to lock onto the target, scanning it thousands of times per second. As the gun traverses the desired target, the computer link picks up your mental fire signal (or incoming data from the targeting reticule of your cyberoptic) and triggers the gun. Smartguns are far more accurate than most other guns; using them automatically gives you a +2 to any firearms attack you are making. The cost of adapting a normal gun to smartgun configuration is twice the normal cost of the gun.

**Machine/Tech Link:** This allows the user to interface with (and control) any autofactory or heavy machine operating from a MLINK-based control system. You can also control small machines/appliances in non-factory situations.

**DataTerm Link:** This co-processor allows the user to directly access and store information from a DataTerm, transferring it to a Times Square Marquee, or a LCD screen for display (in game terms, this allows the character to access information as if a DataTerm were available, even if it isn't)

**Interface Plugs:** These are the staple of Cyberpunk culture. Usually installed in the bones of the wrist, spine or skull, they tap into major nerve trunks and interface with the neural proc-

essor to send and receive signals. The plug itself can be used to insert information and reflex "skill chips", or as a plug in for a set of interface cables (allowing you to directly control any device you have the proper "link" with). In game terms, interface plugs allow the player to directly link to many types of machines, such as cybermodems or cybervehicles.

Interface plugs are quite common; many companies will even pay for their installation. Quite a few factory and construction workers now "stud" directly into their machines. Interface plugs are critical to people like Netrunners (who must have them to gain the speed and ability to run the Net), and Solos (who use them to operate smartguns).

Most people wear their plugs on wrists for ease of use. Occasionally, a true cybertechie will mount them at the temples (a plug head), just behind the ears (called a frankenstein) or in the back of the head (a puppethead). Some cover them with inlaid silver or gold caps, others with wristwarmers. Once again, a matter of style.

### Chipware

There are a wide variety of cybernetic devices available to the man on the move in the 2000's. But the basis for all these newtechs is chipware (also known as wetware by some), bio-plastic circuitry that allows the human body to mesh with the power of silicon microprocessors.

There are two types of chipware; **reflex (APTR) chips** and **memoryware (MRAM) chips**. Each piece of chipware operates exactly like the skill of the same name. To use chips requires two separate installations: a neural processor located at the base of the spine, which translates the chip data into useful information, and a set of interface plugs or chipware sockets.

The chip itself is a small, transparent sliver about an inch long, often color-coded for identification. It is inserted into the interface plug point down. It takes one turn to change chips. You may "run" as many separate chip programs at one time as your current INT stat.

*Example: My INT is 7. This means I can have up to seven different program chips operating at one time. I could be chipped for Karate, AV-4 Piloting, Pistol, Assault Weapons, AV-4 repair, Play Instrument and Specific Knowl-*

edge: *Rock Songs of the 1960s*. However, I could not use any other chips until I'd removed one of these seven.

Having chipware is like having instant skills whenever you want them. The problem is, chipware is expensive, and limited to only the lowest levels of a specific skill (from +1 to +3). To progress further, you would have to have a specially designed chip built at a higher level (not an easy proposition). A natural skill, on the other hand, progresses by use and this increase in ability costs nothing except time.

Another problem with chips is that unlike natural skills, you can't learn to become better. If you're chipped for a *Karate* of +2, you'll be at that level of skill until you die, no matter how many fights you get into. You also can't combine natural and chipwared skills; for example, combining a chipped *Karate* of +2 and a natural *Karate* skill of +5 for a total of +7. The programmed responses of a chip will always override natural responses, setting the user's level of skill equal to that of the chip.

Chips are best used when you need to know a lot of things all at once, but not very well. With chips, you can become a limited martial artist, pilot, driver, marksman. You can know a little bit more than you did before about a variety of subjects, but nowhere near as much as you would if you'd hit the books and studied.

**Reflex (APTR) Chips:** These are chips for Reflex-based skills only, such as weapon firing or hand-to-hand combat knowledge. These Augmented Programm TRCs feedloop —record a specific neural signal from one source, record it in memory, then use the recording to activate a series of muscle reactions in another source. Theoretically, these chips should allow even the lowliest "grunt" to have the skills of a karate master, the shooting ability of Wyatt Earp, and the reflexes of an Olympic athlete. But the limits

of programming restrict what you can learn from a chip to a relatively low level (about +1 to +3).

In addition, a Reflex chip must adapt to your specific neural and muscular patterns, adjusting its instructions to fit your body and vice versa (after all, the karate master who was the pattern for the chip might have been five foot ten and you might be six foot three). It learns your body movements by sampling your responses as you practice using the chip. This process is known as chipping in and is required before the chip can be fully functional.

Chipping in takes two full days of practice for every level of the chip. This means, for example, if you've been chipped for *Martial Arts* +3, it will take six days of practice before the chip has "learned" enough about your body to be fully functional. If you only get two days of practice, the chip will function as a level +1 — practice for four days, and it's raised to +2.

### Memory (MRAM) Chips:

These are chips for information only, used for storage of raw data on a specific subject. A memory chip operates just like a skill of the same type, is rated from +1 to +3, and is applied to the same stat as the original skill (for example, *AV-4 Tech*

would be combined with your TECH stat, while a *Language* chip would relate to your INT stat). MRAM chips do not require a previous knowledge of the skill involved and have no chipping-in time.

**Chipware Socket:** A small socket used only for inserting chipware (see above). With a chipwear socket, you can use your interface plugs to control other things (such as weapons or vehicles), while still having access to MRAM and APTR information. Holds 10 chips.

## Implants

Implants are the useful little things you get plugged in to make living easier; things that you can't replace from a Body Bank, or that you may want for a specific job. Note: Motion detectors, radiation detectors, and chemical analysers are 360° systems. Radars/Sonars are 180° systems.

## CHIPS & PRICES

Type	Price Per Level
<b>ATTR (MRAM)</b>	
Personal Grooming .....	100
Wardrobe & Style .....	100
<b>BODY (APTR)</b>	
Swimming .....	100
<b>INT (MRAM)</b>	
Accounting .....	150
Anthropology .....	150
Biology .....	150
Botany .....	150
Chemistry .....	150
Education & Gen.Know .....	200
Expert (pick subject)	
..... Ref Decision	
Geology .....	150
History .....	150
Know Language (choose) .....	200
Mathematics .....	200
Physics .....	200
Programming .....	300
Stock Market .....	300
Wilderness Survival .....	200
Zoology .....	150
Daytimer Chip .....	100
<b>REF (APTR)</b>	
Archery .....	300
Dance .....	150
Driving .....	150
Fencing .....	300
Handgun .....	300
Heavy Weapons .....	400
Martial Art (choose type) .....	350
Melee .....	150
Motorcycle .....	150
Operate Hvy. Machinery .....	200
Pilot (Gyro) .....	300
Pilot (Fixed Wing) .....	300
Pilot (Dirigible) .....	300
Pilot (Vect.ThrustVehicle) .....	350
Rifle .....	300
Submachinegun .....	300
<b>TECH (APTR)</b>	
Aero Tech .....	250
AV Tech .....	300
Basic Tech .....	200
Cryotank Operation .....	150
Cyberdeck Design .....	200
CyberTech .....	300
Demolitions .....	300
Disguise .....	150
Electronics .....	150
Elect. Security .....	200
First Aid .....	150
Forgery .....	200
Gyro Tech .....	300
Pharmaceuticals .....	200
Pick Lock .....	150
Pick Pocket .....	150
Play Instrument .....	150
Weaponsmith .....	200





**Nasal Filters:** These filters increase Saves against poison, sleepdrugs or other breathable toxins by +4.

**Gill Implant:** This implant allows the user to breath relatively clean water (saves vs. poison must be made if the water source is polluted or contains toxic chemicals) for up to 4 hours.

**Independent Air Supply:** A small artificial organ, filled with a spongy, oxygen fixing foam. Implanted in the lower lungs, it allows an inactive character to hold his breath for up to 25 minutes, or an active character up to 10 minutes.

**Mr. Studd™ Sexual Implant:** All night, every night, and she'll never know. Use your imagination and add +1 to your Seduction checks. Available also in the *Midnight Lady* version for the distaff side.

**Contraceptive Implant:** Implanted under the left armpit, it prevents pregnancy for up to five years. Available for both sexes.

**Subdermal Pocket:** 2" x 4" plastic pocket hidden under the skin, with a pressure sensitive seal. Useful for couriers. Detection requires a DIFFICULT Awareness check.

**Adrenal Booster:** An artificial gland which releases adrenal hormones on command. Adds +1 to REF for up to 1D6+2 turns, three times per day.

**Subdermal Armor:** This is a mesh/ballistic plastic armor inserted under the skin. To detect subdermal armor requires a DIFFICULT

Awareness roll. Subdermal armor covers the torso only.

**Motion Detector:** Detects motion (direction and strength) in a 20 sq.m area with a 70% effectiveness. Can be mounted in the palm or heel.

**Digital Recorder:** This unit can record input from internal microphones, from a digital recording link, a digital camera, or all three. The unit is stored in its own subdermal pouch, and can record up to 2 hours of information on each chip.

**Audio/Video Tape Recorder:** This unit uses microcassettes to store input from its internal microphone, video cam or digital recording link. It is stored in its own subdermal pouch for easy access. Each cassette holds 2 hours of information.

**Radar Sensor:** 100m range radar unit implanted in shoulder, with emitter in skull. Implant causes visible bulge in forehead.

**Sonar Implant:** 50m range sonar unit implanted in skull.

**Radiation Detector:** 10m range, 80% detection effectiveness. Can be implanted in any body area, with a beep alarm mounted on the mastoid bone.

**Chemical Analyser:** This modification to the nasal passages analyses smells and breaks them down to their chemical components. The re-

sults can be output to an LCD screen, Biomonitor or Times Square marquee.

**Voice Synthesizer:** This system allows the user to mimic any voice or tone previously recorded by it's memory chip. The chip can store up to 10 "voices". This system also gives the user a +4 to any Disguise attempt (now you really sound like the person you're imitating).

**AudioVox:** This system allows the user to control vocal tones, volume and tone quality with the precision of a musical synthesizer. Special effects (reverb, tremolo, sustain and choral voices), loudspeaker volumes and vocal delay programming (for singing with yourself) are also possible. This effect adds +2 to any vocal Performance Skill check.

## Bioware

Bioware is anything which is primarily low-impact technology that is designed along biological rather than mechanical lines.

Most bioware enhancements involve the use of *nanotechnology*; tiny machines the size of microbes, which can perform surgical tasks on the cellular level. These "nanoids" are injected into the area to be affected, along with a supply of the raw materials needed to perform their jobs (for example, long string polymers which can be woven by the nanoids into a type of subdermal armor called skinweave). Powered by body heat and nutrient chemicals, these tiny machines quietly go about their business, strengthening muscles and altering body chemistry.

**Grafted Muscle:** This is vat-grown muscle grafted onto your own, with healing. With this modification, you may increase your Body Type stat up to 2 points, paying 1000 eb per point. It can be combined with Muscle/Bone Lace.

**Muscle & Bone Lace:** Also known as *viral transformation*, this enhancement involves two types of nanoids. The first type threads synthetic muscle through the natural muscle fibers, anchoring and strengthening them. The second type wraps the bones in a light weave of metal and plastic threads, making them stronger and thicker. The result is an increase of +2 to the character's Body Type stat. This increase is both in strength and the ability to absorb physical

damage. This enhancement is virtually indestructible and takes about two weeks (Body Type increases by 1 each week).

**Skin Weave:** This enhancement uses nanoids to weave the top three layers of skin with a dense polymer thread. The result is a bare skin SP of 12, equivalent to light body armor. The process is relatively discreet (a DIFFICULT Awareness check to notice), and takes about two weeks (SP increases by 6 each week).

**Enhanced Antibodies:** These are tailored antibodies capable of attacking the most powerful

**" So I went into the Clinic for the treatment. They jammed an IV into my arm, and made me drink a lot of horrible concoctions. A week went by. I was working on the dock when a pallet broke loose and trapped the foreman. I walked over, grabbed, and lifted the pallet off him. A quarter ton. Frack. This nanotech stuff is scary!"**

viruses. In game play, they double the rate of healing.

**Toxin Binders:** These are nanoids designed to bond with body toxins and poisons. This enhancement adds +4 to all poison saves.

**Nanosurgeons:** These are microscopic machines adapted to surgical repair. Some seal off damaged blood vessels, while others repair damaged tissue, cartilage and bone with polymer microstiches. This enhancement doubles normal healing time.

## Cyberweapons

At the top of the Black Cyberware hit list are cyberweapons; hidden killing tools that can be buried in your skin until the moment you want to take someone out. Cyberweapons are normally not available on the open market (the only exception are scratchers and vampires), and locating them usually involves going down into the local Combat Zone, finding a Fixer, and paying a lot of euro to ugly, nasty, violent people who would normally consider you spare parts.

Boosters, of course, are drawn to cyberweapons like a 'zoner to zoom dust.

**Scratchers:** Implanted metal or carbo-glas fingernails. The incredible sharpness of the mate-

*"Rippers.  
Vampires. Skin  
grafts.  
Sometimes I  
think we've got  
a population  
explosion of  
werewolves on  
our hands..."*

*—Lt. "Strawberry"  
Morressey, NCPD*

*"Werewolves.  
Whoa, whatta  
great idea. I  
gotta work on  
that..."*

*—Ripperjack*

rial makes these as deadly as razor blades (1D6/2 per hand damage). Scratchers cut on the bias, requiring the user to slice crossways, not rip downwards. Most people lacquer their scratchers, making them indistinguishable from normal nails (the enamel has no effect on the sharpness). These are not considered lethal (and therefore black market) cyberwear, and can be purchased in any local clinic.

**Vampires:** Implanted fangs, usually made up of carbo-glas or superchromed metal. You can have a full set implanted (called the Sharkgrin Special, it causes 1D6/2 in bite damage), or canines only (1D6/3 damage). These are considered to be "decorative," not black market cyberwear, and can be purchased in any local clinic. Vampires can be augmented with poison injectors (which are black cyberware) for double the normal price.

**Rippers:** Longer, heavier versions of scratchers (1D6+3 per hand damage). The top two joints of each finger are replaced with a plastic and metal sheath, in which three inch carbo-glas claws are housed. The rippers can be extended by clawing the hand in a catlike fashion. Most people wear false fingernails over their rippers, making them much harder to spot (a DIFF task). Rippers are considered a form of black market cybertech and as such is not accessible through the average on-the-Mall clinic. Rippers cut in all directions, and are considered Edged weapons for AP purposes.

**Wolvers:** The longest and deadliest of the implant blades, wolvers are implanted along the back of the hand. When the hand is clenched in a fist, the thin, triangular blades telescope and lock into place, remaining extended a full foot until the hand is relaxed. Damage is 3D6/hand. Treat as Edged weapons for AP purposes.

**BigKnucks:** Reinforced knucklebones, giving the fist the impact value of a pair of brass knuckles (1D6 +2). This is considered a form of black market cybertech, and as such is not accessible through the average on-the-Mall clinic.

**Slice N' Dice:** Mono-filament wire spool mounted in end of one finger, with a weighted, false fingernail to give it balance and swing. Monomolecular wire will cut through almost any organic material and most plastics. Can be used as a garrotte, cutter or slicewhip. This is considered a form of black market cybertech, and as such is not accessible through the average on-the-Mall clinic.

**Cybersnake:** This is a simpler version of the cybersnake found in the *Hardwired* supplement.

This version has far less features and is limited to making a rake attack only. The rake has a range of 1 meter and inflicts 1D6 in damage each time it hits. The cybersnake may be mounted in any body orifice 1" or larger, or may be implanted in the shoulders using a special mount.

## Cyberoptics

A combination of digital processor and camera, cyberoptics are replacements for normal eyes. Cybervision is just like regular vision, only better. Colors are brighter, images sharper. And that's just the start.

Want to see life as a 30's black and white movie? No problem. Telescopic or microscopic vision? Optional. Infrared and low light vision? Standard for Solos.

Cyberoptics can look exactly like normal eyes, although a wide variety of fashion iris colors are available (amber, white, burgundy and violet are very popular). Some versions are transparent, with glitter or lights swirling inside of them. Other are superchromed for a more "cyber" look. Others can change eye color at will or to match clothes and surroundings. Some even have tiny designer logos around the iris. Cyberoptics with cameras or weapons usually load from the front, with the iris opening up when the front of the eye is depressed.

**Color Shift:** These cyberoptics can shift color or iris pattern on demand. A full color shift takes about a minute. Mirrored, transparent, glitter-filled or lighted versions are also available.

**Infrared:** Allows user to see in near total darkness, using heat emissions for image reception.

**Times Square™ Marquee:** Scrolling red-letter screen in upper edge of vision, linked to either a software chip readout or a radio link.

**Targeting Scope:** This projects a targeting sight into the field of vision at will. The targeting scope will read range to specific objects, speed of movement, bearing and size, as well as providing several types of scope reticle for aligning weapons. When chipped into a smartgun, the scope will match the targeting sensors of the gun with what you are looking at, then flash a "ready signal" when the target is acquired. In game terms, this option allows you to add +1 *only* to smartgun attacks.

**Anti-dazzle protection:** Auto stepdown compensates for harsh sunlight, flares, etc., neutralizing effects from strobes, flashbombs and bright headlights. Never need sunglasses again.

**Low-Lite™:** Allows user to see clearly in dim light conditions, down to very faint moonlight or distant streetlamps.

**Image Enhancement:** High-res graphics capability allows user to enhance and refine images viewed. When activated, increases Awareness skill by +2, allowing user to pick up visual cues in greater detail.

**Thermograph Sensor:** Allows user to see heat patterns of objects, people. Cooler things show up as dark to light blue, hotter things as red or orange, and the hottest of all as yellow or white. Used to distinguish differing heat sources through light structural material, or the presence of cybernetics (which are always cooler than normal body temperatures). Can also determine the operating time of certain machinery by measuring its cooling gradient.

**Dartgun:** One shot dartgun. Range of 1 meter, +2 WA. Poison dart will penetrate up to SP6 automatically, SP8 50% chance, soft armors only. Takes 3 spaces.

**Micro-Optics:** This is the equivalent of a laboratory microscope, allowing the user to see microscopic images, such as fingerprints, scratches on locks, etc.

**Teleoptics:** This is the equivalent of a 20x power telescope, allowing the user to see distant objects clearly.

**Ultra Violet:** This system allows the user to perceive images irradiated by ultraviolet light, or to detect florescent powders or tracing agents, or to use ultraviolet flashlights (undetectable by normal optics) for illumination.

**MicroVideo:** This is a cyberoptic mounted video camera which records its view on an internal video tape (20min). This recorder can also be downloaded through interface plugs to an external source. Takes up two option spaces.

**Digital Camera:** This cyberoptic mounted camera takes up two option spaces. Up to 20 images can be recorded on the built-in digital chip and downloaded through interface cables to an external recorder, internal recorder, or an

internal LCD screen. As new pictures are taken, the previous ones are erased.

## Cyberaudio

Cyberaudio systems patch into the auditory nerves and speech centers of the brain. This enhancement affects both ears, and also includes a subvocalizing mike on the mastoid bone. There is no visible change to the outer ear, although some cyberpunks replace the outer ear with a set of mechanical speaker pickups for max effect.

**Radio Link:** A microminiature radio transceiver, usually mounted at the base of the skull and using your fillings as the antennae. It is activated by clicking the teeth together sharply. To talk, you merely subvocalize (mutter under your breath). Reception is carried out in one of two ways: 1) a receiver directly vibrates the mastoid bone, giving you a small tinny voice in the back of your head, or 2) linked to a cyberoptics Marquee option, incoming messages are

flashed into the upper edge of your field of vision as red scrolling letters. In game terms, having a radio implant gives you the ability to talk to any receiver on the same band frequency for up to 1 mile. It also means you occasionally get someone else's radio messages.

**Phone Splice:** An improved radio splice, this implant is wired to communicate directly to your personal cellular phone. In practice, it allows you to do everything the radio splice does, but you must have your phone within 3 meters of you, and it must already be turned on and the number dialed. Audio splice is commonly used by busy Corporates who want to be able to answer calls, even in a meeting. One of the biggest advantages of audio splice is it's range—anywhere your phone will go, you can go. Even the Moon.

**ECM Scrambler:** This implant improves your radio or audio splice with a scrambler, so it cannot be listened into. In game terms, this makes all radio or audiosplice communications private, unless the interceptor has a descrambler unit and a lot of time on his hands.

**Bug Detector:** This mini-receiver is designed to pick up signals transmitted by all types of radio bugs. When the bug is active, its transmissions

***"The worst part of cyberaudio is when you hear what you really wish you hadn't. I used to be a whole lot less cynical before I got my Kiroshiis"***  
—Kestral

***"I can see for miles and miles and miles and miles..."***

—The Who

***"Hear me...See me... Touch me...Kill me..."***

—Sarah O' Connor  
***Tribute to Tommy,***  
2019

*"It's one thing to smell the fear on your opponent's skin. But it's another to get a four-color digital readout of his terror; a full spectrum recording of his lies and evasions as he desperately tries to save his life..."*

—Morgan Blackhand

*"In the Future, there's no place to hide from yourself..."*

—Lyle McClellan,  
Network 54

make a small beeping noise in the back of your head, getting louder as you get closer to the bug. In game terms, this gives you a 6 out of 10 chance (roll 1D10, choose your six numbers) of detecting any bugs within 10 feet of you. A normal option for Corporates, Fixers and Solos.

**WearMan™:** A variant of the radio splice, the WearMan mounts twin vibration speakers on your mastoid bones, making your skull into a audio system of concert hall quality. A tiny chip mount wired into the earlobe allows you to plug in a variety of music chips, all fashioned to look like earrings. Or you can plug in direct to your interface plugs. Each chip contains about 100 songs. Selections are fast-forwarded by squeezing the earring gently, once per selection. When the chip is removed, the WearMan turns off. A teenybop fave.

**Amplified Hearing:** This system improves hearing and sound recognition ability, adding +1 to any sound-related Awareness check.

**Voice Stress Analyser:** This system acts as a lie detector, detecting minute changes in vocal patterns and tones and comparing these to a pre-recorded set of parameters. You must first use the analyser on the subject while he/she is in an unstressed situation or is telling the truth. All subsequent tests will give you a +2 to Human Perception or Interrogation skill checks on that particular subject.

**Sound Editing:** This system allows the user to edit out distracting noises or "zero in" on a particular sound. Activation of this system adds +2 to any sound-related Awareness check. Sound editing can be used in conjunction with Amplified Hearing or Enhanced Hearing.

**Enhanced Hearing Range:** This subsystem allows the user to hear tones in the subsonic and supersonic ranges.

**Radar Detector:** This system produces a loud beep whenever a radar beam is encountered. It also has a 40% chance of triangulating the source; when the direction of the beam is determined, the beep changes to a clear tone.

**Homing Tracer:** This option allows the character to follow a homing tone broadcast from an external sender. Range is 1 km. The tone increases in volume as the user gets closer to his target. The homing tracer comes with two senders, about the size and shape of a pin. Extra senders cost 25seb. each.

**Tight Beam Radio Link:** This option allows tight beam radio communication for up to 1 mile, as

long as both parties are within line of sight to each other and not blocked by any object thicker than 1 foot.

**Wide Band Radio Scanner:** This option automatically scans all major police, fire, ambulance, and Trauma Team communication bands. The user can set this scanner to cover one specific band, downloading any incoming messages to his own internal radio link or Times Square marquee.

**Micro-recorder Link:** Downloads anything heard by the user to either an internal or external (via interface plugs) sound recorder.

**Digital Recording Link:** This option allows anything heard by the user to be recorded on an internal microchip (2hrs). Recordings can be downloaded to an internal recorder or via interface plugs to an external recorder.

**Level Damper:** This system automatically compensates for loud noises, such as stun-bomb attacks or sonic weapons. Characters with this option can ignore all effects of these weapons.

## Cyberlimbs

When the man on the Street thinks of cyborgs, what he thinks of are artificial limbs; whirring, glittering metal constructs of steel, wire and microchip circuitry. Although real arms, legs, and organs can easily be grown in bio-tanks or replaced from body banks at a much lower cost, artificial limbs are still a popular fad of the Cyberpunk future. They are chromed, airbrushed, jeweled, lighted, and even sculpted in the pursuit of true cybertech chic.

Under all the designer fashion, the standard cyberlimb is an aluminum and steel basket framework, with artificial myomar plastic muscles controlling motion. The joints are stainless steel. The cyberlimb plugs into a special nerve interface jack mounted in the flesh above the limb, while the main unit is coupled to a metal and plastic cuff around the meat part of the limb. The cuff is usually placed at the upper bicep/thigh or the elbow/knee, however, arms may also be attached to an artificial shoulder (see below), and anchored to an external arm mount.

### Cyberlimb Myths & Abilities

The popular myth about cyberlimbs is that they enable their owners to perform all



kinds of superheroic feats. To a point, it's true; cyberlimbs can be designed with boosted strength and speed, using synthetic muscle fibers and silicon chips. What you won't find are people running at 200 miles an hour, bending steel bars with their hands or throwing Volkswagens around. Why can't you go around lifting cars and punching down walls like the cyborgs in the comics? Simple physiology. The replacement limb must be able to work in concert with the remaining "meat" parts of the body. Even if your arm was ten times stronger than before, the back and shoulder muscles supporting that cyberlimb wouldn't be—and they'd shred long before the artificial muscles did. But within limits, a cyber-equipped person can do some pretty impressive party tricks:

**Crushing:** A cybernetic arm uses synthetic muscle fibres instead of flesh and blood. They don't get tired, and they don't feel pain. They are also much stronger than normal muscle tissue. This gives a cyberarm tremendous gripping power. All cyberlimbs can easily crush light metals, woods and plastics. They can crush glass and plastic to dust (although they can't crush lumps of coal into diamonds!). In combat, any crushing grip with a cyberarm will do 2D6 damage.

**Pain:** Cyberarms never grow tired, allowing the wearer to hang from high places indefinitely. You can turn off the touch sensors with the flick of a mental switch, eliminating pain and allowing you to perform feats such as reaching into raging fires, dabbling in tanks of liquid nitrogen, and picking up red-hot pokers. A gunshot wound to a cyberlimb has no pain effects; you don't have to make a saving roll against shock and stun.

**Damage:** Cyberlimbs can take (and dish out) a tremendous amount of damage, so much so that they are treated like machinery for the purposes of game combat. All cyberlimbs can take up to 20 points of structural damage before they are useless, and up to 30 total points of structural damage before they are destroyed. A cyberarm punch does 1D6 damage to its target; wall, car, someone's head; no matter. A cyberleg kick will do 2D6 damage.

**Leaping:** Cyberlegs employ powerful pistons and microsensors, backed by bundles of synthetic muscles. With a pair of them, you can leap tremendous distances. Characters with paired cyberlegs can leap 6 meters straight up, or make a running jump of up to 8 meters.

### Options

These are things which can be done to a basic cyberlimb to improve its strength, damage capacity, or flexibility. In addition to these improvements, artificial shoulders can be mounted at waist level to provide extra arms. A cyberlimb can hold up to 4 options or built-ins. A hand or foot is considered to be one option. (Cyberlimbs automatically come with basic foot modules.)

**Quick-change mounts:** These allow the user to change cyberlimbs without using tools. The limb is bayonet mounted, and can be removed by depressing a thumb catch and twisting to the left. Quick-change mounts may also be used at the wrist or ankle joints to allow a variety of hands or feet to be used. To calculate HL, average the HC's of all the options you're using with the mount, then double it.

**Hydraulic rams:** Common to Soviet cyberwear, rams are bulkier and heavier than myomar fibers (the limb will not pass inspection as real no matter how well covered by Realskinn™), but can take more damage (30 SDP to disable, 40 to destroy). Limb strength is also increased (3x crush, punch, and kicking damage).

**Thickened myomar strands:** These give limbs greater strength (2x normal damages) and durability (+5 SDP). Leaps are increased by 50%.

**Reinforced joints:** These are made of titanium steel instead of stainless, and add +5 SDP to the cyberlimb.

**Artificial shoulders:** These are swivel joints which can be mounted to a back mounted frame. This allows up to two extra arms to be mounted at waist level. The unit has an SDP of 25.

**Microwave & EMP shielding:** Protects your cyberlimb from electromagnetic pulse and microwave attacks. Shielding may be placed on any type of limb no matter what covering is used; it is placed internally, using up one space in the limb.

**Coverings:** While all cyberlimbs come in a stripped or uncovered state, they can be covered in a variety of ways. The cheapest method is a plastic covering, available in a variety of

*"So I kicked off th' roof and jumped the gap between rooftops. Whammo. My right cyberleg punched through the cheap 'crete as I hit the other side. Reached out and grabbed a big pipe to keep from fallin', and my cyberhand crushed it into a metal pretzel...Just wasn't my night..."*

*—Ripperjack*

*"Two optional hands, including a tool model. Cybermodem up the bicep, with a popup 9 mm. Jeeze. Guy's left arm looks like a frackin' Swiss Army knife..."*

*"Shaddup and help me loot the body, Ripper."*

*—Ripperjack*

colors, with airbrushing, or transparent with imbedded lights and holography. A plastic covering may also be chromed (a popular option), or covered with a metallic skin tinted in golds, blues, greens, reds or silvers. The most expensive option is Realskinn™, a flexible plastic that looks very much like skin; with follicles, hairs, small scars and imperfections, it has a 75% chance of passing as a "meat" limb to all but the closest inspection.

In lieu of a covering, the cyberlimb can be armored with Kevlar and ballistic plastic. This armor covering protects the limb with an SP of 20. However, you may not cover or chrome an armored limb.

### Hands & Feet

The basic cyberlimb comes without hands or feet attached; these are purchased separately, allowing the user to tailor the limb to his or her specific needs. These parts can be changed by unfastening a series of connection bolts, and reconnecting the new hand or foot (taking about four turns).

No, you can't put hands on legs and vice versa. Get a life.

**Standard Hand:** This resembles a normal hand; four fingers and a thumb. The hand is covered, superchromed or armored as part of the arm.

**Ripper Hand:** This is a normal hand with ripper blades mounted in the upper hand and wrist area.

**Hammer Hand:** This hand is made of hardened titanium and has a powerful explosive shell-driven ram that acts like a jackhammer. You punch, the shell goes off, driving the fist forward with incredible velocity and power (1D10 damage). A port in the top ejects the shell and opens to receive a new one (replacements cost 3eb).

**Buzz Hand:** This hand can be pulled back to reveal small, spinning mono-wires around a titanium hub. The high speed "weed wacker" shears through most materials like butter. Damage is 2D6+2, soft armors reduced 2 pts./hit.

**Tool Hand:** This hand's four fingers conceal small microtools: 1) screwdriver with changeable heads, 2) adjustable wrench, 3) battery-powered soldiering iron, 4) adjustable socket wrench. The lower edge of the palm is hardened to make a dandy hammer.

**Grapple Hand:** This hand's fingers extend backwards to create a five fingered throwing grapple. A small spool in the wrist contains 30 meters of fine, super strong line capable of supporting 200 lbs.

**Extension Hand:** This hand can extend from a telescoping wrist mount up to 1 meter. Can support up to 200 lbs.

**Spike Hand:** This hand contains a hardened titanium spike which telescopes out of the wrist and through the lower palm. Can be Poisoned and is useful for climbing. Damage is 1D6+3 AP.

**Modular Hand:** This unit contains 1) Drug injector, 2) 1 meter garotte line extending out of fingertip, 3) One-inch monomolecular blade for cutting, 4) Picklock. In addition, there is a 2"x2" Palm Storage Space.

**Talon Foot:** This foot can extend narrow blades similar to scratchers for 1D6 damage. Treat as Edged weapon for AP damage.

**Tool Foot:** The toes of this foot contain (1) screwdriver with changeable heads, (2) adjustable wrench, (3) battery-powered soldiering iron, (4) adjustable socket wrench, (5) wire saw blade.

**Web Foot:** Extends thin webs from either side of foot, as well as webs between toes. Doubles normal swimming speed, plus add +3 to swimming skills.

**Grip Foot:** Toes of this foot can extend and curl around a 2" bar. The soles are covered in a tacky rubberized material for increased traction. Adds +2 to climbing skills.

**Spike Heel:** A 6" spike projects from the heel of this foot, allowing the user to make deadly rear kicks (damage is 2D6AP). Can be used for anchoring or climbing.

### Built Ins

These are options which are constructed within the cyberlimb for specific tasks. Like most cyberweapons, they are designed for maximum concealability, and have a 60% chance of passing a casual inspection if covered with Realskinn™ or a suitably realistic covering.

**Cybermodem:** This option allows the user to carry a small (and very expensive) cybermodem with him at all times. The modem must be jacked into a DataTerm, computer or other

telecommunications line in order to be used. Power (for up to 3 hours) is provided by a rechargeable battery (recharges in 1 hour), or through an external power cord. Program chips are changed through an access port in the limb. The cybermodem is directly jacked into the nervous system through its own internal cables, and does not require external interface plugs.

**Cellular Cybermodem:** This very, very expensive version of a cybermodem allows the Netrunner to interface directly with the Net without a direct telecommunications link. A "CellCyb" can only be used in a major city (population greater than 100,000) where a cell net is present. If used while in a moving vehicle, there is a 25% chance each turn that the connection will be broken and need to be re-established in the next turn.

**Digital Recorder:** This unit can record input from internal microphones, digital recording links, digital cameras, or all three.

**Audio/Video Tape Recorder:** This unit uses microcassettes to store input from its internal microphone, video cam or digital recording link.

**Storage Space:** This is a 2x2x6 inch storage space with a locking cover.

**MiniCam:** This is a small digital camera which pops up from a mount in the upper arm. Internal chip stores 20 images and can be easily changed.

**MiniVid:** A pop up video camera with mini cassettes that can store up to 4 hours of recorded images.

**Hidden Holster:** Leg only. A hidden storage space for holding one autopistol and 1 clip of extra ammo. The size of the leg (based on Body Type) limits the size of weapon which may be stored.

- V.Weak to Weak ..... Light Pistol
- Average to Strong ..... Medium Pistol
- Very Strong ..... Heavy Pistol
- Very Strong ..... Folding Shotgun (2sht.,1/2 range)

**LCD Screen Readout:** This 2"x4" TV screen can display color graphic images. It is normally covered with a transparent screen guard. Images can be taken from digital recorders, minivids and minicams, and cyberoptics. A cable can be extended from an AUX port and plugged into any standard interface plug to transfer images from someone else's cyberoptics or recorders.

**Techscanner:** This device can be hooked up to the diagnostic systems of most vehicles, appliances and personal electronics to determine possible problems and troubleshoot breakdowns.

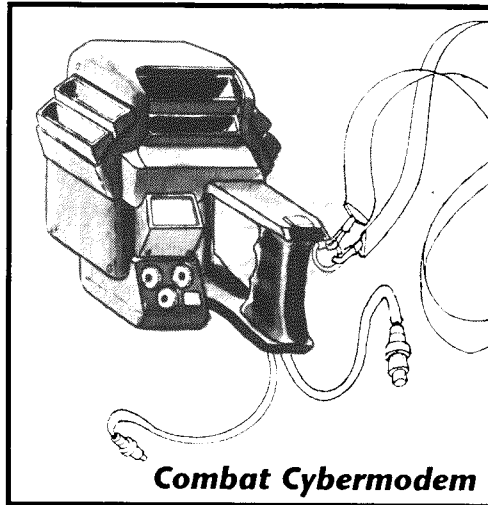

Reliability is 60%. On a successful roll, the difficulty of a repair task is reduced by -3 (you know what's wrong, and you just have to fix it).

## Cyberweapons

One advantage of cyberlimbs is the ability to mount weapons within their framework. Most cyberweapons of this sort are designed for stealth and concealability, rather than raw firepower, and have a 60% chance of escaping detection when hidden under Realskinn™ or other suitable coverings. Weapons include:

**Popup Gun:** This is a standard automatic handgun concealed in a cyberarm. The action is mounted inside a pop-up housing which is covered when not in use. For this reason, you must always remember to uncover your arm when using a popup. Clips are inserted in the side of the action; popup guns are designed to use caseless ammunition only. The size of the cyberarm (based on Body Type) limits the size of weapon which may be mounted (similar to hidden holsters). Note: you may elect to mount any pistol of the correct size listed in the Outfitting section. A light SMG equals a Med. pistol and a medium SMG equals a Hvy. Pistol for this purpose.

**Flamethrower:** This is a small, high-pressure flame jet with a range of 1 meter, and 4 shots. Damage is 2D6 the 1st rnd., 1D6/2 for 2 rnds. afterwards. Soft armor is reduced 2 levels per attack.

**Micromissile Launcher:** This launcher contains four miniature missiles (explosive tipped gyro rounds with heat seeking guidance and steering vents). Like the popup gun, the micromissile

### POPUP GUN SIZES

**V.Weak to Weak:**  
Light Pistol only

**Average to Strong:**  
Medium Pistol or Light SMG

**Very Strong:**  
Heavy to Very Heavy Pistol,  
Med. SMG or built-in  
Shotgun (2sht.,1/2 range)

launcher is stored in the limb and pops out when needed, launching two missiles per turn. The missiles are self-guided (+2WA) and can follow a target through one direction change of 90° or less, giving them the ability to track around a corner (3 in 10 chance of losing target). Reloads cost 50eb each. Damage is 4D6 per missile, range 200m.

**Grenade Launcher:** This launcher is a modified support grenade launcher, stored in a popup mount. One grenade (you may use any standard type) is stored in the launcher; a reload may be dropped in after the first one is used. Note: a standard storage space can hold 2 grenade.

**Weapon Mount and Link:** This is an heavy duty hardpoint mounted either on the underside of a cyberarm, the outside thigh of a cyberlimb, or the top of a shoulder. You may attach externally mounted versions of standard weapons to this mount, jacking their control cables into the side of the hardpoint. You may not wear armor or clothing on the limb while the mount is in use. Available weapons include:

- Grenade Launcher
- Micro Missile Launcher
- Externally Mounted Autopistol (based on body type)

**2 Shot Capacitor Laser:** This micro laser is designed to produce a very powerful pulse of limited duration (3D6 for each one second shot). Range is atrocious (10meters), and recharging requires plugging into a power socket for one hour. However, it can be a particularly effective weapon for assassination or silent attacks. WA=+3

## Linear Frames

Linear frames are the 2020 version of the exoskeleton. An exoskeleton is basically a metal framework with synthetic muscles for movement; you sit in the exoskeleton and steer while it does the work. Early exoskeletons were rarely used for anything important; clumsy and hard to control, hapless operators often tossed half-ton cargo modules through walls and ripped loading doors off hinges. It was not until the advanced bio-feedback systems of the 2000's that the more practical linear frame could be developed.

A linear frame resembles a suit of contoured metal body armor. The frame is

grafted onto your body, while its systems are directly neurolinked to your muscles and bones. Linear frames are designed to take over a *percentage* of the load, while leaving you enough "work" to allow you to gauge how much you're lifting and maintain control of the weight.

For example, if you exert enough force to lift ten pounds, the linear frame provides no more power than would be required to move its own bulk. If you lift a hundred pounds, the linear frame splits the difference, lifting 20% of this mass so that you lift 80 lbs. If you lift 500 pounds, the linear frame takes 80% (400 lbs), leaving you to lift 100lbs. At the top end of the scale (almost 1800 lbs for Linear Ω), the frame lifts 90% of the weight, while you only lift about 180lbs.

But hey, you didn't come here for a physics lesson, right? You wanna know how much you can pick up and throw around.

Linear frames come in three **strengths**. When using the linear frame, you will use its strength value instead of your normal Body Type value for any lifting, bending, carrying or breaking task. Remember; for all their advanced construction, implanted linear frames are still quite heavy (50-100 kg) and bulky. You can't swim in them, and they have a -1 penalty to your REF. But if you want to toss a car out of the way, they're just the ticket. All linear frames lift 50x their Strength value. (Example: Σ can dead lift 600 kg.)

Frame	Strength	Damage Modifiers
Linear Σ	12	+4
Linear β	14	+6
Linear Ω	16	+8

Ω=Omega β=Beta Σ=Sigma

## Body Plating

Body plating covers any situation where armored plastics and metals are layered over and directly anchored to the skin. The armor is microscopically porous, allowing the skin underneath to breathe, and made by sandwiching an ablative plastic shell with energy absorbing microcellular honeycomb.

Body plating doesn't make you any stronger or faster, but it's perfect for the cyborg who wants all over protection all the time—and doesn't care who knows it. It is the ultimate expression of the "metal is better than meat" philosophy; the body-plated look more like robots than they do humans, and are impervious to most of the physical damage that besets us mere mortals. Body plating also includes specialized mounts for sensors as well as body armor.

Body plating is sold in parts, each covering a specific area. It may be placed directly on the skin, or layered over a linear frame exoskeleton for the ultimate in cyborg chic.

**Cowl:** This is a body plate that covers the skull. It is anchored by minibolts to the scalp, and resembles the old skullcaps from bad science fiction or fantasy epics. SP=25.

**Faceplate:** The standard faceplate covers the entire face, with ports for breathing, eating and seeing. The armored plastic material is woven with fine myomar muscle fibers and is relatively flexible. Facial nervelinks allow limited (and somewhat stiff) changes of expression. This modification doesn't *have* to be ugly; many people find the silvery contours and smooth features quite attractive; somewhat like the "sexy robot" airbrushings of the late 20th century. However, many cyborgs like to have their faceplates sculpted into bizarre and often frightening images; monsters out of mythology, or terrifying robotic shapes. It's up to you. SP=25

**Torso Plate:** This section covers the entire upper and lower torso, back and front, with expansion joints at the sides, groin and waist to allow free movement. (SP=25) Reduce your REF by -3.

**Front Optic Mount:** This mount allows up to five cyberoptics to be installed in a shielded cluster in the upper face. The eyes are removed and the orbital sockets used to mount the receiver hardware for the optic mount. Optic mounts come in several styles: there are thin visor slits (ala Robocop), rotating camera clusters (like an old fashioned movie camera), or one main optic with smaller ones arranged in a circle around it. Needless to say, this really screws up your attractiveness stat, automatically reducing it to -1.

**Sensory Extensions:** These are flattened antennae and optic mounts, about a foot to two

feet long. A single cyberoptic and a microphone are mounted in the tip, allowing you to observe things around corners without sticking your whole body into the line of fire. Sensory "booms" are usually mounted on the head or on the upper spine.

## Running Out of Cash?

Just about this time, you're starting to look over the list of cyberenhancements, and you're thinking, "I don't have the kind of Eurobucks I need to swing this newtech." At this point, you have to ask yourself "How desperate am I? Am I really hard up enough to risk death and dismemberment just to get a lousy cyberarm?"

Sure you are.

The truly desperate turn to desperate measures. In this case, you can hire yourself out to someone who can afford to buy your cybernetics for you. **Selecting any one of the following employers is worth 10,000 Eurodollars in cybernetics, free of charge:**

### Join the (Covert) Military

Become a fighter in the Cyberwars, serving your country's armed forces with distinction and honor as part of its secret Elite Mechanized Combat Forces (Cybergrunts, to you). See pain, torture and death close up, as you participate in any one of a hundred covert "police actions" worldwide, protecting "national interests". Of course the Cybergrunts don't exist. Of course your country doesn't send teams of heavily armed covert agents into other countries to kill and foment revolt. Of course they're not going to let you quit when you want to.

### Take Up a Life of Organized Crime

The word on the Street is that the Mob is alive and hiring. Swear allegiance to one of the big time organized crime Families and you'll never lack for cybertech. The only catch is, you have to do "work" for them. Bill collecting. Assassinations. Murders. Mob wars. The Families of 2020 have a long and honorable tradition that goes back into the early twentieth century: nobody ever quits the Mob. Ever.

*"By the second tour, I didn't mind too much. We were makin' good time against the Sandies, and the new cyberarm paid it's way in the first two firefights. Then the recon AV went down over some little pesthole in the Nicaraguan jungle, and when I woke up again, I was legless from the hip. They gave me a choice—disability with a wheelchair, or two legs and another tour. You can see how I went..."*

—Ripperjack



*"We own you, Banner. Body and soul. We don't care how much metal you have, or how many friends you can call on. When we want you, you better come running, and you'd better pray that we don't have to come looking for you first. Because you're Company property, and we can do anything we want with you..."*

*—Boardroom conversation, 2020 AD*

### Sell Out to a Corporation

Join a Corporation and see the world. While you're at it, they'll bankroll you for ten thousand dollars in newtech. But remember, with all business deals, there's a price. In this case, you have to work for the Corporation. The jobs you get to do are all the fun, suicidal ones on which they don't want to waste their good people: executive kidnappings, black operations and espionage missions. If you're really lucky, you'll even get to be a grunt in a Corporate war—you know, the ones that make Vietnam and Afghanistan look like picnics, where you get to defend the Corporation's interests in some backwater hellhole with a population of natives you're suppressing.

Big business is fun.

### The Catch

Like most "free" offers, these employment opportunities are boobytrapped in creative and dangerous ways. Each requires that you work for an indeterminate amount of time (forever) for people you may not like. You'll have to do what they tell you, no matter how cruddy, dangerous or suicidal. Like most powerful people in the Cyberpunk future, they don't like to be crossed, and have a variety of awful ways to ensure your "cooperation":

**Hostages:** To ensure your good behavior, the controlling agency is holding someone you care about hostage. You mess up, they die—or worse.

**Blackmail:** Somewhere in your past, you did something you can't afford to let out. It could be as small as cheating on your taxes (with a 20-year jail term), or a murder rap. It may even be fictional—created by your new employers to make sure you toe the line. Are you willing to take the chance?

**Sabotage Chipware:** To make sure you stay in line, the controlling agency has buried lethal glitches in your cybernetic software. Things to make your heart stop on command. Programs that give you blinding headaches if you refuse to follow an order.

**Monitored:** Your employers have implanted

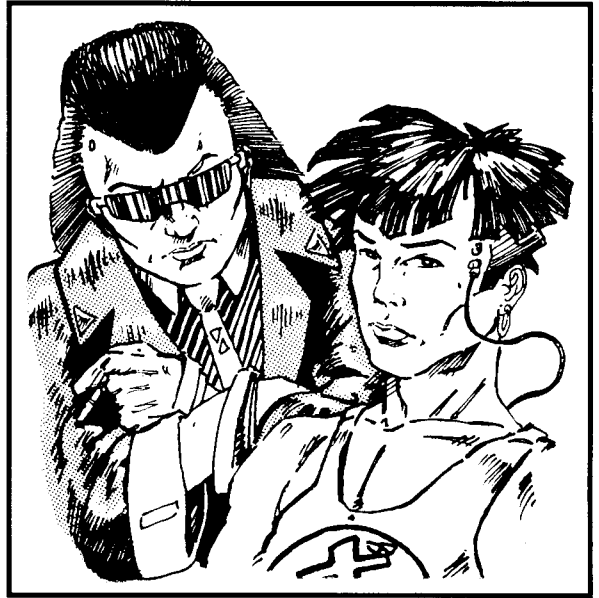

sensors or other monitoring devices on you—just to ensure your loyalty. You can't say or do anything without them knowing. You can't go anywhere without them finding you. The worst part is, you don't know where in your body they've hidden these devices.

**Command Kill:** A really vicious sabotage chip—on the command word, you will kill whomever you are directed to kill—without control, regret or mercy. Your mother. Your lover. Your cat. Anyone.

**Company Safeguard:** Another nasty sabotage chip. You can't willingly harm any member of the controlling agency—to do so will cause you excruciating pain. To continue will cause even more pain, culminating in full heart stoppage and a screaming death.

**Remote Detonator:** One of the favorite corporate tricks, this is a small package of inert explosive buried somewhere in your body, activated by a remote radio signal. You don't know where they put it, the scanners can't find it, and if you did go around looking, you're likely to set it off (60%). Wanna bet your life, cobber?

Sounds fun? Remember, if you join one of these groups, any one (or more) of these little goodies applies directly to making you a puppet of your employers. What you are forced to do, and what they hold over you, is up to the Referee. He doesn't even have to tell you. You don't have a choice. You just sold your soul.

Welcome to 2020, smartboy.



*"It's a clean cold  
feeling,  
just me and the  
chill,  
The victim, the  
heat,  
and the  
Edge-induced  
thrill.  
The afterglow of  
life,  
The prey paying  
the bill.  
Loving the  
Street,  
Making the kill.  
Solo."*

*—Toby the  
Hammer  
"Solo"  
Big Russia Music,  
2019*

*"Frag that.  
These guys kill  
people for a  
living. The only  
place where a  
gunfight is  
romantic is in a  
James Bond  
novel."*

*—Morgan Black-  
hand*

*Savage threw himself against the wall as the first slugs slammed in. Bricks shattered around him like cheap glass as he propped the Scorpion 16 against the wall and cut loose—*

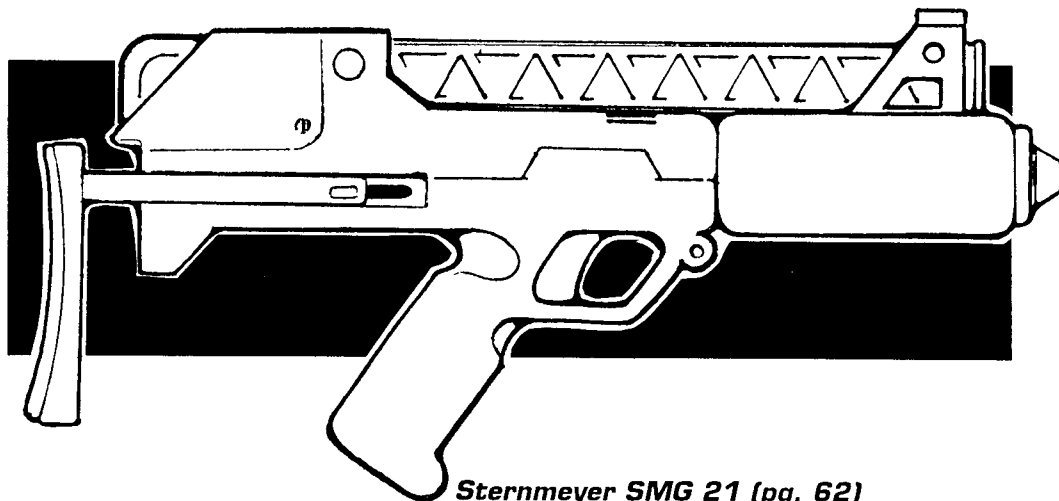

**Sternmeyer SMG 21 (pg. 62)**  
SMG•1•L•E•11mm•30•15•VR•50m

# SECTION 7 FRIDAY NIGHT FIREFIGHT

**Friday Night Firefight (FNFF)** is a weapons combat system for using modern, futuristic and archaic firearms in *Cyberpunk* adventures. It's designed to cover all major elements of weapons combat in an easy to use format, allowing realistic firefight action without resorting to lots of tables and charts. FNFF also covers melee weapons, hand to hand combat and martial arts as well, all in a simple system that allows you to use strategy over firepower.

There's a lot of vague ideas and theories about modern weapons encounters—most of them from the Hollywood Never-Empty-Six-Gun-School of Armed Combat. These misconceptions have

crept on little flat feet into the design of many roleplaying games, leading to characters who can be repeatedly shot with large caliber handguns until they run out of "hit points" and who can fire Ingram MAC-10's one-handed and hit with every bullet.

In otherwords, good, clean fun.

FNFF is not good, clean fun. Most of the data herein has been compiled from ballistics reports, police data, FBI statistics and other not-clean fun sources. These sources tend to point to a couple of basic truths about firefight combat.

80% of most gunfights occur between

untrained amateurs at a range of 21 feet. 40% of these raging gun battles happen within 8 feet or less! Most (60%) occur in dimly lit and difficult conditions— dark, rainy alleys, with both participants panting and out of breath, pausing momentarily to snap off a badly aimed shot at a fleeing shadow, then ducking back for cover. Hits are surprisingly rare. When they do occur (assuming a large caliber weapon's involved), the victim is usually hors de combat on the first shot from a combination of wound- shock and terror. A solid hit with a .44 magnum will usually splatter a real person all over New Jersey.

On the other hand, this is *Cyberpunk*, right? So why are we telling you all this if we don't intend for you to go in there with guns blazing? If a large caliber handgun is truly something to be respected, who wants to lose character after character until they get the point?

Here's where we get interfaced, gangboys. We've made this edition of FNFF simpler, faster and more direct, so you can concentrate on how to fight; how to win every encounter (you'll only get to lose once). We're going to give you all the tips we've learned over hundreds of our own encounters, plus hot tips from cops, combat grunts, SWATmasters and other veterans who've put it on the line for real.

It's true— a firefight is dangerous. But you can handle it. That's why you're *Cyberpunk*.

## THE BASICS

### Rounds & Turn Order

Combat in FNFF is divided up into **rounds**, each representing @3 seconds. Every round, each player gets to do something. The order of the round is based on an initiative roll of 1D10 plus the players REF stat, with highest rolls moving first to lowest rolls

moving last. Reflex boosts are added to this roll where applicable.

**INITIATIVE= ROLL 1D10+REF.  
HIGH ROLL FIRST.**

*Example: Players A, B and C all have REF stats of 10. A rolls a 5, B rolls an 8, and C rolls a 2. Turn order will be B, then A, then C.*

### Wait For Your Turn

You can elect to act later in the round, stepping in at any point to act. If you have elected to wait until another player's turn has come up, you will be able to act after they have taken their turn in the round.

*Example: Turn order is player A, then B, then C. Player A decides to wait until player C has moved from cover, then take his shot. By waiting, the new turn order will be B, C then A.*

### Party Initiative

You may want to speed up your play by designating one member of the group as the party leader and have him roll initiative for the whole group. His roll is added to REF scores of everyone in the group to determine when each member of the group will act.

### The Fast Draw or Snapshot

By declaring a **fast draw** (aka *snapshot*) at the start of the round, you automatically add +3 to your initiative roll, taking a -3 penalty to hit (you're rushing into combat instead of preparing carefully). You also may not take advantage of scope, sights or other aiming advantages. The martial arts or melee version of this technique is called the *iai-jutsu* or lightning strike.

**FAST DRAW= +3 TO  
INITIATIVE, -3 TO HIT**

### SO WHAT GOOD IS REFLEX BOOST?

Plenty. Them what goes first, kills first (or at least have the option of acting first). Most firefights start and end in only a couple moments. Which is one reason why you may want to think twice before you just haul out a gun.

The other reason boosts are worthwhile is that they make you harder to hit— you're moving so fast, it's hard to draw a bead on you.

### WHY SOLOS ARE PARTICULARLY BAD NEWS

The advantage of the Solo is *Combat Sense*. For each level of *Combat Sense*, you'll add +1 to your Initiative rolls. Between Solos, this advantage is going to even out, but when Solos meet other types of characters, look out.

Remember: Solos are the equivalent of hired killers, and killing is what they do best.

### AWARENESS OPTIONS

One way to make Awareness rolls a real surprise is to have your players make ten Awareness rolls before the game commences. Write them down in order for each player. When an Awareness roll is required, go down the list in order, checking to see if the rolls are high enough to succeed. The same table can be used over and over again by rolling 1D10 at the beginning of a new combat, then reading the list starting at the rolled number (ie: you roll a 5. You will start your new Awareness rolls at the 5th check, going through the rest of the list in order of 6,7,8,9,10,1,2,3,4,5.

	A	B	C	D	E	F
1						
2						
3						
4						
5						
6						
7						
8						
9						
10						

*Example: Ripperjack is faced with his long time enemy, Hargan. He knows Hargan has a higher REF than he does, so he elects to make an all out, blazing attack before the giant can get in a move. The snapshooting bonus will give him the +3 advantage he needs. Ripperjack's mono-katana arcs out in a searing iai-jutsu before Hargan can raise his own sword. Unfortunately, the -3 point penalty for snapshots works against Ripperjack, and his attack misses his opponent by a mile.*

### Actions

During your part of the round, you may perform one **action** without penalty. This includes:

#### ACTIONS

- **Move up to your full Movement (3x your Movement Allowance in meters) per round.**
- **Attack up to your weapon's maximum Rate of Fire (ROF), or make a Melee attack.**
- **Dodge (making yourself harder to hit. Melee attacks only.)**
- **Parry (deflecting damage onto something else.)**
- **Escape a hold or trap.**
- **Aim (gaining +1 to hit for every consecutive turn of aiming up to 3 rounds)**
- **Reload or change weapons.**
- **Mount or dismount from a vehicle.**
- **Repair or give Medical Aid.**
- **Perform a non-combat task.**

### More Than One Action

You may perform more than one action at a -3 penalty to each successive action.

### Two Weapon Attacks

Two weapon attacks can be made at a -3 to hit penalty on both weapons used.

### Ambushes & Backstabs

Sometimes, the best way to deal with a very powerful opponent is to get the drop on him from behind; in short, setting an

ambush. Ambushes gain a +5 to hit advantage. You may ambush or backstab by announcing your intent to hide or lie in ambush for a target. You can elect to set up an ambush any time:

a) The opponent is unaware of your location and your intention to attack. This can be accomplished by setting up a hiding place ahead of time or taking advantage of a melee to get under cover and waiting for a shot. A victim of an ambush must make an Awareness roll greater than your *Stealth Skill*+*INT*+1D10, or you have automatically succeeded.

b) The opponent's attention is on another situation, such as another attack or a task requiring great concentration. This can be accomplished by creating a distraction for your opponent, or by sneaking up on him while he is in combat with another combatant.

**AMBUSH=+5 TO ATTACK FOR 1 ROUND**

An ambush doesn't mean you act first—it just means you have an attack advantage. Initiative for the round is made as usual, and the ambushing character can spring the trap on his part of the round or can wait to see what develops before making his attack. Until the attack is made, his opponent may not attack him, because he doesn't know he's in danger. An ambush may only be used for one attack; another ambush must be set up before the bonus can be employed again.

*Example: Ripperjack decides to set up an ambush in a dark alley of the City. He rolls his Stealth Skill+Int+1D10 for a total of 18. Along come Scarr and Hargan, his mortal enemies.*

*At the start of the combat turn, initiative is Scarr, Ripperjack and Hargan. As they enter the trap, both Scarr and Hargan make Awareness Rolls. Scarr's roll is 12; Hargan's is 20. "It's a trap!" yells Hargan, but too late; Scarr didn't know what was coming and couldn't declare an attack or defense. Ripperjack pegs him with a shot from his H&K Hellfire, using the +5 Ambush bonus. He won't get the bonus on Hargan, because the blond giant*



## ATTACK MODIFIERS

### WEAPON RANGES

Handguns	50m
Submachineguns	150m
Shotguns	50m
Rifles	400m
Throwing	10m x BOD (-10m/kg. > 1)

### TO HIT NUMBERS

Point Blank (Touching to 1m)	10
Close (1/4 Long range)	15
Medium(1/2 Long range)	20
Long (Full range)	25
Extreme (2x Long range)	30

### MODIFIERS (ADD TO ATTACKER'S ROLL)

Target immobile	+4
Target dodging (melee only)	-2
Moving Target REF >10	-3
Moving Target REF >12	-4
Moving Target REF >14	-5
Fast draw/Snapshot	-3
Ambush	+5
Aimed shot at body location	-4
Ricochet or indirect fire	-5
Blinded by light or dust	-3
Target silhouetted	+2
Turning to face target	-2
Using two weapons	-3 on both
Firing while running	-3
Firing shoulder arm from hip	-2
Turret mounted weapon	+2
Vehicle mounted, no turret	-4
Large target	+4
Small target	-4
Tiny target	-6
Aiming	(+1 each round, up to 3 rounds)
Laser Sight	+1
Telescopic Sight	+2 Ext, +1 Med
Targeting scope	+1
Smartgun	+2
Smartgoggles	+2
Three Round Burst (Close/Medium only)	+3
Full Auto, Close	+1 for every 10 rnds
Full Auto, all other	-1 for every 10 rnds

## AREA EFFECT TABLE

Type	Area
Grenades	5m
Molotovs	2m /liter
Flamethrower	2m
Cyberlimb flamethrower	1m
Mine	2m
Claymore	6m line from center of explosion
C-6	5m /kg
RPG	4m
Missile	6m
Shotgun (Close)	1m
Shotgun (Med)	2m
Shotgun (Lng/Ext)	3m
Micromissile	2m each

## GRENADE TABLE

	10	
7	8	9
5	TARGET	6
2	3	4
	1	

ROLL 1D10 IF GRENADE THROW MISSES; ROLL SECOND D10 FOR METERS FROM TARGET SPACE

## DRUGS & POISON

Type	Effect	Damage
Hallucinogen	Confusion	-4 INT
Nausea	Illness	-4 REF
Teargas	Tearing	-2 REF
Sleep Drugs	Sleep†	None
Biotoxin I	Death	4D6
Biotoxin II	Death	8D6
Nerve Gas	Death	8D10

†Half effect is drowsiness, -2 to all stats.

## MICROWAVE EFFECTS

### MICROWAVER SIDE EFFECTS

- Cyberoptics short for 1D6 turns
- Neural pulse! If character has interface plugs, reflex boosts or other hardwiring, REF stat reduced by 1D6/2 until repaired.
- Cyberaudio shorts for 1D6 turns.
- Cyberlimb malfunction: Lose all use of cyberlimb for 1D10 turns. Roll 1D6 for limb, rerolling if no limb present
  - 1-2 .. Right Arm
  - 3 .. Left Leg
  - 4 .. Right Leg
  - 5-6 .. Left Arm
- Total Neural breakdown! Character reduced to twitching, epileptic fit for 1D6/3 turns.
- No Effect.

## ADD TO DAMAGE

Strength	Add to Damage
Very Weak	-2
Weak	-1
Average	+0
Strong	+1
Very Strong	+2
Body Type 11-12	+4
Body Type 13-14	+6
Body Type 15+	+8

## COMMON COVER SPS

Sheetrock Wall	5
Stone Wall	30
Tree, Phone Pole	30
Brick Wall	25
Concrete Block Wall	10
Wood Door	5
Heavy Wood Door	15
Steel Door	20
Concrete Utility Pole	35
Data Term™	25
Car Body, Door	10
Armored Car Body	40
AV-4 Body	40
Engine Block	35
Mailbox	25
Hydrant	35
Curb	25

## ARMOR SPS

Type of Armor	SP*	EV†
Cloth, leather√	0	+0
Heavy Leather	4	+0
Kevlar T-Shirt, Vest√	10	+0
Steel helmet	14	+0
Light Armor Jacket√	14	+0
Med Armor Jacket	18	+1
Flack vest√	20	+1
Flack Pants√	20	+1
Nylon Helmet	20	+0
Heavy Armor Jacket	20	+2
Doors Gunner's Vest	25	+3
MetalGear™	25	+2

\*AP rounds: treat Armor as if half SP  
√=Edged weapons treat SP as half

† (EV) Encumbrance Values should be added together and subtracted from character's total REF Stat.

## CYBERWEAPON DAMAGE

Weapon	Damage
Scratchers	1D6/2
Fangs	1D6/3
Rippers	1D6+3 (AP^)
Wolvers	3D6 (AP^)
Big Knucks	1D6+2
Slice n' Dice	2D6 (mono)
Cybersnake	1D6
Hammerhand	1D10
Buzzhand	2D6+2
Spikehand	1D6+3AP
Talon Foot	1D6
Spike Heel	2D6AP
Flamethrower	2D6 (1D6/2†)
Micro Missile	4D6ea
Capacitor Laser	3D6
Cyber Strike	1, 2* or 3D6**
Cyber Kick, Crush	2, 4* or 6D6**

\*\*with hydraulic rams    \*thickened myomar  
† secondary damage 3 rounds.    ^ knife AP

### MARTIAL ARTS FORMS & SPECIALIZATION BONUSES

Style and Difficulty Lvl.	Strike	Kick	Block	Dodge	Throw	Hold	Escape	Choke	Sweep	Grapple
Karate (2)	+2	+2	+2	—	—	—	—	—	—	—
Judo (1)	—	—	—	+1	+3	+2	+2	—	+2	+2
Boxing (1)	+3	—	+3	+1	—	—	—	—	—	—
Thal Boxing (4)	+3	+3	+2	—	—	—	—	—	—	+1
Choi Li Fut (3)	+2	+2	+2	+1	+1	—	—	—	+2	—
Alkido (3)	—	—	+4	+3	+3	+3	+3	+1	+3	+2
Animal Kung Fu (3)	+2	+2	+2	—	—	—	—	—	+1	—
Tae Kwon Do (4)	+3	+3	+2	+1	—	—	—	—	+2	—
Savate (2)	—	+4	+1	+1	—	—	—	—	—	—
Wrestling (1)	—	—	—	—	+3	+4	+4	+2	+2	+4
Capeoira (3)	+1	+2	+2	+2	—	—	—	—	+3	—

made his Awareness roll and spotted him. His second shot misses, and Hargan throws himself down behind a wrecked car and opens up with his 20mm autocannon. Savage fades down the alleyway to set up another trap.

#### Line of Sight and Facing

Whenever you are facing your target and have a clear path between you, you can attack. You can clearly see anything forward of your shoulders. Illustrations of clear paths and facings are on pg. 107.

#### Damage

**Damage** in combat is determined by rolling groups of six-sided dice. If a rule says, "roll 2D6", for example, you would roll two six sided dice, total the results, and apply the total to the target you were attacking. If the rule said "roll 2D6+1", you would roll as above, then add 1 to the total.

So much for creating damage. Let's take a step-by-step look at how to *apply* it.

#### Hit Location

The first step in applying damage is to figure out *where* to apply it. Most combat attacks are just barely aimed; you're looking for an opening, your opponent slips up, and you

take it. This means that unless you attempt to aim your shot at a specific location (and take the -4 penalty for this), you will have to determine where you hit on a random basis.

The **Location** section of your Hardcopy Form is designed for this; it lists all body areas with a value from 1 to 10 written underneath. When your character is hit, roll 1D10 and compare the chart number to the roll to determine where he has been hit.

Use some common sense with this rule; for example, if a character is standing behind a low wall, a roll of 7-8 (R.Leg) is pretty silly. Ignore it and re-roll.

#### Armor

Armor is what stops targets from taking the damage you just located. The *Armor SP* section is

directly under the Location section on the Hardcopy. Write the Armor Stopping Power (SP) value for each body area in the space corresponding to that body area.

Stopping power (SP) refers to the ability of armor to stop damage. Each type of armor has it's own Stopping Power. When the armor is struck by a round, the armor's SP is subtracted from the total amount of

**"Rated SP20.  
You can walk  
through fire.  
Just like the  
holos,  
choomba..."**  
—Unidentified Fixer  
2015

damage done by the hit. The remaining damage is then applied to the target area. If the damage done is less than the SP of the armor, no damage is done.

*Example: Ripperjack is wearing a Kevlar jacket with an SP of 18. A 5.56 round strikes him in the chest, causing 14 points of damage. The armor's higher SP thwarts the attack. The next shot does 22 points of damage. The armor reduces this by 18 points. Only 4 points get through to cause Ripperjack harm.*

### Hard and Soft Armors

Body armors are divided up by whether or not the majority of their protection is based on rigid metals/ceramics/composites, or on softer, more flexible ballistic fabrics. This is done for layering purposes and for some weapon damage effects. The table below is arranged with heaviest protection at the top, lightest at bottom.

### HARD/SOFT ARMOR TABLE

HARD ARMORS	SOFT ARMORS
Metal Gear	Heavy Armor jacket
Police riot armor	Med. Armor jacket
Door Gunner's vest	Police patrol armor
Steel helmet	M-78 RPA jacket
Flak vest/pants	Light Armor jacket
Ballistic Nylon helmet	Kevlar T-shirt/vest
M-78 RPA heavy vest	M-78 RPA T-shirt
Corp Mil body armor	Heavy Leather
C-Ballistic Light Mesh™	SkinTight™ armor padding

RPA=Militech Revised Personal Armor, AP-defeating, CorpBook 2 C-Ballistic Mesh, SkinTight Padding=Interface vol1, #1-2

**Layering Armor:** "What a concept", you think, shrugging into a bulletproof T-shirt, bulletproof vest and a Kevlar armor jacket. Theoretically, one should be able to layer protection upon itself until he becomes invulnerable.

Wrongo. First of all, let's look at reality. If the average cop could stack layers of armor on himself before tackling a domestic disturbance call, you can bet he'd do it. But he doesn't, because it just isn't practical. Here's why.

When you layer flack jackets, you aren't invulnerable; you're just immobile. While modern armor isn't as heavy as old fash-

ioned armor plate, it's very encumbering from the movement angle. Straps, buckles, padding and stiff plastic add up to restrict arm movement, chafe the torso, and weigh down the legs. Pillsbury-doughboy padded arms don't lift guns very well, and well-stuffed legs aren't much for bending, climbing and running.

For this reason, every armor type in FNFF has an *encumbrance value* (EV). When wearing body armor, add up the total of EV's (listed in the *Armor Table*), and subtract this from your character's REFLEX stat. Even if you're cybered up, a lot of armor is gonna cost you.

### New Armor Rules:

These new rules (previously published in CP 2020 erratta sheets) have been added to clarify the armor question and deal with a reoccurring problem.

#### New Rule 1: Maximum Armor

Now, in addition to Encumbrance Values, only a maximum of **3 layers** of Armor can be worn at any one time; no more than **one** of these layers can be Hard Armor (see Hard/Soft Armors Table). The 2nd layer has an *extra* EV penalty of **-1**; the 3rd layer, an *additional* penalty of **-2**. *Subdermal Armor* and *Bodyplating* cyberware options are considered to be armor layers; *Skinweave* is considered a layer, but receives no penalty.

#### New Rule 2: Proportional Armor

When layering armor, or wearing armor behind an obstacle or cover, subtract the smaller SP from the larger one. Find the difference on the table below and read across to the other column. This is the bonus number you add to the **larger** SP to determine **overall** protection from the armor/armor, or armor/cover combination. If you have three or more layers of protection, calculate in pairs from the inside out. (example: For armors A, B, C, you compare A and B; determine the bonus number, and then compare the new strength of the larger of the pair to armor C.)

### ARMOR

Let's clear up a couple things about ARMOR right now. When we talk about Armor Stopping power, we're not talking about whether the bullet (knife, club, sword, etc.) has actually gone *through* the armor. What we're really measuring is the abstract idea of whether any *damage* got through. This might not be an actual bullet or blade, but rather a bruised rib from a big slug or even minor concussive damage from a baseball bat.

In short, if the armor stopped the attack, this means that no harm actually goes through to the character, regardless of the fact of where the bullet ended up. Sure, even if a vest physically stops a .357 Magnum round, at pointblank range, you'll get some big bruises.

The idea of armor piercing also works into this; the chances that a knife will slice through the layers of kevlar are higher than for a blunt bullet, and this means that more of the knife will actually get through to your ribs. Armor piercing attacks are deadly because they can ignore modern armor's biggest advantage: the ability to spread kinetic impact over a wide area, slowing the bullet down and stopping it from actually entering the body.

Even blows and energy beams can be stopped by modern armor; made of composite fabrics and ceramic inserts, armor will tend to ablate under energy attacks, and absorb kinetic energy.

Write the SP (described in the ARMOR SECTION, pg.91), for the armor you're wearing over each body area. For example, an Armor Jacket covers your Torso and both arms in an SP of 16. So you would write 16 in the boxes for Torso, R. Arm and L. Arm.

When you take damage, subtract the SP of the armor from the amount of damage taken. The remainder, if any, is what gets through to YOU.

When taking damage, roll 1D10 to determine where you have been hit, comparing the roll with the numbers below.

**Death Saves:** When making a Death Save (anytime your wound state is at Mortal), you must roll your Save number minus the mortality level of the wound. For example, Mortal 5 means I would roll my Save number -5.

Location	Head 1	Torso 2-4	R.Arm 5	L.Arm 6	R.Leg 7-8	L.Leg 9-0
Armor SP						

SAVE	BTM	LIGHT	SERIOUS	CRITICAL	MORTAL 0	MORTAL 1
		<input type="checkbox"/>	<input type="checkbox"/>	<input type="checkbox"/>	<input type="checkbox"/>	<input type="checkbox"/>
		Stun=0	Stun=-1	Stun=-2	Stun=-3	Stun=-4
		MORTAL 2	MORTAL 3	MORTAL 4	MORTAL 5	MORTAL 6
		<input type="checkbox"/>	<input type="checkbox"/>	<input type="checkbox"/>	<input type="checkbox"/>	<input type="checkbox"/>
		Stun=-5	Stun=-6	Stun=-7	Stun=-8	Stun=-9

This is where you would write your Save Values. Both are equal to the number of points you have placed in your Body Type (for example, a Very Strong Body Type would be a 10, and have a 10 Save as well).

Your BTM stands for Body Type Modifier (see Page 93). Not all body types take damage the same. You will subtract this number from any damage you actually take.

This is your Wound section. For every point of damage taken, mark off one box, moving from left to right, top to bottom. The top row (Light, Serious, etc.), describes the current condition of the character; the bottom (Stun=0, etc.) tells what you must subtract from your Stun Save each time you take a wound. For example, Stun 5 would mean subtract 5 from your regular Stun Save value.

### PROPORTIONAL ARMOR TABLE

Difference in SPs	Bonus Number
0-4	+5
5-8	+4
9-14	+3
15-20	+2
21-26	+1
27+	+0

### Armor Piercing Rounds

There's another reason why armor isn't the universal cure for flying lead, and it's called *Armor Piercing* (AP) rounds. These are bullets designed to deliver their full impact to a single point, instead of mushrooming out like a normal bullet. They don't cause as much damage as a standard lead or hollow point round (1/2 normal damage), but they cut through armor like a hot knife through cheese. As a result, whenever AP rounds are encountered, armor will have one half it's total SP value.

For example, say a 5.56 AP round causes 30

points of damage. It hits SP 10 armor, which reduces it by 5 ( $10/2=5$ ). The remaining 25 points are further reduced to 12 ( $25/2=12.5$ , rounded down to 12), based on an AP round's lower damage capacity.

The same is true of knives, swords and other *edged weapons*. Note that armors marked with a check (✓) on the Armor Table are at half SP effectiveness against edged weapons.

The smart solution in a combat situation is to rely on the lightest armor you think you can get away with unless you're planning to take on a stationary position or go up against very heavy firepower.

**Staged Penetration:** Armor doesn't just keep absorbing damage indefinitely. One option is to use the concept of *Staged Penetration*. Each time the armor is struck by a penetrating attack (i.e., an attack that actually exceeds the armor's SP), it's SP is reduced by 1 point. When the SP reaches 0, the armor will no longer stop damage.

## Use Cover

You don't have to lug around an armor jacket with you—often the best armor is what you can find around you. Cover allows you to move from place to place, letting something else soak up the gunfire.

### COMMON COVER SPS

Sheetrock Wall	5
Stone Wall	30
Large Tree, Phone pole	30
Brick wall	25
Concrete Block Wall	10
Wood door	5
Heavy Wood Door	15
Steel Door	20
Concrete Utility Pole	35
Data Term™	25
Car body, door	10
Armored Car body	40
AV-4 Body	40
Engine block	35
Mailbox	25
Hydrant	35
Curb	25

## The Body Type Modifier

The next step after Armor is to apply your character's **Body Type Modifier** to the damage. This is a special bonus which reduces the effects of damage, reflecting the stamina and general toughness of the character. Each time your character takes damage, **subtract** your Body Type Modifier from the total amount of damage before applying it to your character.

### BODY TYPE MODIFIER TABLE

Very Weak .....	-0
Weak .....	-1
Average .....	-2
Strong .....	-3
Very Strong .....	-4
Superhuman* .....	-5

\*Possible only with cybernetics

For example, say you took ten points of damage. If you were a Very Weak Body Type, you would take the full ten. But with a Very Strong Body Type, you'd only take (10-4=6) six points of damage.

The A. Swenson Memorial *He Shrugs Off Damage Like An Old Overcoat Rule*: Occa-

sionally, you'll encounter a situation where the combination of armor and Body Type Modifier will seem to reduce the damage done to zero or less. A **Body Type Modifier may never reduce damage to less than one**—in these cases, the character will automatically take 1 point of damage.

## Wounds

Okay, so the Armor didn't stop all of the damage, and your *Body Type Modifier* wasn't enough to shrug off the rest. It's time to take a *Wound*.

The *Wound* section of the Hardcopy Form is used to record damage. For each point of damage taken, check off one box, moving from left to right, top to bottom. The top line of this section (marked LIGHT, SERIOUS, CRITICAL, MORTAL, etc.) tells the overall state of the character's health.

### WOUND EFFECTS

- At a LIGHT wound level, a character suffers no penalties to his activities. He just hurts a lot ("It's only a flesh wound...").
- At a SERIOUS wound level, the character will be at -2 to his REF stat for all actions. He's hurting, bleeding, and definitely hampered.
- At a CRITICAL wound level, the character's REF, INT and CL stats are automatically reduced by half (round up). The character is holding his guts in with one hand and doing his damndest to stay in the battle.
- If MORTALLY wounded, the character's REF, INT and CL stats are reduced to 1/3rd normal (divide by 3, rounding up). Most characters are already out of the action by now, and are quietly going about the business of expiring. Messily.

## Special Wound Cases

**Limb Loss:** If a character takes more than eight points of damage to a limb area in any one attack, the area is severed or crushed beyond recognition. The character must make an immediate *Death Save* at Mortal 0. A head wound of this type will kill automatically.

**Head Hits:** A head hit always doubles damage.

## DO UNTO OTHERS, BUT COVER YOUR BUTT

Remember that cover doesn't always mean automatic safety. If your target is hiding behind a wood door and you have a rifle, go ahead and shoot through the door; the penalties for blind firing won't stop you if you're at point blank range.

If he's behind a car door, so much the better; it takes an engine block to stop a serious bullet. If you think he's hiding behind the door of the apartment you're about to enter, make an *Awareness* check to see what side he's on, then shoot through that sheetrock wall.

When you're on the Street, make sure you not only know where cover is, but its general SP value. If the hit team comes down on you, make sure you have a Data Term to dodge behind—they make those things tough enough to stand an automobile crash. If there's no cover available, try lying in the gutter; curbs work great if they're high enough.

Also, check your lines of sight. Remember, cover doesn't count jack if the guy shooting at you is higher than you are. And don't neglect the power of suppressive fire as cover; sure, you probably won't hit at a long range, but the chance that you might will make him keep his head down.

Pay attention to this, punkers. The graveyards are full of real people who didn't.



### KNOCKBACK

Okay, let's talk about *knockback*. You know, where you shoot the guy and he hurtles back ten feet, arms windmilling, to crash through a convenient plate glass window?

Unfortunately, this is another Hollywoodism. Why don't we have knockback? Blame Issac Newton's Third Law (of Equal and Opposite Reactions). The fact is, if you can deliver enough energy to knock a man off his feet, Physics says that the guy firing the gun will also fly back ten feet as well. And that just doesn't happen.

A real gun can't deliver that much energy anyway; a bullet hasn't got the *mass*. For example, a Winchester 458 Magnum Super X only delivers 4712 foot-pounds of energy direct from the muzzle (that drops off to 1200 ft-lbs past the first 500 yards). You can deliver more energy by hitting your target with a pair of nunchucks.

Okay, so what do gun experts mean when they talk about "stopping power"? What they really mean is the amount of tissue damage the weapon can cause on impact. The bigger and heavier the bullet, the more ripping and tearing damage it'll do, and the faster the target will drop from shock and tissue damage.

Which is what a Stun/Shock Save is all about.

### Stun/Shock Saves

Every time a character takes damage, he must make a *save* against the effects of pain, shock, fear and blood loss. This is what you see in most Hollywood gunfights when the bad guy gets hit—staggering, falling back and so on, all caused by pain and shock (see the sidebar for a general tirade about the fiction of *knockback*).

The *Stun Shock Save* is a serious thing, because it can put an opponent out of the picture faster than the actual damage from the wound. Police officers have actually died from the shock of a minor bullet wound in the foot (but we won't do that to your character). Other people have taken as many as thirty or forty gunshots and managed to keep moving for up to *ten minutes* before their minds got the message their bodies were telling them ("Hey Bob, you're *dead!*").

The *Stun Save* is equal to your character's *Body Type* value, *minus* a penalty based on his current *Wound State*.

### STUN/SHOCK SAVE MODIFIERS

Wound State	Penalty
Light .....	0
Serious .....	-1
Critical .....	-2
Mortal .....	-3
Mortal 1 .....	-4
Mortal 2 .....	-5
Mortal 3 .....	-6
Mortal 4 .....	-7
Mortal 5 .....	-8
Mortal 6 .....	-9

A failed roll means the character is out of combat. You can add the special effects yourself:

### HOLLYWOOD OVERACTING EFFECTS TABLE

Roll	Effect
1 .....	Screams, windmills arms, falls.
2 .....	Crumples like a rag doll.
3 .....	Spins around in place, falls.
4 .....	Clutches wound, staggers and falls.
5 .....	Stares stupidly at wound, then falls.
6 .....	Slumps to ground, moaning.

A Stun/Shock roll can be recovered from by rolling a successful check in a subsequent turn.

### Very Important: Death Saves

Unless you have taken a *Mortal Wound*, your character is in no danger of dying; he only needs to make his initial *Stun* save to remain conscious. But if the wound is a MORTAL one, he has a chance of dying.

**Most characters are already out of action, and are quietly going about the business of expiring. Messily.**

Determining whether he survives requires that a *Death Save* be made, with a new save required every turn that the character remains untreated.

Like a Stun Save, a Death

Save requires that you roll a value on 1D10 equal to or lower than your character's *Body Type* score, subtracting the level of severity for the wound from your base chance to save. *Mortal Wounds* are rated from 0 to 8.

*Example: Hargan is Very Strong and takes a Mortal 4 wound. He must roll lower than (10-4)=6 to stay alive.*

Each turn, you must make another Death Save to see if you survive to the next turn. On a successful roll, you make it; on a failed roll, you will die at the *end* of the turn in which the roll was made.

Sooner or later, you'll fail a roll and die. The only way out is **stabilization**.

Stabilization means the patient is no longer losing blood and that his major damage has been contained through use of drugs, battlefield surgery and/or wound dressing. A stabilized character will no longer be required to make Death Saves each turn. Anyone (except the patient himself) can attempt to stabilize a mortally wounded character; it just works better if the physician has had some medical training. A lot better.

A successful stabilization is made by adding your TECH stat, any Medical Skill and one D10 for a result equal to or higher than the total number of damage points the patient has taken. For example, Ripperjack has taken 20 points of damage, placing him in a Mortal 1 Wound State. To stabilize him will require a roll of 20 or greater. Once stabilized, the character is no longer in danger of dying unless another wound is taken. At this point, the whole messy business begins again...

The chances of a successful stabilization roll can be increased by the following modifiers, added to your die roll.

Advantage	Add to die roll
Full Hospital & Surgery .....	+5
Trauma Team Ambulance .....	+3
Life Suspension Tank .....	+3

Assuming you make your stabilization rolls, you're going to survive to fight again. If you fail, no problem, that's why we have Body banks. Either way, to learn more about **healing** or **spare parts brokering**, check out the *Trauma Team* section, pages 114 to 125.

## Making Attacks

**This section covers the basics of how to make attacks. There are two parts to this section: RANGED WEAPON COMBAT and MELEE COMBAT.**

### Ranged Weapons

Ranged weapons are anything that is shot or thrown over a distance at the target. To **make a ranged weapon attack** (guns, bows, thrown objects, etc.) you must roll a combination of your:

**REF STAT+WEAPON  
SKILL+1D10**

equal to or greater than a specific hit number. The hit number is determined by the range between you and your target.

### HIT NUMBERS

Point Blank .....	10
Close .....	15
Medium .....	20
Long .....	25
Extreme .....	30

### Range Definitions

- **Point Blank:** The weapon is very close to or in actual physical contact with the target. It will almost always hit, doing maximum damage.
- **Close:** The weapon is attacking at one quarter of the listed range.
- **Medium:** The weapon is attacking at one half of the listed range for its type.
- **Long:** The weapon is attacking at the listed range for its type.
- **Extreme:** The weapon is attacking at twice the listed range for its type.

### Modifiers

When making your roll, you must add any and all **modifiers** that apply to the combat situation to your final *Attack Roll*. There are modifiers for Target, Aiming, Weapon Type, Type of Firing, Position and Movement, all listed on pg. 99.

### Aiming

One way to improve your chance to hit is to aim. Each turn of aiming adds +1 to your *Attack*, up to three rounds. Aiming assumes steady position, no movement, and a clear chance to track your target.

### Critical Success

On a natural roll of 10, you have had a **critical success**. Roll an additional 1D10 and *add* it to your original roll.

### Fumbles

On a natural die roll of 1, you have **fumbled**. You must roll an additional 1D10 and check the result against the *Fumble Table* (pg. 43) to see what happens.

Fumbles can encompass a wide variety of effects. Most weapon fumbles include jamming or misfires.

**Automatic weapons** have the highest chance of fumbling, and will jam based on

**"Tonight's Body-Lotto scores just in. In the South Side Combat Zone, 13. North Highlands and University District, 4. And this just in—a light plane crash at Night City Metro Airport with no survivors. Winners for tonight are..."**

—Nightly News Program, c. 2020

*"It's not just having an automatic weapon that makes you a hard case. It's knowing how to use that weapon effectively. A good combat gunner can deny an area, rake a group, or put a single round dead on target. And never run out of ammo doing it."*

—Morgan Blackhand

the Reliability of the weapon: When a fumble is rolled while using an automatic weapon, ignore the table on pg. 33, and roll a value on 1D10 higher than the Reliability value for the weapon.

### RELIABILITY TABLE

Weapon	Jams on
Very Reliable .....	3 or lower
Standard .....	5 or lower
Unreliable .....	8 or lower

It takes 1D6 turns to unjam a jammed weapon.

## Automatic Weapons

There are three ways to use automatic weapons. The **three round burst** is used to put multiple shots on a single target at any range. **Full**

**Auto** is used to deliver a lot of bullets at close range to one or more targets. **Suppressive fire** is used to force an opponent to keep his head down or risk taking a slug. Each form has its own advantages and disadvantages in combat, and the smart street warrior knows when to use the right technique for the right job.

### Three Round Burst

The **three round burst** is a setting used on most automatic weapons to conserve ammunition and improve accuracy. The three round burst gives you an automatic +3 to hit advantage at certain ranges. The attack is made as one action. If successful, roll 1D6/2 to see how many rounds actually hit the target. This technique may only be used against single targets.

**3 ROUND BURST= +3, CLOSE & MEDIUM ONLY**

### Full Auto

This attack is best used to cover a wide range of targets or to make sure a single target is dead, dead, dead. A weapon on full auto is a bucking bronco; hard to hold on a target more than a few meters away.

Using a scope or taking aim is also impossible. Therefore, range is critical in the full auto technique.

The **full auto option** is based on the rate of fire (ROF) of the weapon. If attacking more than one target, you must divide the ROF of the weapon by the total number of targets (round down), then roll for each target individually.

### FULL AUTO RULES

#### At Close Range:

*For every 10 rounds fired at Close range, add 1 to your Attack Total.*

#### At Medium, Long and Extreme Ranges:

*For every 10 rounds fired at Medium, Long and Extreme ranges, subtract 1 from your Attack Total.*

For every point of success over the required to Hit roll, one round hits the target, up to the maximum ROF for the weapon.

**NUMBER OF HITS=# POINTS > THAN TO HIT NUMBER**

### Suppressive Fire

**Suppressive fire** is used to cover an area (called a **fire zone**) with bullets, making the area hazardous to pass through. All targets entering or crossing the fire zone during this attack must make a "save" against taking a bullet by rolling their **Athletics Skill+ REF + 1D10** and beating a save number. A failed save means the target takes 1D6 rounds, each randomly located.

This save number is determined by dividing the total number of bullets fired by the width of the fire zone.

*Example: 64 rounds into a 2 meter area would require a save of 32 or higher. 64 rounds into a 5 meter area would require a save of 12 or greater.*

**SAVE= NUMBER OF ROUNDS DIVIDED BY THE WIDTH OF THE FIRE ZONE IN METERS**

You may overlap the fire zones of more than one weapon, dividing the total num-

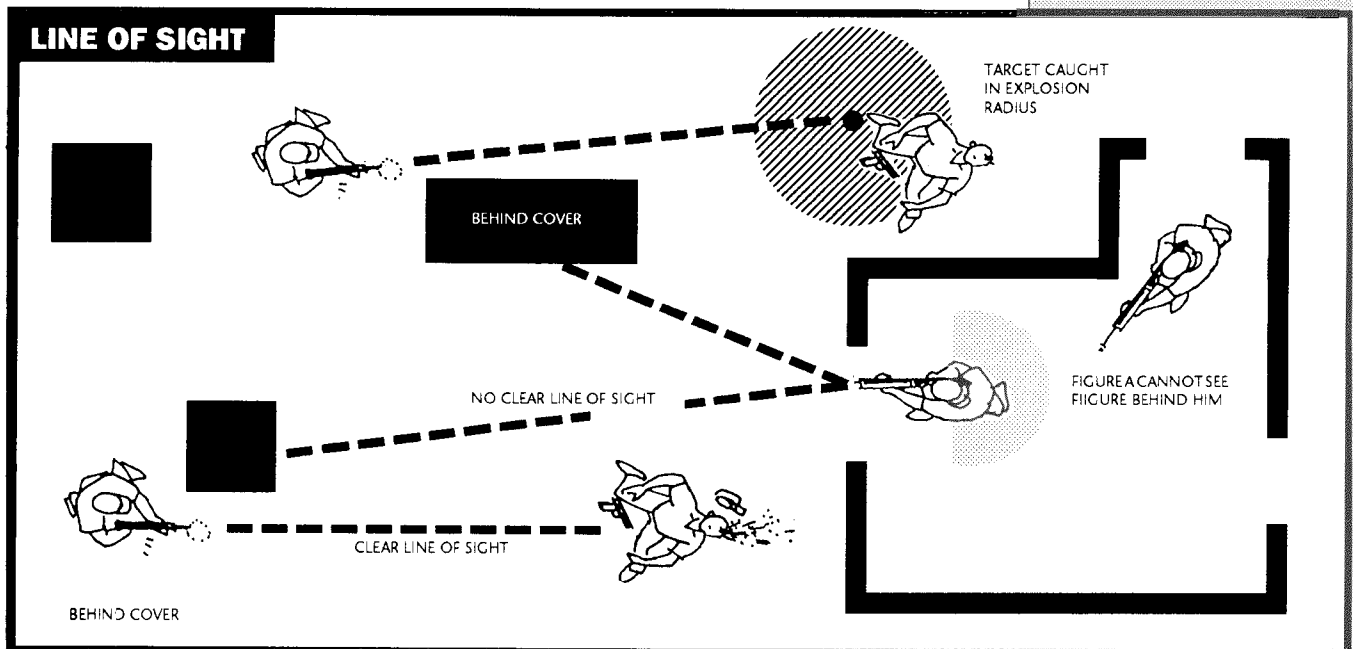

ber of shots to determine the save number. For example, two Uzis with an ROF of 32 would place 64 bullets into the fire zone.

Two rules are immediately apparent with suppressive fire. First, it's only useful when you can fire a LOT of rounds into a small space. This means teams should coordinate their actions and fire at the same time, placing the maximum number of rounds into the fire zone. Also, the fire zone should be as tight as possible (the minimum width of a fire zone is two meters).

## Unusual Ranged Weapons

These weapons are often used for crowd control, stealth missions and other situations where you want killing to be only one of the options, or where you want a limited number of targets eliminated quietly.

### Airguns

These are advanced versions of the "paintball" guns of the 1990's. Airguns can be loaded with poison, marking paint, drugs or acid.

**Paint:** Bruise damage only. Head hits have a 5 in 10 chance of blinding the target for 3 rounds with paint in the eyes, and a 4 in 10 chance of permanently destroying the eye.

**Poison & Drugs:** To avoid the effects, the character must make a save roll. On a successful save, damage is reduced by half.

### DRUG & POISON EFFECTS

Type	Effect	Damage
Hallucinogen	Confusion	-4 INT
Nausea Drugs	Illness	-4 REF
Sleep Drugs	Sleep†	None
Biototoxin I	Death	4D6
Biototoxin II	Death	8D6
Nerve toxin/gas	Death	8D10

†Half effect is drowsiness, -2 to all stats.

**Acid:** Acid causes 1D6 in acid damage per pellet. Although armor will stop this, the acid will eat away at the armor, reducing its SP by 1D6 per round, for a total of 3 rounds.

*Example: Ripperjack hits armor SP 15 with two pellets. He rolls 2D6 for a total of 7 points of damage. The first turn, the armor's SP is reduced to 8. The next turn, it's reduced to 1. The next turn, 6 points get through the armor and sear into the target's skin.*

### Tasers

Tasers require the victim to make a save against stun (see Saves, pg. 104). The save number is reduced by -2 for every successive shot in a three-turn time period. Tasers can be recharged from wall current, taking 1 hour to reach full charge.

### DO UNTO OTHERS, THEN SPLIT

You don't have to tackle that 400 lb. cyberpsycho with a handgun. Get sneaky. Shoot from rooftops, then fade. Use a high powered, scoped rifle to take on that Euro-solo. String some mono-wire at neck height between two posts then bail that Nomad Gang into trying to run you down.

In short, never tackle something head on if you can do it quieter and neater another way.

You Referees paying attention? They're going to use these tricks on you.

Now you're ready for 'em.

### Dart and Needleguns

Dartguns can be loaded with poison or drugs. Each hit does 1D6/2, plus effect of the drug or poison used (see *Airguns*, above).

### Power Squirtguns

Power squirtguns can be loaded with drugs or acids. Effects are as with *Airguns* (above), with each "squirt" equal to 2 pellets.

### Bows, Crossbows, Spears & Throwing Stars

Although they are not common, **bows, crossbows, spears** and **throwing stars** are available in the 2000s. These weapons are either thrown (using the character's *Throwing Skill* for shiriken, darts, knives and spears), or fired (using *Archery Skill*). All non-grenade thrown weapons have a range equal to the thrower's BODx3 in meters.

### Beam Weapons

Beam Weapons include **lasers** and **microwave** weapons. Powerful beam weapons are extremely rare in the *Cyberpunk* universe (1 in 10 chance of availability, and even then only from major Corporations and/or governments).

#### Lasers

Lasers have a rechargeable powerpack holding a total of 10 six sided dice of damage. You can use as little as 1D6 or as much as 5D6 in a single shot, until you have used all 10 dice. Lasers recharge from wall current at a rate of 1D6 per hour.

*Example: Ripperjack has recently captured a laser from an Arasaka guard. He has 10D6 to work with; he dials the power grudge up to 5D6 and fires. At this rate, he'll only have one more shot before it's recharge time.*

#### Microwavers

Microwavers are fired like any other ranged weapon, delivering 1D6 in burn damage. In addition, any target within 1 meter of the path of the beam must roll 1D6 on the microwaver side effects table to determine if there are electrical side effects on exposed cyberwear. Shielded cyberwear is not effected by electrical side effects.

Like lasers, microwavers recharge from a wall socket, taking one hour to reach a usable charge.

### MICROWAVER SIDE EFFECTS

- 1 Cyberoptics short for 1D6 turns
- 2 Neural pulse! If character has inter face plugs, reflex boosts or other hardwiring, REF stat reduced by 1D6/2 until repaired.
- 3 Cyberaudio shorts for 1D6 turns
- 4 Cyberlimb malfunction: Lose all use of cyberlimb for 1D10 turns. Roll 1D6 for limb, re-rolling if no cyberlimb limb is present:
  - 1-2 Right Arm
  - 3 Left Leg
  - 4 Right Leg
  - 5-6 Left Arm
- 5 Total Neural breakdown! Character reduced to twitching, epileptic fit for 1D6/3 turns.
- 6 No Effect.

### Area Effect Weapons

Area Effect weapons are fired just like any other type of ranged weapon. However, they are capable of covering more than one target at a time with a cloud of pellets, flame, explosive force or gas. Area effect weapons include **shotguns, grenades & explosives, flamethrowers, missiles & rockets, mines** and **rocket powered grenades (RPGs)**.

Attacks are made as with other ranged weapons, with the *center* of the area effect falling on the designated target, and anything *within* the area of effect taking damage as well. If the target is missed, the true center of the attack must be determined. When calculating where a grenade or other Area weapon has hit, roll 1D10 to determine the direction on the Grenade Table, then roll a second D10 to see how many meters away it hit.

#### Shotguns

Shotguns fire a cloud of small metal pellets called a "pattern". The width of the pattern is based on the distance between the attacker and the defender. Any target in a straight path between attacker and intended target is also considered to be in the area of effect. Note: if something is between the path of the shotgun and its intended target, the intervening spaces behind that object are considered to be exempt from the effects of fire.



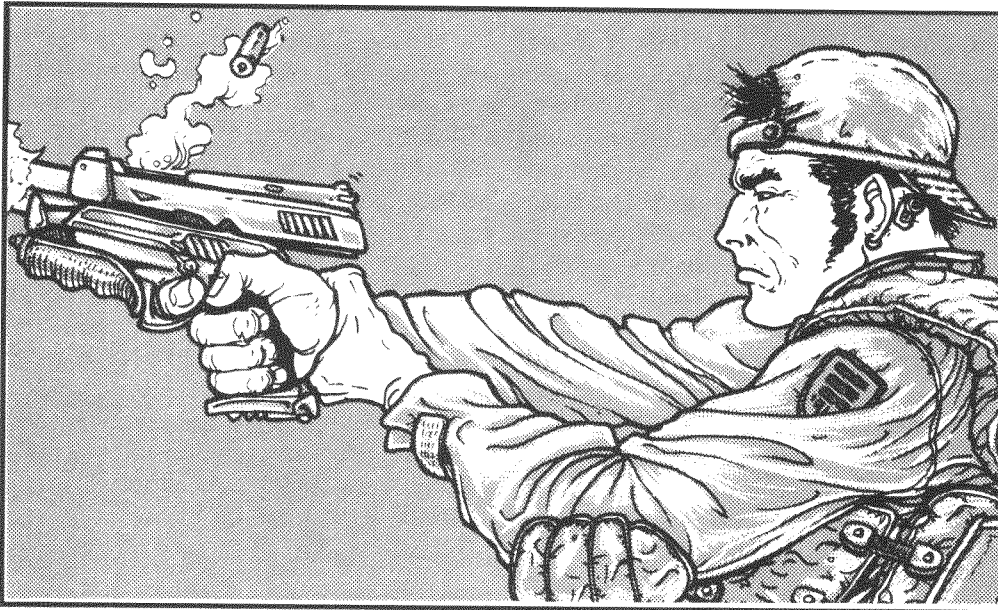

### SHOTGUN TABLE

Range	Size of Pattern	Damage
Close, PB	1 meters	4D6
Medium	2 meters	3D6
Long	3 meters	2D6

Any target within the pattern will take damage based on the range (damage listed on the Weapons Table on pg. 51 is based on maximum damage).

*Example: Ripperjack opens up his shotgun on two boosters at medium range (pattern width=2m). He hits the first booster dead on. However, the second booster is within 1 meter of the first—the pattern overlaps him as well. Both take damage.*

Shotguns are a very effective weapon in situations where aiming isn't critical. For instance, in six foot hallways, there would be no way for a target to escape taking wounds no matter how much his reflexes were boosted. However, shotguns are also limited to relatively short ranges and don't do a lot of damage on the individual pellet level.

**Autoshotguns:** One of the nastiest house to house weapons is the **autoshotgun**. In combat, you may make as many attacks as your weapon's rate of fire on Full auto. All

shots must be within 1 meter of each other. Each attack has a -2 penalty for every additional shot past the first. However, when this means you can put five two-meter clouds of lead all over an area, a -4 or -6 penalty is a small price to pay. Autoshotguns are slow, bulky and have lousy range, but they are hell on wheels when it comes to house to house, short range combat.

*Example: Ripperjack opens up with a CAWS, firing 5 shots. He takes a -8 penalty to his attack roll to do this. He targets a 5 meter hallway, spacing his shots in 1 meter intervals. The hallway becomes Hamburger Heaven.*

### New Rule: The Armor-Piercing Effects of Shotgun Slugs

These projectiles have normal AP ability vs. all armors. Damage that penetrates **Hard** armor is **not** halved. Damage that penetrates **Soft** armor is halved as normal. This represents the concussive results of mass and impact by finned/saboted slugs.

10ga. slugs .....	5d6+3
12ga. slugs .....	4d6+2
20ga. slugs .....	3d6+1

### Grenades

Grenades come in **fragmentation, in-**

### DO UNTO OTHERS, THEN CUT THE CARDS

Always make your enemy play the Game your way. Lure him into chasing you. Pick a place where you can see him coming. Stash some food and ammo for a long stay, if need be.

Smart Punks always have at least a dozen hideouts set up. Don't always go to the same one, or one night, you're going to crawl onto your sleep-mat and BOOM! (See page 100). But make sure you can hole up when you have to.

One slick trick is to bury your best bolthole in the territory of your enemy's worst adversary; say, hiding from Arasaka in the middle of a Militech training camp.

Let *them* do the work.

**"Yo, man, you be wantin' twenty five incendiaries an' a couple o' frags, yeah? No problem."**

### DO UNTO OTHERS, THEN LOOT THE BODIES

Got a team in hot pursuit? Here's a trick. Before you go into the sharp end, plant a few claymores along your escape route. Put 'em under some trash or dirt, and mark the locations with a can or something. When you make your retreat, you dodge the mines and let the lunchmeat on your trail walk the line.

Boom.

Another trick from the School of Low Blows and Assassin's tricks. Got a standoff situation? You can't get them out and you can't get in? Distract them while your mates get to all the doors and windows and set up tripwired claymores. Then, just go away.

Eventually, they'll have to come out.

Boom.

Here's a freebie. Tired of stalking that heavy hitter on the Street? Find out where he sleeps. Put a mine under his mattress

(gently...), then to make sure, tripwire it to one end of the box springs. He'll either sit on it, or he'll flip the mattress back to check for traps.

Too late. Boom.

**incendiary, stun, dazzle, sonic, concussion and gas varieties.** Each type has its own area of effect, usually between 2 to 5 meters. Grenades and explosives can be detonated using timers, radio controls, tripwires or remote detonators. All grenade types are available in hand or rifle-propelled versions, and are described in the **Area Effect Weapons & Grenade Table**, pg. 89. Grenades may be thrown up to 10x the character's Body Type in meters (-10m for every extra kg. past the initial 1), or launched to a range of 225 meters.

**Gas :** Gas differs from other grenade effects in that it moves around. To use gas, first determine the point of impact. All targets within 3 meters are immediately affected.

On the next turn, determine which way the wind is blowing by rolling again on the Area Effect Table. Place the new area of effect. Any target within the first and second areas of effect must save vs the gas, as well as any targets in a straight line the width of the gas cloud between the two points. On the third turn, the gas dissipates.

Gas grenades have either fatal or incapacitating effects. To avoid the effects, the character must make a save; armor doesn't help (although filters or gas masks will). On a successful Save, he will take half effects (a -2 REF reduced to -1, 4D6 reduced to 2, etc.).

### GAS EFFECTS

Type	Effect	Damage
Nausea	Illness	-4 REF
Teargas	Tearing	-2 REF
Sleep Drugs	Sleep†	None
Biototoxin I	Death	4D6
Biototoxin II	Death	8D6
Nerve Gas	Death	8D10

†Half effect is drowsiness, -2 to all stats.

### Flamethrowers

Flamethrowers are much like other area effect weapons, with one difference; they can be "swept" between two points. When using flamethrowing weapons, you may decide both a starting point and an ending point; then roll to Hit, determining if you're on target. Missed rolls refer to the Grenade scatter chart (pg.99). Anything caught in the sweep between the two points is ignited. Using these weapons in anything other than

the cyberweapon form requires the *Heavy Weapons Skill*; cyberweapon flamers use *Handgun Skill* as the default. Damage is 2D10 the 1st turn, 1D10 and 1D6 the following two turns. Hard armors protect normally. Soft armors must be >15SP to protect the target, and are damaged 2pts/hit.

### Mines

Mines come in two types; standard land mines and "claymore" antipersonnel mines. A **land mine** is designed to stop vehicles or other heavy objects; it is easily detected with most magnetic sensors (7 in 10 chance). You step on it and it blows up. Simple. Damage is 4D10.

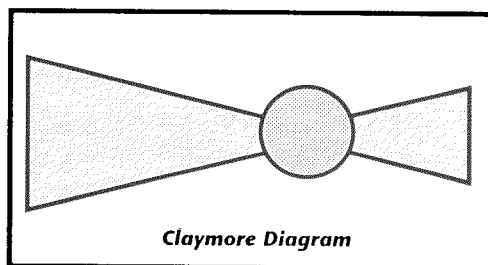

A **claymore** is designed to stop *people*, not vehicles. Claymores can be triggered by tripwires, time delays, or remote switches. Claymore mines have an hourglass shaped area of effect, rather than a circular one (see illustration). The dimensions of the "front" cone of destruction are 6m wide by 75m long; the dimensions of the "rear" cone of destruction are 6m wide by 6m long. At the juncture of the two cones is a 6 meter wide circle. Damage is 4D10.

### Rocket Powered Grenades

**Rocket Powered Grenades (RPGs)** are a hybrid of grenade and rocket projectile, with far greater range and accuracy. They are also easier to acquire than missiles. With the exception of the disposable Armbrust RPG, most have the disadvantage of backblast, making them impossible to fire in a confined space. RPGs are fired as with other grenade launchers or shoulder arms, using the character's *Heavy Weapons Skill*. Damage is 6D10.

### Missiles

Missiles and Rockets include radar and optically guided missiles, mini-rockets and shoulder rocket launchers. Using missiles

requires use of the *Heavy Weapons Skill*. When firing missiles and rockets, treat them as rifle-fired grenades with longer ranges and larger areas of effect. Damage varies.

**Note for Rockets and Missiles:** If a rocket or missile has an Armor-Piercing warhead, the armor's SP is halved, but the damage that penetrates is not.

## Explosives

Explosives vary from grenades in that the more you use, the bigger the blast area. Explosive amounts are defined as units; one unit of TNT would equal one stick; one unit of plastique would be an ounce, etc.

### EXPLOSIVE RANGES

Explosive	Unit	Area	Damage
Plastique	1kg	4m	7D10
C6	1kg	5m	8D10
TNT	1stick	3m	4D10

Take the area covered by one unit of explosive and multiply this by the total number of units. Damage is applied to the overall body, rather than to a location.

*Example: Ripperjack lumps four sticks of TNT together and tosses them into an abandoned building 10 meters away. One stick has a blast area of 3 meters—4x3=12 meters. Ripperjack is caught in his own explosion and takes big damage. Bad move, 'Jack.*

## Molotov Cocktails

Molotov cocktails are the favorite of would-be terrorists and people with a lot of gasoline, rags and empty bottles around. A molotov covers 2 meters for every liter of fuel used (a standard soft drink bottle would cover 2 meters). Damage (2D10) is applied to the overall body, rather than to a location.

## Melee Attacks

Melee attacks include **clubs, knives, swords, axes, chainsaws, sledgehammers, monokatanas and monoknives, monomolecular chains, cyberbeasts, battlegloves, rippers, scratchers, martial arts weapons, hand to hand attacks and brawling.**

Melee attacks differ from ranged attacks in that you are opposing a person, instead of a

target. To make a melee attack, the formula is:

**ATTACKER REF+SKILL+1D10**  
**VS**  
**DEFENDER'S REF+SKILL\*+1D10**

\*Martial arts, Fencing, Melee, Dodge or Athletics can be used, depending on situation and Referee decision.

## Martial Arts & Brawling

**Brawling** and **Martial Arts** attacks are different from other melee attacks in that an attack can be made in a number of ways. You could, as an attack, use:

- **Strike:** Cause 1D6/2+ Damage Modifier.
- **Kick:** Cause 1D6+Damage Modifier.
- **Block/Parry:** Stop or absorb damage.
- **Dodge:** -2 to Attacker's hit roll.
- **Disarm:** On successful roll, knock or remove weapon from opponent's hand.
- **Throw:** Requires a Grapple first. Opponent is knocked to ground, taking 1D6+Damage Modifier, plus making a stun roll at -2.
- **Hold:** A painful joint or body hold. You must Grapple your opponent first. Foe is immobilized until an escape is made.
- **Escape:** On successful roll, you are free of the hold and may move.
- **Choke:** Requires hold or grapple as the previous move. Opponent takes 1D6 damage per turn.
- **Sweep/Trip:** Knock opponent to ground. He is -2 to next his attack; you gain +2 to your next attack.
- **Grapple:** A grabbing or holding move, prerequisite to applying a throw, choke or hold as the next action.

**Martial Arts:** Martial Arts are traditional forms of melee combat that have been developed to be deadlier than regular brawling. All martial arts techniques have **key attacks**—attacks which reflect the particular strengths of the technique. When a key attack is used, such as a karate kick, the character gains an +2 to +4 attack bonus (depending on the style of martial art).

For example, *Karate* would have the following moves:

*"I didn't have time to draw my gun. But I did have time to snap a wheel kick into his face, followed by a spinning crescent off the back heel. That took him down long enough for me to get the Minami out of my armor-jacket.*

*"Good thing too— his partner was right on me with a backfist and a hand-strike combo. All of it pure chipped skills. Too bad for her— a 10mm slug at hyper-velocity beats kung-fu any day..."*  
—Morgan Blackhand

- Strike .....+2
- Block/Parry .....+2
- Kick .....+2

A *Karate* Master would be able to do any other type of move, but would be better at these three.

A Master of *Choi Li Fut* would have:

- Strike .....+2
- Block/Parry .....+2
- Kick .....+2
- Throw .....+1
- Dodge .....+1

—making him far more versatile than our *Karate* Master.

Of course, it would far more difficult to learn *Choi Li Fut* than *Karate*; this is reflected in the **difficulty level** of the form. The number of Improvement points normally required to increase your level of skill is multiplied by the difficulty level to show this. A full list of martial arts, difficulty levels and key attacks is on pg. 100.

**Damage:** In addition, martial arts are far more deadly than regular brawling. When using martial arts, you will gain a damage bonus equal to your current level of martial arts in addition to any strength bonuses.

### Dodging

Defenders can try to **dodge** melee attacks by announcing their intention to dodge at the start of the turn. This will impose a -2 attack penalty to any attacks made against them in that turn; however, any other actions the defender makes will have a corresponding -3 penalty for each successive action.

**DODGE=-2 TO ATTACKER  
ROLL, -3 TO DEFENDER'S  
OTHER ACTIONS**

### Parrying

Defenders may also elect to **parry** melee attacks by announcing their intention to parry at the start of the turn. Any attacks made during the turn must expend their damage against the parrying object first.

**Swords** and other bladed weapons can be used to parry *without* taking damage, but

must make a save (9 or lower on 1D10 for normal weapons) to avoid breaking. Any other actions the defender makes will have a corresponding -3 penalty for each successive action.

**PARRY= STOPS THE ATTACK AT  
-3 TO DEFENDER'S OTHER  
ACTIONS**

### Melee Damage

When making melee attacks with weapons, the damage is listed as part of the weapons description.

When making a melee attack, you must also add a damage modifier based on your character's body type to any damage. This damage modifier is listed in the **Damage Modifier Table** below.

### DAMAGE MODIFIERS

<b>Strength</b>	<b>Add to Damage</b>
Very Weak .....	-2
Weak .....	-1
Average .....	+0
Strong .....	+1
Very Strong .....	+2
Body Type 11-12 .....	+4
Body Type 13-14 .....	+6
Body Type 15+ .....	+8

### Monoknives, Monokatanas and Slice & Dice

**Monoknives, monokatanas** and **Slice & Dices** do double damage on a natural attack roll of 10. These weapons will always break on a fumble (a natural 1), and require a special roll to determine if they shatter when used to parry (4 or less on 1D10). Unless otherwise noted in the weapon's description, all mono-edge weapons are at 1/3xSP vs. soft armors, 2/3xSP vs. hard armors.

### Cyberbeasts

"Cyberbeast" is the popular term used to describe any cybernetically controlled weapon that is stored in the body and yet has the capacity to attack on its own. Cyberbeasts may make one attack per turn. They have a **total attack skill of 10+1D10**; in all other aspects, they attack as characters would. The most common type of cyberbeast is the **cybersnake**, which cause 1D6 in damage per attack.

# Vehicles In FNFF

Vehicles involve two elements. The first is control of the vehicle; the second is attacks and damage. Although a more realistic system is included in *Solo of Fortune*, this simple system will work for most cases.

**a) Making a Control Roll:** To control a vehicle you must roll a combination of your

**REF+DRIVING/PILOTING SKILL+1D10+ MODIFIERS**

equal to or greater than a specific control number. The control number is determined by the difficulty of the maneuver you want to perform.

**Simple** (swerve, take off or land, hover, rotate)..... 15

**Difficult** (tight turn, control a skid, recover from a stall, emergency stop, pull out of dive, reverse or pull away) ..... 20

**Very Difficult** (bootlegger turn, regain control from spin) ..... 25

**b) When making your roll:** you must add any and all modifiers that apply to the situation to your final Control Roll. There are modifiers for both vehicles and speed of travel:

### CONTROL MODIFIERS

- Standard car ..... -0
- Limousine ..... -3
- Sportscar ..... +2
- AV-4 ..... -2
- AV-6 ..... +2
- AV-7 ..... +1
- Motorcycle ..... +1
- Truck ..... -4
- Rotorcraft ..... -0
- Osprey ..... -0
- Boat ..... -1
- Double safe speed ..... -2
- Triple safe speed ..... -4
- Four times safe speed ..... -6

On a failed roll, roll 1D6 and consult the **Control Loss Table** below:

### CONTROL LOSS TABLE

Roll	Result
1-2	Skid or slew; no other result.
3-4	Major skid; slide 1D10x10 feet sideways in direction of travel. Aircraft stalls, losing 1D10x50 feet of altitude.
5-6	Roll ground vehicle after sliding 1D10x10 feet sideways in direction of travel; take 5D6 damage. Aircraft goes into spin, lose 1D10x100 feet of altitude .

### Vehicle Combat

Vehicle combat is performed exactly as with other combat, applying all appropriate modifiers, and using the Weapon Skills appropriate for the type of weapon. Shots are not targeted and there are no location for damage. Vehicles are usually armed with lasers, missiles, machine guns and railguns, and may receive bonuses for turret mounted weapons.

### Vehicle Damage

Vehicles have both SP values and **Structural Damage Points (SDP)**. If armored, the vehicle's SP is subtracted from the damage taken, with the remaining damage subtracted from the vehicle's SDP.

When a vehicle is reduced to 0 SDP, it is considered to be destroyed or inoperable. In this simplified system, there are no locations for damage—all points are subtracted directly from the vehicle's SDP.

### Crashing & Ramming

Crash and ram damage is determined by dividing the speed of the moving vehicle by 20 (round down), to determine the number of six-sided dice thrown. This value is multiplied by a modifier based on the mass of the object collided with, listed in the **Weight Modifier Table** below. The vehicle takes this many dice in damage to its SDP, while all occupants take one-half of this die amount.

### WEIGHT MODIFIER TABLE

Size	Multiplier
Very Light (small box, feathers) .	x.5
Light (man, large box) .....	x1
Medium (motorcycle) .....	x2
Heavy (car) .....	x3
Very Heavy (truck, ground) .....	x4

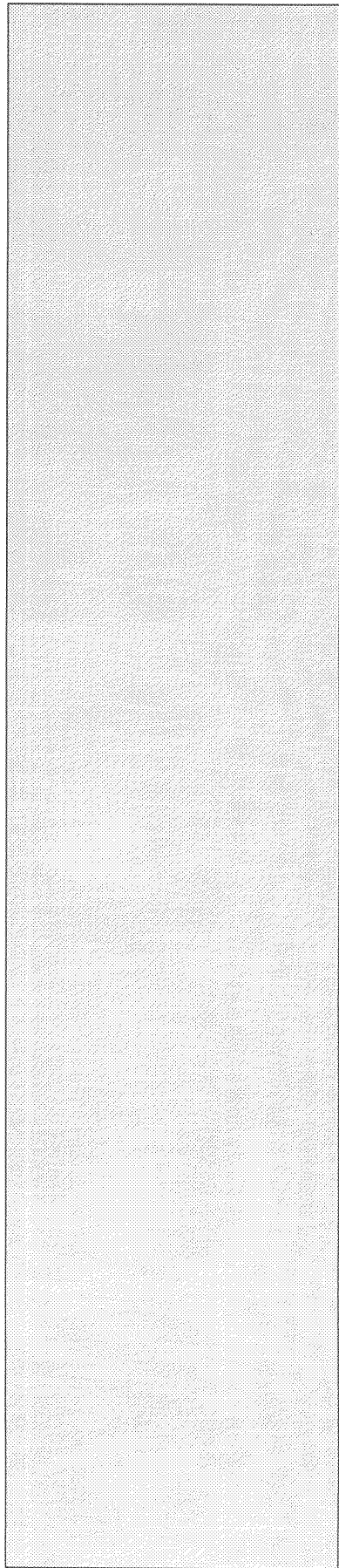



**ROLES**  
**CHARACTERS**  
**LIFEPATH**  
**TASK & SKILLS**  
**WEAPONS**  
**ARMOR**  
**GEAR**  
**CYBERWEAR**  
**COMBAT**  
**MEDICAL**  
**NETRUNNING**

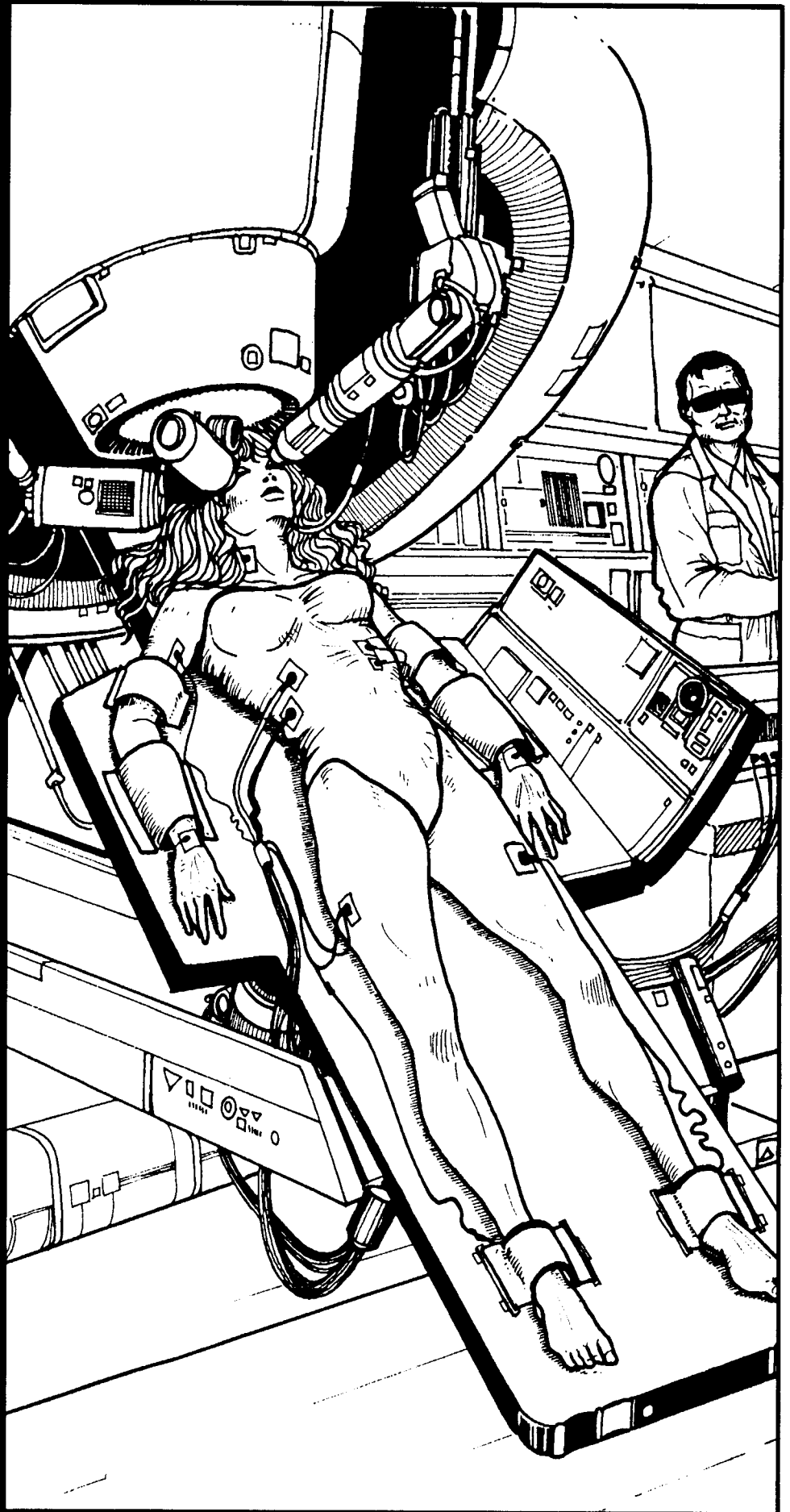

**Face it; you don't need to know a lot about the medical technology of the 21st Century. You need to know what to do when you're bleeding to death in a dark alley somewhere.**

## SECTION 8 TRAUMA TEAM

**So let's look at the most important question first—is this guy going to survive or should we call Savage Doc's and arrange for a body pickup?**

### Death

Whenever a character's Wound State drops to MORTAL, he has a pretty good chance of dying. But when? In *Cyberpunk*, each time you are at a MORTAL wound state, you must make a Death Save to avoid dying. To make the Save, roll a 1D10 value lower than your character's Body Type, subtracting the level of Mortality from your base chance to save. Each turn, you must make another death save to see if the character makes it through another turn. On a successful roll, you make it; on a failed roll, you will die at the end of the turn in which the roll was made.

*For example, say Savage has a Body Type of 10 (Very Strong) and takes a Mortal 4 wound. He must roll lower than  $(10-4)=6$  to stay alive. The first turn he rolls a 5. Whew. The next turn, he rolls a 7 and expires. Immediately, his mates start fighting over who gets his boots.*

Get the point? Sooner or later, you'll fail a roll and die. The only way out is **stabilization**.

Stabilization means the patient is no longer losing blood and that his major damage has been contained through use of drugs, battlefield surgery, and/or wound dressing. A stabilized character will no longer be required to make Death saves each turn. Anyone (except the patient himself) can attempt to stabilize a mortally wounded character; it just works better if the physician has had some medical training. A lot better.

### VERY IMPORTANT

A Trauma Team will always arrive within 1D6+1 minutes of your call.

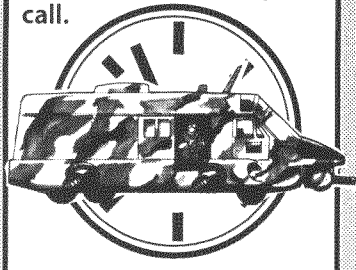

### HEALING RATES

Treatment	Pts./day
First Aid .....	0.5
Medical Tech .....	1
Med Tech+Speed Heal .....	2
Med Tech+Nanotech .....	2
Med Tech+Nano +Spd. Heal .....	3

A successful stabilization is made by rolling a total of your TECH stat, any Medical Skill and one D10 for a result equal to or higher than the total number of damage points the patient has taken. *For example, Savage has taken 20 points of damage, placing him in a Mortal 1 Wound State. To stabilize him will require a roll of 20 or greater.* Once stabilized, the character is no longer in danger of dying unless another wound is taken. At that point, the whole messy business begins again...

The chances of a successful stabilization roll can be increased by the following modifiers, added to your die roll.

Advantage	Add to die roll
Full Hospital & Surgery .....	+5
Trauma Team Ambulance .....	+3
Cryo Tank .....	+3

### Death State

But let's say *your* ripperdoc had a Medical Tech Skill of 2...

We can do some pretty amazing things these days. We can grow skin, blood, organs, limbs and muscle tissue in collagen-saccharide tissue tanks. Other parts, like toes, fingers, eyes and internal organs can also be purchased from the local Body Bank and grafted on with advanced microsurgery. What we can't do is regrow souls. Once you're dead, you're dead.

Let's amend that: once you're DEAD 10, you're dead. Because twenty-first century medicine is so good at reviving the clinically dead, Trauma Team™ Inc. (the world's largest paramedical service, with offices worldwide), has established ten levels of death, each succeeding level a measure of how difficult it will be to revive the patient. This measuring system is called Death State. For every minute (six turns) that you are clinically dead, your death state increases by two levels. *Example: I am killed at 9:00. Three minutes pass before the Trauma Team™ AV-4 arrives. I am now at Death State 6.*

This is of critical importance to the dead Cyberpunk character. When the Trauma Team arrives, a roll must be made to deter-

mine if the patient can be revived. This roll, on 1D10, must be higher than the current Death State number, or the patient is a candidate for the Body Bank. On a successful roll, the patient is stabilized at his last Wound State and the process of healing can begin.

## Healing

Okay, so you're not on a slab in Savage Doc's place...

In order to recover from damage, characters must make some type of medical skill check. Otherwise, the patient continues to take damage (from infection and system shock) at the rate of 2 points per day. If the patient is at a Mortal Wound State, he must make a daily Death Save as well as taking this damage. Without medical aid, you're going to run out of luck pretty soon. This is probably why humans invented medicine in the first place.

To make a successful medical skill check, you must roll a value (using TECH, your medical Skill and 1D10) greater than the total number of points of damage the patient has taken. Medical skill checks are made with two skills, *First Aid* or *Medical Tech*.

### First Aid

*First Aid* involves cleaning and dressing the wounds, administering medication, setting broken limbs and putting on splints. When a character makes a successful First Aid skill check, the patient will recover at the rate of 0.5 points per day. *Example: A Light wound would be healed in 8 days. A Critical wound would heal in 24 days, a Mortal 3 wound in 56 days.* Only one check need be made. You may (within reason and at Referee's discretion), perform first aid on yourself. On an unsuccessful roll, the patient regains no points. New attempts may be made once per day until a successful roll is made.

### Medical Tech

*Medical Tech* skill assumes that the character has studied medicine in a professional setting. This gives him the ability to perform surgery, prescribe drugs, and know the proper treatment of injuries. He can

replace damaged organs with vatgrown pieces, graft on new limbs, or install cyberlimbs. You cannot perform Medical Tech skills on yourself.

A character with *Medical Tech* skills makes a check as if using the *First Aid* skill, however, with *Medical Tech*, the patient will recover at the rate of 1 point per day. For example, a light wound would be healed in 4 days. A Mortal 3 wound would heal in 28 days. Using *Medical Tech* skills supersedes the use of *First Aid* skills; a patient on which both have been successfully performed regains points at the rate of 1 per day, not 1.5! As with *First Aid*, the patient regains no points until a successful roll has been made. However, second attempts may be made once per day until a successful roll is made.

### Speed Healing Drugs

Drugs can be used to speed the healing rate by 1 additional point per day. Expensive and often proscribed, these drugs have a neural side effect of reducing the patient's REF stat by 1D6/3 for a week after use. *Speedheal* costs 1650eb per treatment.

### Nanotechnology and Tailored Antibodies

Nanotechnology involves the use of incredibly tiny, psuedo-organic machines to perform minute surgical tasks. These tiny tools can be programmed to repair damaged cells with molecule-sized polymer threads, or to act as temporary bridges between mutilated nerve endings.

Combined with tailored antibodies, nanotech devices can speed healing to twice the normal rate (patients recover 1 point per day in addition to normal healing). A Light Wound for example, would be healed in two days, while a Mortal Wound 0 would completely heal in eight days. When combined with speed healing drugs, this rate is increased to 3 points per day, allowing the same mortally wounded character to be back in action in an unbelievable six days!

Here's the catch. Besides being expensive (1500 eb. per treatment) nanotech is avail-

able only in certain hospitals (1 in 10). But if you've got the money, it's the best option for getting back on the Street fast.

### Being Patient

The first thing to remember is that after a *First Aid* or *Medical Tech* roll is made, the patient *still* has to actually recover (this isn't a fantasy game where a magician can lay on hands and the gutshot victim springs up ready to tackle the next challenge). Each Wound State imposes certain limits on the character:

**Light Wound:** The patient is fully ambulatory; he can go about his business with a minor amount of pain.

**Serious Wound:** The patient is ambulatory, but will need his dressings changed once a day, and will be at -2 REF for all actions.

**Critical Wound:** The patient must spend at least half of his day in bed in order to regain any lost points of damage. Other activities must be limited at simple tasks, at a -4 REF to all actions. Dressings must be changed twice a day, and nursing care of some sort must be available.

**Mortal Wound:** The patient is bedridden. At Mortal Wounds 3 and above, he is probably comatose (50%) most of the time, and wired into all kinds of machinery for life support. He requires constant care during the entire process, although he will not have to make *Death Saves* (he's been stabilized).

### A Sample Medical History

Ripperjack takes a gunshot wound (25 points total) to the gut, reducing him to Mortal 3. His partner has a high *First Aid* skill and makes a *Stabilization* roll to save him. So far, so good.

As soon as Ripperjack is stabilized, his partner calls in the Trauma Team™. Four minutes later, the AV-4 touches down. The Trauma Team™ Medic makes a *Medical Tech* check on Ripperjack. The roll is successful. The Team takes 'Jack to Night City General Hospital and checks him into Emergency.

"You got a slice in the belly—that's a Light Wound. You got a ten-inch wedge taken out—that's a Serious Wound. You got your guts spillin' out in Techniholo all over the pavement—that's a Critical Wound.

"Anything worse than that, you're just Spare Parts waitin' for a Trauma Team pickup..."

—Ripperjack

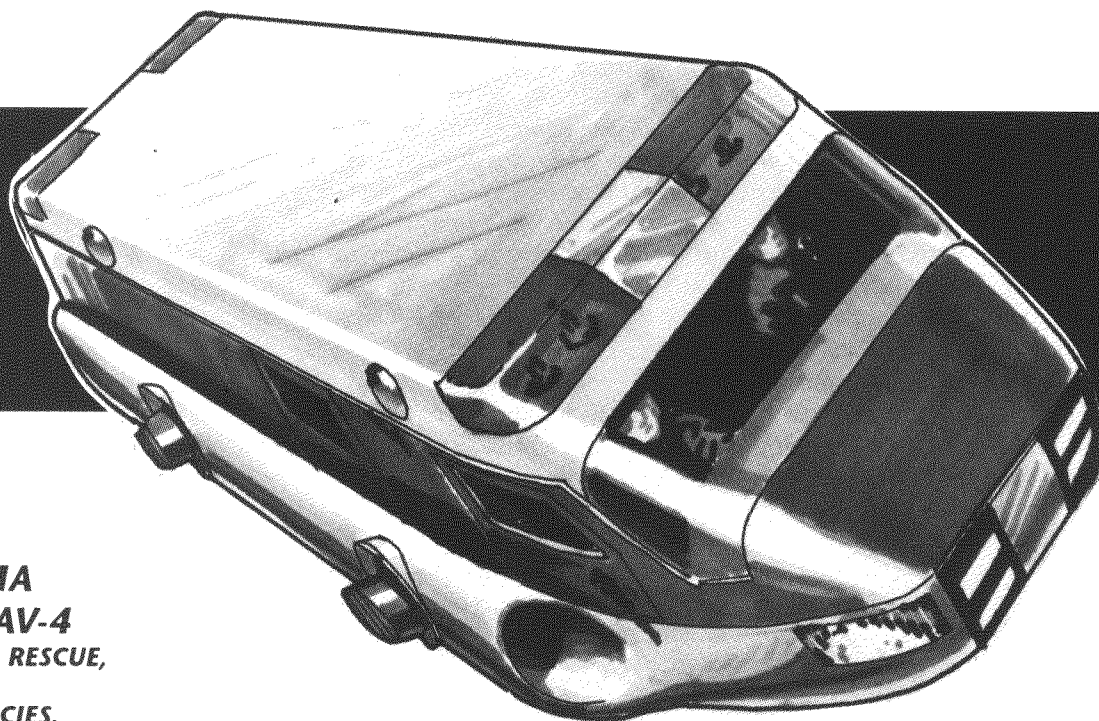

**TRAUMA  
TEAM AV-4**  
USED FOR RESCUE,  
MEDICAL  
EMERGENCIES.

As a Mortal 3 patient, it will take Ripperjack 13 days to recover enough to reach a Critical Wound state. During this time, he will be in a hospital bed, wired to life support, and out of it on drugs (when he reaches Mortal 2, the doctors can take him off the drugs and life support). At Critical, Ripperjack is able to hobble around the ward for a couple hours at a stretch, while the nurses look after him. In 4 more days, he's able to leave the hospital as long as he gets his dressings changed once a day. In 4 more days, he's nearly up to full function. It's taken him 21 days to get back on the Street. Now he can start earning enough money to pay off his medical bills.

### **Elective Surgery**

Not all medical care is the result of accidents or combat. This is the Metal Age, and when you want to get cybered up, you gotta pay a price in blood.

If you're going to get wired with a cyberlimb, the first thing you'll have to decide is whether you want to keep the meat one. For 100eb a month, a Body Bank will store your old one until you decide to reclaim it, with only a 20% chance that someone will sell it for spare parts in the meantime. For

200eb a month, this drops to a 5% chance; not perfect, but better than nothing.

Now you've ditched the old meat in the freezer, it's time to get cybered up. A Medical Tech skill is required to install cyberwear. You can't install cyberwear on yourself. Each type of cyberwear has a **Surgery Code** (pg. 75). This code represents the minimum level of medical care required to install the cyberwear, the length of surgical time required, the cost of the surgery, the damage taken in surgery and the Difficulty of the installation procedure. The Surgery Code assumes that a successful *Medical Tech* check has been made on the patient as part of the operation. Healing is then based on the number of points lost due to the surgery.

### **Negligible**

Required: Mall clinic or other drop-in bodyshop.

Surgical Time: 1 hr.

Surgical Damage: 1 point

Surgical costs: Included with installation.

DIFF= Easy (10)

### **Minor.**

Required: Medical center or ripperdoc clinic.

Surgical Time: 2hrs.



Surgical Damage: 1D6+1  
Surgical costs: 500eb  
DIFF=Simple (15)

#### MAjor.

Required: Full hospital with surgery center.  
Surgical Time: 4 hrs.  
Surgical Damage: 2D6+1  
Surgical costs: 1,500eb  
DIFF= Trained (20)

#### CRitical.

Required: Full hospital with surgery center.  
Surgical Time: 6 hrs.  
Surgical Damage: 3D6+1  
Surgical costs: 2,500eb  
DIFF= Difficult (25)

*Example: Morgan Blackshadow decides to get a cyberarm installed.*

*The surgery code is Critical (CR). Morgan takes 11 points in surgical damage (Wound State=Critical). The surgery is Difficult (25), requires a hospital, takes six hours and costs 2,500 eb. It will take Morgan 11 days to recover fully, but he can be back on the street in a week (operating at a Light Wound State).*

#### Replacement Surgery

Remember; arms and legs don't grow back. Even if you heal, a missing limb will still be missing. You can chose to replace it with something out of a Body Bank or vat, or you can go for the metal. Replacing a limb with either requires a CR surgery code. A replacement meat arm will cost about 1,000 eb. A replacement cyberarm starts at 2,000eb and goes up from there depending on what you want to plug into it.

## Trauma Team Inc.

One of the most powerful Corporations of the Cyber Age is the Trauma Team™; a bonded and licensed paramedical franchise operating throughout the U.S., Canada and

parts of Europe. These crack ambulance units are specifically designed to get to the scene of a fatality within seven minutes (or your money back).

Trauma Team's crews are made up of the best paramedical techs and staff available. The teams are usually made up of a driver, a senior Medtechie, an assistant and two security officers. They normally travel in a heavily armored AV-4 aircraft, supported by mobile tanker trucks and ground refuelling stations. A Trauma Team AV-4 contains the most sophisticated revivification and life support technology available, including a mobile cryotank to lower the body temperature to approximately 24 degrees F, (the optimum temperature to prevent hemorrhaging, shock, and brain swelling).

**A Trauma Team pilot is skilled enough to set a six-ton AV-4 on top of a parked car if need be... Meanwhile, the security team secures the area using the AV's twin autocannon, while the medtech gets the body on board...**

Trauma Teams™ can be summoned by dialing 911 on any phone, and are equipped to trace the origin of any phone call to its source. (You're billed from the moment you call, until delivery to the Hospital.) You may also opt to carry a deadman transmitter, which will activate and automatically signal a Trauma Team the moment your brainwave pattern falls into a coma state. The most common

transmitter is in the form of a plastic credit card, which is activated by bending the card in half, and has a range of 20 miles. Trauma cards can be transferred between members of a group as long as the card's owner is present to sign the charges off when the Team arrives.

There are usually a dozen or more Trauma Teams on call at any time in a major city. Immediately after receiving an alert, the nearest Trauma Team™ unit goes airborne, their sophisticated tracking equipment homing in on the last known location of the patient. The pilot (who is skilled enough to set his six-ton AV-4 on top of a parked car if need be), drops in as close as possible. If the firefight is still going on, the security team secures the area (using the AV's twin autocannon or their own portable weap-

*"I've been in Trauma Team for five years now. I've put my bus down on more rooftops than I care to remember, and I've been in more firefights than I ever was during the Wars. By now, I don't even see the bodies as people. I see them as either parts or pickups."*

—Unknown

ons). The medtechs load the patient on board, shunting his life support to the on-board heart-lung machines, plugging him into onboard biomonitors, and chilling his body down in the refrigerated tank for stabilization. Rapid surgery is performed on the spot for the most critical wounds, while the med specialist uses a combination of electroshock, drugs and manual resuscitation to get the patient on-line again. The pilot slams down the throttles and the AV-4 rockets skywards on a pillar of exhaust, headed for the nearest emergency room. The entire process may have taken all of four minutes from start to finish.

As a privately owned concern, Trauma Teams™ are not under any obligation to transport a casualty to a hospital, although they are responsible for reviving and stabilizing critically wounded patients. Trauma Team fees are exceedingly steep (\$100 per minute), the best method of offsetting their exorbitant costs is to either carry Trauma Team services as part of a Corporate group insurance policy, or to establish an account with TT International, paying a premium of \$500 in advance each month for continued service.

### Spare Parts

These are places where you can get the raw materials for putting people back together again. They are a staple of the Cyberpunk landscape, and a good source of steady income for the enterprising street dweller.

### Body Banks

Just in case it didn't work out, you can still make a dead comrade pull his weight. The Lifeline Act of 1994 (an extension of the donor cards of the 1980s) allows a potential source of spare parts to carry a donor card in his wallet. This card must be registered with the federal government. Only donor carded bodies can be turned into a donor center, where a bounty is paid. The bounty is based on the parts involved and the body condition at the time.

Part	Average Bounty	Sale Price
Arm	500	1000
Leg	600	1200
Heart, Lung	700	1400
Liver, Kidney	200	400
Eyes, Ears	800	1000
Other Organs	200-300	400-600

Poor Condition: 1/2 normal bounty

Excellent condition: 2x normal bounty

The Government doesn't care who turns the body in. All you need is the card and a legitimate death certificate stating that the deceased died of natural or accidental causes, available through any local coroner. The result is that many firefights end with a frenzied looting of bodies for donor cards—followed by another firefight over disputed claims and ending in another frenzy of looting.

Legally, donor centers must be located in legitimate offices of the County or City Coroner's Office, or in a public hospital. However, a thriving black market in fraudulent donors thrives in most of the combat zones, usually out of "ripperdoc" clinics or Corporate centers (where high level execs get first pick of the new parts).

The biggest problem with Body Bank replacements is the availability of genetically matching parts. When attempting to locate a replacement limb or other part at a body bank, roll 1D10. On a 1,2, or 3, the part is unavailable that day. On a 4 or 5, the part is in, but it may be the wrong color or have some other minor difference.

### Vat Grown Tissue Banks

This reflects recent (2017) improvements in genetic technology. Using tailored DNA and cell-growth vats, legs, arms, organs and other parts (including exotic designs like animal-human crosses) can be grown to order. Unlike bodybanking, vat-grown parts are available to match any genotype. However, the process is relatively new and is more expensive than simply using an arm off the rack (2 times the price for a similar body bank part in Excellent condition).

## Bodysculpting

As long as you're having a few cybernetic grafts put on, why not go all the way and re-do the whole thing? The art of bodysculpting includes skin tints, hair and eye color changes, breast enlargement and reduction, and general all-over bodywork. You can have bone and muscle removed to become shorter, or have grafts added to become taller. Excess fat can be suctioned away, and collagen implants can smooth wrinkles, add weight, and change contours. Bodysculpting is readily available in

a number of body salons, including Bodyshoppe, Parts N' Programs, and Docs R Us™. Body sculpting includes appearance changes, appearance enhancement, and exotic fashion.

**Change Appearance:** Looking like a favorite movie star or celebrity is a popular fad in 2020; entire gangs, known as Posers, often have themselves bodyshaped to resemble famous people. Appearance changes are also a staple for Solos, Rockers, and any other sort of high mover who needs to change identities often. The cost of an appearance change is based on how convincing that change is.

At 1,200 eb, you look sort of like you wanted to; a casual observer could spot the difference on an AVERAGE Notice check.

At 2,400 eb, you look very much like you wanted; it would take a DIFFICULT Notice check to spot the sculpt job.

With 3,600 eb, you would look exactly as you wanted to look; spotting the sculpt would take a VERY DIFFICULT Notice check.

At the top end (5,000 eb), it would require a NEARLY IMPOSSIBLE check to spot the body-sculpt from your original face.

**Increase Attractiveness:** *Cyberpunk* style always goes to the extremes—you're either really ugly or very good-looking. One way to increase your Attractiveness is to have your body re-designed at the local 'sculpt clinic. The process is expensive, granted, but many people think having the right "look" for that year is worth a few thousand euro. Cost is 600eb per Attractiveness point gained. *For example, to raise my appearance four points would cost 2,400eb.*

Want to decrease your Attractiveness? A straight razor costs fifty-nine cents.

### Exotic Fashion

Body-sculpt jobs that emphasize the alien or inhuman are known as **Exotics**. Vat-grown tails, furred skins, hooves, animal-like faces and ears, cats eyes and other semi human features are the highlights of this style. Exotic fashion is incredibly expensive, time consuming and usually a hobby



among only the very rich and very bored. Prices are based on the individual enhancements.

**Facial Sculpts** combine vat-grown parts such as muzzles, whiskers, animal-like ears, manes and cat eyes with the patient's normal features. There are entire booster-gangs based around various animal motifs of this type. Cost: 5,000eb

**Tails** are grown in vats, using gene bank tissue. They can be furred, tinted, scaled or bare skin. The tail is grafted to the base of the spine and linked to the nervous system by nanotech nerve threaders. Tails are relatively weak; they can pick up about a half pound. Cost: 3,000 eb.

**Hooves, claws and paws** can be grafted to replace normal feet and hands. They are not as dexterous as normal digits (-2 to REF), but are occasionally included as part of a Exotic body-sculpt. Cost: 8,000 eb.

**Skin alteration** uses transform DNA to change the structure of the patient's skin. Using tailored DNA, the skin can be induced to grow patterned fur, light scales, or exotic skin colors. The big drawback is a 1 in 10 chance that the graft will mutate and develop into skin cancer. You get to pick the number. Cost: 10,000eb.

*"I want my legs lengthened and my hips angled. You can pull the stretch marks out of the tummy while you're at it. Don't forget to resize the breasts and widen my shoulders a tad...Now, about the tail..."*

*—Conversation at the local Bodyshoppe*

### SECTION

# 9 DRUGS

**Question:**  
What's a  
Cyberpunk  
game with-  
out drugs?

**Answer:**  
A lot  
healthier.

The drugs of the future are far more lethal than their 20th century counterparts. Many are experimental chemicals dumped on the Street by unscrupulous Corporations looking for guinea pigs. Some are home-brewed horrors designed in basement labs. Still others are military-designed combat drugs designed to create armies of zombie killing machines. All of them are bad news.

Most of the drugs in *Cyberpunk* are addictive—the people who designed them were looking for a way to create a captive market of addicts. Only the very wealthy can afford to have non-toxic "designer drugs" created for their own physiologies; most of the scum on the Street (the rest of you) are left sucking up the dregs of the chemical sewer.

Common street drugs include:

#### **SynthCoke**

Type: Stimulant                      Strength: +1  
Difficulty: 20                              Cost: 1000  
Duration: 1D6+1 minutes

The second generation, synthetic replacement for cocaine. Like the original, its side effects are nasty: paranoia, psychological addiction.

#### **Stim**

Type: Stimulant                      Strength: +3  
Difficulty: 10                              Cost: 500



#### **Duration: 1D6+1 minutes**

Stim increases endurance, allowing the user to stay alert for longer periods. Side effects include mental delusions.

#### **Syncomp 15**

Type: Antidote                      Strength: +3  
Difficulty: 13                              Cost: 650  
Duration: 1D6+1 turns

Syncomp is a broad spectrum poison antidote, used to treat nerve and biotoxins. REF is reduced at the rate of 1 point per dose.

#### **Speedheal**

Type: Healing Drug                      Strength: +2  
Difficulty: 33                              Cost: 1650

**Duration: 1D6+1 hours**

Speedheal (described on pg. 107), is designed to enhance the natural healing processes. Side effects are reduced REF by 1D6/3 for a period of 1 week after use.

**Boost**

**Type:** INT Booster      **Strength:** +4  
**Difficulty:** 12      **Cost:** 600  
**Duration:** 1D6+1 hours

Boost increases INT by +1 for a 2-7 hour period. A Boost addict has gained full tolerance—his INT is no longer increased, and he must have more Boost within twelve hours or be reduced to screaming fits and hallucinations.

**Blue Glass**

**Type:** Hallucinogenic      **Strength:** +1  
**Difficulty:** 18      **Cost:** 900  
**Duration:** 1D6+1 minutes

Blue Glass was originally developed as a biological weapon. Under stress, you will have a 3 in 10 chance of "flashing out"—reduced to staring blankly at the pretty colors in your mind (reduce INT by 1 per dose). Roll 1D10 and hope.

**Smash**

**Type:** Euphoric  
**Strength:** +1  
**Difficulty:** 2  
**Cost:** 100 per 6 pk  
**Duration:** 1D6+1 minutes  
Smash is 2020's answer to alcohol—it's yellow, foamy, and comes in cans. It makes you loose, happy and ready to party. The downside is that when it wears off, its psychological addiction component makes you suicidal. If you fail your addiction Save, you sink

into total catatonia; a feebly mumbling ball of pain—a ripe target for some Booster looking for spare change.

**'Dorph**

**Type:** Pain Negation      **Strength:** +2  
**Difficulty:** 5      **Cost:** 250  
**Duration:** 1D6+1 turns

Designed as a combat drug and painkiller, endorphins reduce pain and stress effects. 'Dorph allows you to reduce the effects of stun or shock. Dorph also has a nasty cost in nervous system damage. Each time you use 'dorph, roll an additional 1D10. On a 1, you have lost 1 point of REF—permanently.

**Black Lace**

**Type:** Pain Negation      **Strength:** +3

**Difficulty:** 13**Cost:** 650**Duration:** 1D6+1 hours

A high powered version of 'Dorph which imparts euphoria, adrenal rush, and invulnerability to pain. Your CL is raised by 2, and you are resistant to stun or shock effects. Lace is deadly. Lace users become fearless, cold-blooded killing machines—exactly what its military designers were looking for. If you fail your addiction save (1D10 roll higher than Body Type) roll an additional 1D6 and subtract the result from your EMP stat. Treat the result as if suffering from cyberpsychosis. If you go over the line, too bad. Roll up another character.

**Remember:** Drugs are dangerous. Mess with them and you'll probably kill your character. Or at least mess him up beyond repair. The choice is yours.

Just like real life.

## Building Your Own

Although drugs are bad news, they are a prominent theme of the cyberpunk genre. It stands to reason that sooner or later, enterprising Referees (or players) may want to unleash their own biochemical horrors on the world. As any fan of *Miami Vice* (or a player who watches a lot of real life cop shows) can tell you, drugs

are a great way to get people fired up on the streets with lots of automatic weapons; in short, the perfect "McGuffin" for a mean, nasty, lowlife adventure.

The drugs given here are only examples; it's a good idea for Referees to build any new ones before introducing them into gameplay. Drug building requires a *Pharmaceuticals* Skill check against the DIFFICULTY of building the drug. To determine this value, you must first check the Effects Table below and choose what effects you want the drug to have. Add the total DIFFICULTY values together to arrive at a Base Difficulty for that drug.

**Drugs are a great way to get people on the streets with lots of automatic weapons; the perfect "McGuffin" for a mean, nasty, lowlife adventure.**

**"He said, 'I've got over 1,500 units of Chloramfetaphene coming in tonight with the Salazar Gang. I want it protected. You protect it, and I'll cut you in for 10% of the take.'**

**"So I said 'No.', shot him through the head, and turned the shipment data over to NCPD.**

**"My sister died of an OD, and I'm touchy about drug dealers..."**

**—Unknown**



*"You won't feel a thing...Except good..."*

—Unknown

*"In a surprise press conference today, Biotechnica announced the release of its new genetically-coded designer drug series. Guaranteed to provide maximum pleasure with minimum risk, the new complexes are..."*

—Night City Today  
May 16, 2020

*Nothing's free. And if a Corporation made it, the hidden costs are double..."*

—Unknown

### EFFECTS TABLE

DIFF	EFFECT
15	Increase REF by Strength of drug.
15	Increase INT by Strength of drug.
15	Increase CL by Strength of drug.
15	Enhanced Perception (+ Strength to Awareness checks).
15	Increase healing rate 1 point per point of Strength.
15	Antidote (+1 to Save per Strength)
10	Increased Endurance (+ Strength to Endurance checks).
10	Negate Pain Effects(+ Strength to Stun Saves).
5	Depressant (-Strength to Awareness).
5	Euphoric (makes you feel good)
10	Hallucinogenic (makes you see things).
10	Reduce Stun (+ Strength to Stun Saves).
5	Soporific (-Strength to Save vs. Sleep).
10	Aphrodesiac (-Strength to resist Seduction checks).
10	Contraceptive (male or female)
10	Antibiotic (+ Strength to Saves vs. disease).

### Strength

Strength is the power level of the drug. The higher the Strength of the drug, the greater it's plus or minus effect on the body. Drugs come in strengths from 1 to 3. Add the Strength of the Drug to its Base Difficulty.

### Side Effects

You can buy down the cost of a drug by buying **side effects**. These are bad things that balance out the beneficial side of the drug (for example, if cocaine wasn't psychologically addictive and didn't cause delusions, it would be everything Sigmund Freud thought it would be). You may never buy a drug's Difficulty costs below 2.

**Psychological Addiction (-8pts):** The character is psychologically addicted, and must roll lower than his CL each hour following the last dose of the drug. On a failed roll, he suffers extreme anxiety, fear and depression; he become driven to find more of the drug and can do nothing else. Kicking the addiction is a VERY DIFFICULT Endurance check, and may take as long as the Referee decides is sufficient.

**Physiological Addiction (-10pts):** The character is physiologically addicted, and must roll lower than his BT each hour following the last dose of the drug. On a failed roll, he will suffer intense pain and take 2D6 in damage until he can kick the habit (a VERY DIFFICULT Endurance check, taking as long as the Referee decides is sufficient).

**Death (-15 pts):** The drug has a fatal component that can kill the unwary. Each time the drug is taken, a Death Save must be made with a negative modifier equal to the drug's Strength number minus one.

**Reduced REF (-5pts):** The drug reduces REF at a rate of 1 point per dose for the duration of ths dose. If a new dose is taken before the last has worn off, the REF penalty is cumulative.

**Reduced INT (-5pts):** The drug reduces INT at a rate of 1 point per dose for the duration of the dose. If a new dose is taken before the last has worn off, the INT penalty is cumulative.

**Tremors (-2pts):** The drug causes painful tremors in the hands, face (-2 to REF).

**Hallucinations (-5pts):** The drug causes hallucinations (colors, voices, strange shapes). The character is virtually unable to function normally. If you buy this as a side effect for a hallucinogen, the character will always have a really bad trip that is totally at the Referee's sadistic discretion. You Have Been Warned.

**Paranoia (-3pts):** The character is subject to paranoid delusions; he thinks "they" are after him, etc. (although in *Cyberpunk*, this may not all be delusion). The character must drop everything and devote his actions to defending himself against "them". Who "they" are is, of course, up to the Referee.

**Delusions (-5pts):** The character is subject to strong delusions; he thinks untrue things are real, that aliens are talking to him, etc. The character must drop everything and devote all actions towards the maintenance of his delusion. Which, again, is up to the Referee.

**Sterility (-8pts):** The drug causes permanent sterility on a 3 in 10 chance.



**AIR HYPODERMIC**

*Also known as the "Bones McCoy", the airhypo is used to dispense drugs of various types.*

**Carcinogenic (-10pts):** The drug causes cancer (3 in 10). If cancer is developed, the character will take 1 point of permanent damage unless a cure is effective (a VERY DIFFICULT Medical Tech check) or he dies.

**Psychotic Rage (-10pts):** The drug causes the character to fly into a psychotic rage, attacking anyone within range.

**Aggressive Behavior (-12pts):** The drug causes the character to become irritable and aggressive. On a 5 in 10 chance, he will pick a fight with the nearest person to him.

**Irrational Fear (-12pts):** The drug causes the character to become inordinately fearful of everything. He must drop everything and cower in near catatonia until the drug wears off.

**Nerve Degeneration (-15pts):** The drug

causes severe nerve damage (-2 REF lost permanently).

**Duration**

Drug durations vary from dose to dose, situation to situation. When a drug is taken, roll 1D6+1 to determine the total amount of time the drug will remain active in the system:

- 1D10+1 turns ..... x1
- 1D10+1 minutes ..... x2
- 1D10+1 hours ..... x3

Multiply the total DIFFICULTY (BASE + STRENGTH, minus SIDE EFFECTS) to determine the final Difficulty of creating the drug.

**Cost**

Per-dose cost is determined by multiplying the Difficulty level of the drug by 25 euro. *Example: Sindementaphilinine has a Difficulty of 26. Its street cost would be 650eb per dose.*

**ROLES**  
**CHARACTERS**  
**LIFEPATH**  
**TASK & SKILLS**  
**WEAPONS**  
**ARMOR**  
**GEAR**  
**CYBERWEAR**  
**COMBAT**  
**MEDICAL**  
**NETRUNNING**

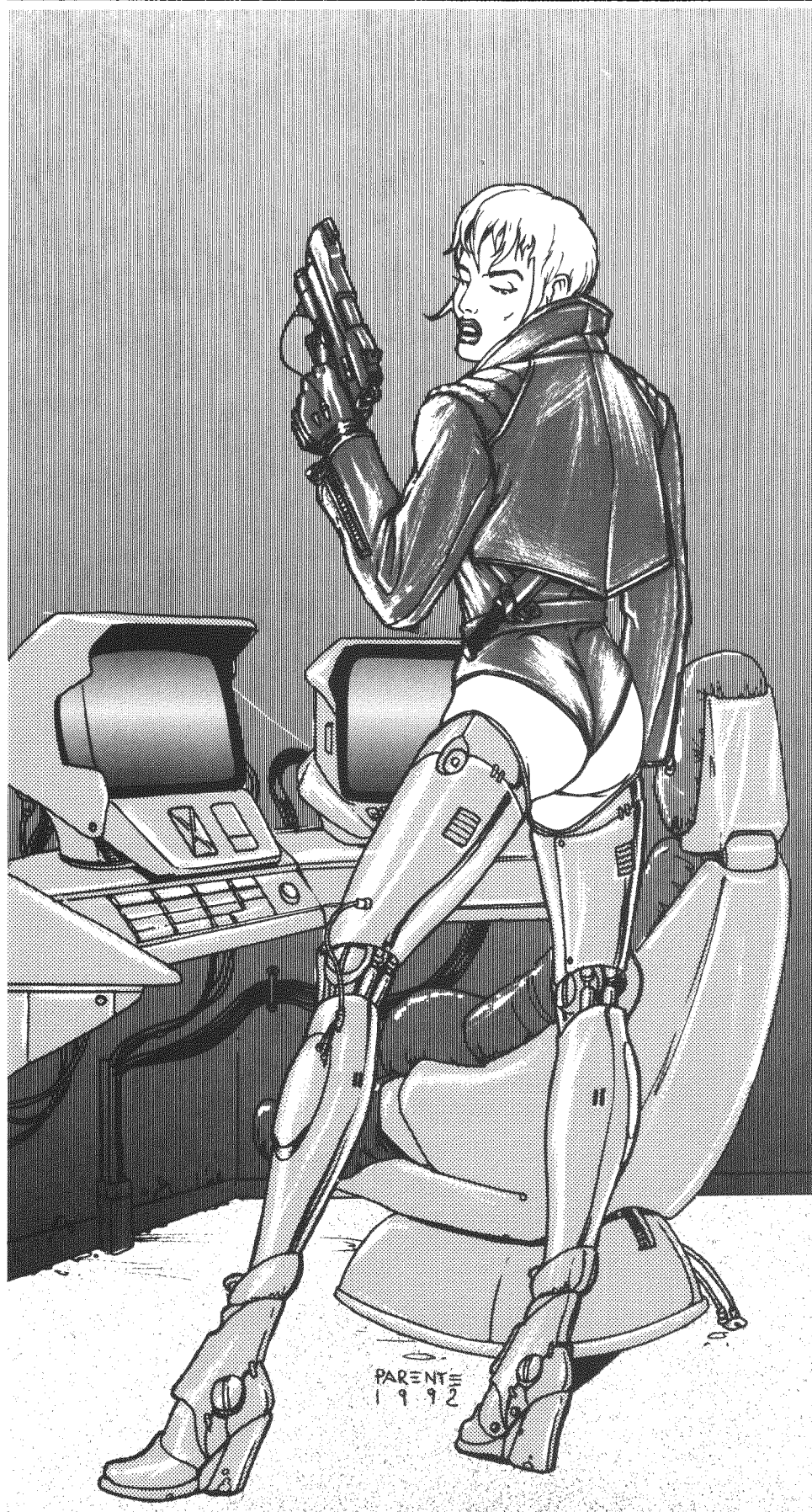

## SECTION

## 10

## NETRUNNER

*You patch in the last connection, making sure your wristplugs are tight. You slam down the "GO" switch. Instantly, your mind is filled with the grey white static of the drop to "on line." Then, with a sickening, falling sensation, your hurtle forwards into a maze of shifting neon shapes and spinning grid lines.*

**You're in the Net.**

The Net is a vast telecommunications network that joins all of the computers and telephones on Earth. It is formed by radio, telephone, and cellular phone links, with microwave transmitters beaming information into orbit and beyond. In the late 20th century, the Net was only accessible via a computer terminal, using a device called a

modem to send and receive information. But in 2020, the Net can be entered directly, using your own brain, interface plugs, and complex interface programs that turn computer data into perceptual events.

**Netrunners**

Netrunners are outlaw computer jocks who are advanced versions of the computer hackers of the late 20th century. Netrunners operate on both sides of the complex and draconian laws covering computer-crime in the *Cyberpunk* world. Hard driving computer cowboys, Netrunners literally take their lives into their hands as they tackle the mighty data fortresses and the deadly counter-intrusion programs that guard them—the ultimate challenge of Man vs. Machine.

Some people do it for glory, or because it's there, but most run the Net for money. Inside each computer system linked to the

*"Frack, she was good. She was the best. Maybe it was because she'd been a combat programmer during the Third Corp War, or maybe it was just a gift.*

*"I always figured it was because of the accident—the one that took off both legs and part of one arm. With all the cyberwear, there wasn't much left that was human. My guess was, she only came alive in the Net. Everything else was just marking time in a half alive body.*

*"Great lookin' half- alive body, though..."*

*—Edger*



**"There's over a dozen Netrunners out there that the Netwatch Cops would love to brain-burn. And Rache Bartmoss is at least two of them..."**

—Spider Murphy

**"Gawd, but it's great to be loved..."**

—Rache Bartmoss

Net is information. Some of the information is trivial and useless, like recipe lists or notes, but much of the information is incredibly valuable. New business plans. Insider stock tips. Secret blueprints. Black-mail information. Hot new programs and software. Money you can transfer electronically to your own bank accounts. The formula for Coke Classic. Even if you can't use what you find, you can usually sell it to a Fixer who will in turn sell it to someone who can.

Another reason people run the Net is to back up other *Cyberpunk* teams. If you need to send someone into a heavily secured installation, the installation's computer may have maps of the entire place. Once inside, you can use that same computer to override security systems, open computer controlled doors, even eavesdrop through computer controlled security cameras and observation devices. Most heavy duty Solo teams have at least one 'Runner on the payroll, just to gather intelligence about secure areas and obstacles to a battle plan. Corporations also hire Netrunners to protect their computer systems and to commit their own corporate computer espionage.

The laws of the 2000's are extremely draconian about computer crime. Most government agencies can freely use any and all means to eliminate intruders. Most Corporations are equally hardline (except with their own pet 'Runners). Even without resorting to highly illegal black programs, the law allows Corporate authorities to locate and arrest intruders on the spot. Heavy prison terms and possibly mindwipe are just samples of what awaits a computer felon.

But you're not planning on getting caught, right?

### Net Geography

The Net is basically a vast "potential space" constructed by linking together phone lines and fiberoptic control cables. The **Ihara-Grubb Transformation algorithms** that govern Net reality generate this space as a "wire-skeleton" topography of grids and shapes. Areas of high line resistance (old lines, garbled transmissions), appear as "mountains", while areas of low line resistance appear as plains and valleys. Individual computer systems appear as ICONS or constructs created from millions of tiny "bits" of color and light, which, like video images or halftone photographs, can only be distinguished as individual parts by close examination. To simplify navigation

through Netspace, the actual communications lines of the Net are represented as an endless blue-white grid. When an individual line must be located, programs within the Netrunner's cyberdeck locate the required lines or access points, and identify them with a bright red beacon light.

The Ihara-Grubb Transformations are also designed to take the relative

position of a system into account in relation to its contiguous Netspace. For example, a computer system high in a skyscraper will appear as an icon far up in Netspace. A system buried underground will be positioned roughly as in relation to the plane of Netspace as it is relative to the ground level in external reality (or Realspace). Both systems can be found in a Netspace location analogous to their real locations in their individual subgrids. A moving system will travel through the subgrids that are parallel to its travel in Realspace.

Any place a computer can be turned on and hooked into the NET is an extension of the NET into this universe. The Net is, as far as anyone can tell, potentially infinite—if you can link a computer to this communications web, you will automatically create

**"An Alien race could infiltrate the Net through space. Some cowboys think it's already happened..Me, I got doubts... But I also got a laser just in case"**

—Edger



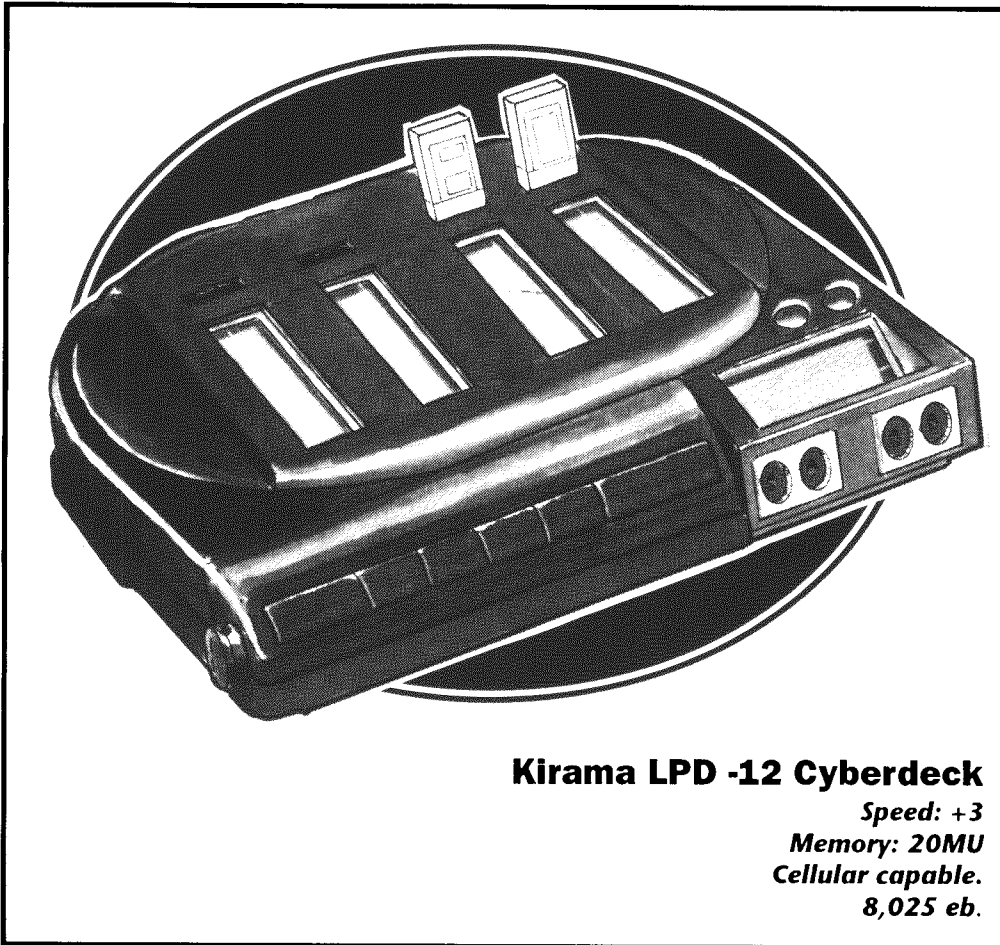

### Kirama LPD -12 Cyberdeck

*Speed: +3*  
*Memory: 20MU*  
*Cellular capable.*  
*8,025 eb.*

a new section of the Net around that computer. Thus, new areas are created all the time, as more computers are hooked up and logged onto the Net.

Theoretically, you could put a radio/Net link into a long range spaceprobe and extend the Net into deep space. But it would take a loooooong time to get to that area of Netspace, and it would take forever to do things. Ihara and Grubb theorized that an alien intelligence with a lot of power and a knowledge of Earth computer-tech could link to the Net over interstellar distances. Probably, it could not actually do anything; the best solution would be to beam a link to an orbital satellite, downloading a copy of the alien AI into the Net at this end, then move freely about the Net.

Some Netrunners claim this has happened already.

## Islands of the Net

### People, Places and Things in Netspace

#### Regions

**Regions** (also nicknamed "kingdoms"), are large areas on the world NETmap (such as *Atlantis* in the southern Atlantic/African Basin). They are referred to by **name**. A Region is a hazy zone of shifting boundaries; new regions pop up all the time, and the boundaries constantly change as potential Net reality shifts. It's not really a *place*; just a rough definition of an area where certain groups or governments have the most control. Regions include:

**Atlantis:** This is the second largest of the regional kingdoms, stretching from Central and South America to the west coast of Africa. The region is primarily controlled by the Central American Federation and its al-

*"Boy, I wish ol' Bill Gibson was around to see this!"*

*"Hey, Edger. Don't you know it's unlucky to invoke the name of the Patron Saint?"*

*—Somewhere over the Pacifica Region, LDL 2542.0219*

*"Pacifica... Floating islands of light, capped with neon green fractal palm trees. The whole thing floats above a bright, glittering ocean, like something out of a tropic dream."*

*"They've got the virtual water construct set up so that you can see all the way down to a limitless seabottom, where glowing colory fish shapes dive between shifting mirage coral., pursued by clever dolphin programs, part AI and part illusion."*

*—Rache Bartmoss.  
Net Traveller's  
Guide, 2019*

lied corporations. Key City Grids are located in Mexico City, Panama City, Bogota, Havana, Rio de Janeiro, Buenos Aires, Dakar and Acension. Atlantis is a fairly freewheeling region, with a lot of blackmarket trade, especially out of Panama City.

**Rustbelt:** This region covers the Central and Eastern United States. Key City Grids are the New York/BosWash Megaplex, Chicago-GreatLakes, Atlanta-CityCore, New Orleans, and St. Louis. The region is a near absolute dictatorship controlled by a troika of NetWatch (the worldwide Net security organization), the U.S. Provisional Government, and the EuroMarket Consortium. Systems are heavily monitored and computer crime treated with draconian ferocity.

**Olympia:** The Olympia Region spans most of the Southwestern and Western United States. Nominally, it is the domain of NetWatch and the United States Provisional Government. Individual city grids are usually controlled on a local level by the most prominent Corporation in the area; Denver (Orbital Air), Salt Lake (Militech), Dallas/Houston Megaplex (WorldSat), Albuquerque (Militech). Most of the traffic in these regions is corporate related, with many established bulletin boards and service networks.

**Pacifica:** This is the largest of the regions, covering the West Coast of North America and expanding over most of the Pacific Basin. As with Olympia, it is under the joint rulership of NetWatch and the USPG to the edge of the Hawaiian Basin; at this point, there is a four way division between NetWatch, USPG, Arasaka LTD and the Far Asian Co-Prosperity Federation. In the US, most key City Grids are controlled by the most powerful corps in the specific city; Night City (Arasaka), San Francisco (EBM), Los Angeles (Petrochem), Seattle (Arasaka). In these cities, control is relatively loose. Across the Pacific Basin, control increases as Arasaka tightens its grip.

**TokyoChiba:** This is a very small region covering the Japanese archipelago, specifically Tokyo, Osaka and Yokohama. Chiba is the center of operations for a number of very powerful zaibatsu, including Mitsubishi-Dai, Matsushima-Kiroshiu, and of course, Arasaka. However, due to the immense amount of inter-zaibatsu warfare, no one megacorp holds control, making this a ripe field for information brokering and corporate "netspionage".

**Afrikani:** This regional "kingdom" extends from the edge of Atlantis across Africa to the

Middle East and Madagascar. Key City Grids are Addis Ababa, Zanzibar, Cairo, Algiers, Nairobi, Mozambique and Alexandria. With the exception of Nairobi and Cairo (under firm Orbital Air control), the rest of Afrikani is a chaotic wasteland of antiquated systems, shifting alliances and fanatics. Caution is advised.

**EuroTheatre:** This most powerful of the regional "kingdoms", EuroTheatre is primarily controlled by the EuroCorps. Key City Grids are London, Paris, Berlin, Frankfurt, Munich, Zürich, Amsterdam, Rome, Madrid and Stockholm. The three largest EuroCorps in each city work in cooperation with NetWatch to maintain security. The EuroTheatre Net is dominated by corporate traffic; there are few private systems and most independent Netrunners are already known and recorded by NetWatch. EuroTheatre is a good place for legal business transactions, banking, Netconferencing and other legitimate transactions. It is a very, very bad place to commit computer crime.

**SovSpace:** This region covers the borders of the now reduced Union of Soviet Socialist Republics, extending into Eastern Europe. Key City Grids are Moscow, Leningrad, Warsaw, Kiev, Budapest, Vienna, and Prague. The USSR holds nominal control over this region, with control gradually shifting to NetWatch and the European Economic Community around Poland. Systems in SovSpace tend to be primitive, slow and equipped with a few deadly programs rather than sophisticated defenses. The Eastern European netrunners range from simple hackers all the way to the most daring cowboys in all Netspace (these guys have nothing to lose). The entire region is rife with espionage, information trading, and the petty bickerings of small political groups looking for their own economic advantages. A good place to sell information, if you don't mind being paid in low value currency.

**Orbitsville:** The largest potential region, covering the Low Earth and Near Earth Space. Orbitsville is a great place to meet people, pick up rumors and generally have a good of time. Security is loose to nonexistent. Orbitsville is primarily controlled by the Orbital Corporations and the ESA (which has it's own version of NetWatch). There's not a lot of "groundhog" traffic—orbital time lag (2-3 seconds) makes Netrunning from Groundside a tough proposition. Local traffic is very busy, with every Spacer habitat and colony hooked up to a constant stream of chatter. Transactions are mostly on the small time level: trading raw materials, medicine, air, food, water and gossip.

## Long Distance Links

Long Distance Links, (LDLs) allow instantaneous transfer between cities. The world wide Internet Communications Corporation maintains most of the available Long Distance Links as part of its long distance services, but many large corps have private Long Distance Links that go only between corporate offices.

Using a Long Distance Link requires a password (normally the Netrunner's Net Access code, which is used for billing purposes). However, with the right programs, one can convince a Internet that *this* call is a local one, or that the call was never actually made.

## Wilderspace

Movement between Long Distance Links is almost always done via up/downlinks. Most of the physical space is "jumped" over, and is pretty much unknown territory. Yet, the activation of individual computers can create independent areas not directly linked to the Net. The intervening distances between physical points of the Net (such as San Francisco and Night City) are called *Wilderspace*. Wilderspace was originally theorized in 2004 by J.A. Grubb, a computer game designer and occasional hacker who conceived of it as a vast area of dormant, potential reality, which could come into existence when a computer was linked to the Net. Without up/downlinks, this region would be isolated from the main traffic of the Net, and accessible only by those who were willing to "walk" there the hard way.

Netrunner legend is that "something" probably lives in Wilderspace: rogue AIs, alien intellects, things which have their own separate "citygrids" that only appear occasionally when these forces open an up/downlink to the main Net. The equivalent would be a remote South Seas island which is unknown and unreachable, until a canoe is sent to the nearest civilization. If the natives were skilled at entering civilization and disguising their true nature, they could probably remain undiscovered for centuries.

## NetWatch

NetWatch is a policing organization

designed to patrol the Net looking for illegal activity. Governments, individual corporations and other large groups contribute money, equipment and their best Netrunners to the NetWatch organization. The NetCops are equipped with very powerful software and move freely through the Net, patrolling a specific "beat" that may cover a city, Region or even a continent.

NetCops (Wolves, Weasels, The Icemen) are equipped with very powerful tracking programs, as well as "arrest" programs that can freeze a cyberdeck in a "loop" and hold the Netrunner frozen, unable to jack out until released. While arrest and imprisonment are the goal of the NetCops, they have been known to use black programs to kill or maim their opposition.

## Bulletin Boards (BBS)

A BBS is a friendly Data Fortress where Runners can meet to exchange information, chat, swap software and so on. A BBS Data Fortress is usually heavily protected and hidden somewhere. A code word or very complex encryption is needed to get in. Once inside, the BBS user encounters a number of "areas" or "clubrooms" designated for various functions. These are usually designed around thematic virtual realities. For example, the *Hunt Club* BBS of Denver is an elaborate virtual reality construct of a grand old English manor house, complete with servants, a drawing room and a croquet green.

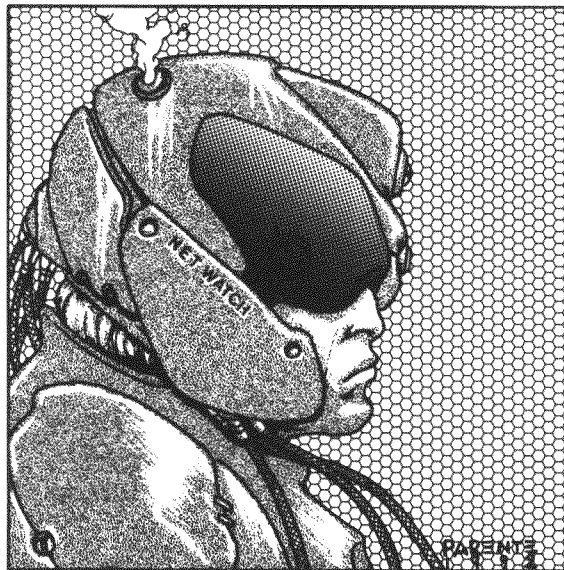

*"NetWatch was created as part of a unilateral agreement in the UN treaty. It is empowered to protect and serve the law abiding citizens of the World Communications Network...."*

—*The Netwatch Story*  
A DMS Production

*"NetWatch. A buncha hoods with cyberdecks who like to push people around. We like to lead the Icemen into deserted regions of Net Space and dry gulch 'em. And not just for the fun of it..."*

—*Rache Bartmoss*

## NetGear

### Interfaces

The human mind can't comprehend a stream of data any more than it can "see" an electron. It needs a way to interpret the incoming data as something meaningful. So Netrunners use an **interface program**—a super-advanced version of the more primitive "virtual reality" systems of the 1990's—to interpret for them. The interface intercepts data coming through the cyberdeck and translates it into something understandable—then routes the altered data to the Netrunner's eyes and ears. The world perceived through the interface is real, because it directly plugs into his senses.

So why go through all the trouble to create interfaces? Why not just use a keyboard like the rest of the meat minds? Partially for the fun of it. But in addition, a realistic and dangerous interface gives the Netrunner an extra edge. It keeps him alert, involved and interested in his environment. After all; what would you react faster to—the word *Demon* appearing in the air in front of you, or a living, breathing, five-ton monster cracking a flaming whip over your head?

You betcha.

### The Second Generation

The early interfaces were an art form; millions of programming hours were devoted each year in constructing accurate and interesting realities for Netrunning, using sophisticated artificial intelligence programs and random story generators. These interface programs functioned on a low end, narrow focus bandwidth, which could not carry much more information than an old fashioned computer modem of the 1990's. In addition to being limited in scope, these early interface programs were also unable to give the Netrunner a sense of his position in the real world beyond the computer screen.

Then, in 2014, the wizards of the Net achieved a major breakthrough—the Ihara-Grubb Transformation Algorithms. The I-G Transformations allowed a cyberdeck to extrapolate the pathways of the Net in relation to their "Realspace" coordinates, then generate a graphic model that could

be perceived by an interface program. The results could be used as a navigational aid through the Net, as well as providing a sense of space and time not possible with earlier designs.

### ICONS

One of the other benefits of the I-G Transformations are that they allow you to translate the signal of your cyberdeck into a visible representation in the Net. This representation of yourself is known as your **ICON**.

Most things in the Net have some kind of **ICON**; even if one isn't specified, the I-G formulas will create a polygonal form to represent them. Your **ICON** is your personal symbol; it's what other Netrunners will talk to and relate with when they encounter you in Netspace. Your **ICON** can look like anything you want it to: armored technowarrior, fantasy creature, bizarre shape or logo— even yourself. You can change your **ICON** any time you enter the Net. You can even disguise your **ICON** by using special programs for stealth and evasion. Choosing your **ICON** is one of the first things you'll decide when you jack in. Make sure it's got your personal style written all over it.

### Interface Plugs

So what do you need to run the Net besides a cool brain and a hot interface? Plugging into the vast metaverse of the Net requires two additional and all important pieces of hardware.

The first is a set of neural or interface "plugs." Interface plugs are basically just that—plastic plugs built into the Netrunner's wrists, temples or back of neck, to be connected to a cybermodem by cables (as described in *Putting the Cyber Into the Punk*, pg.81-82).

You can get by without plugs; all you'll need is a set of **trodes** (pg. 134.). These are self sticking electrodes that pick up neural signals by skin inductance. They're slower and less responsive than plugs (-2 to REF while in the Net), but they are cheaper and don't have any humanity cost.

The other thing you'll need is a **cyberdeck**.

*"My first deck was an ancient Hitachi-Radio Shack. It had this keyboard with a grey-screen monitor, and it was slower than a Congressman passing a tax bill. First thing, I used it to hack into the Zetatech sales office and write myself an order for a brand new Parraline 5750A. That deck had everything; speed, power, memory. I was in love..."*

*"But I still keep that old Hitachi-RS 95 around, just in case. You never know."*

—Spider Murphy

### SGI Technologies "Elysla"

Speed: +3

CPU: 1

Memory: 20

Data Walls: +5

Options: Keyboard, 3x4m videoboard, eight 'trode ports, chip reader, fully portable. 4,260eb.

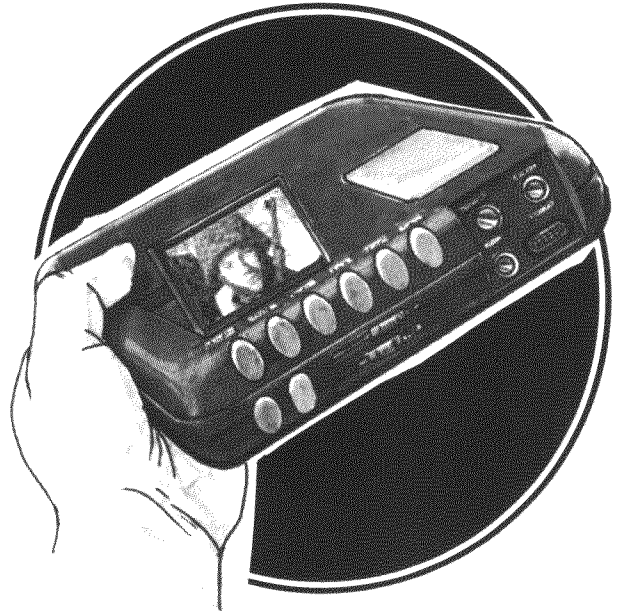
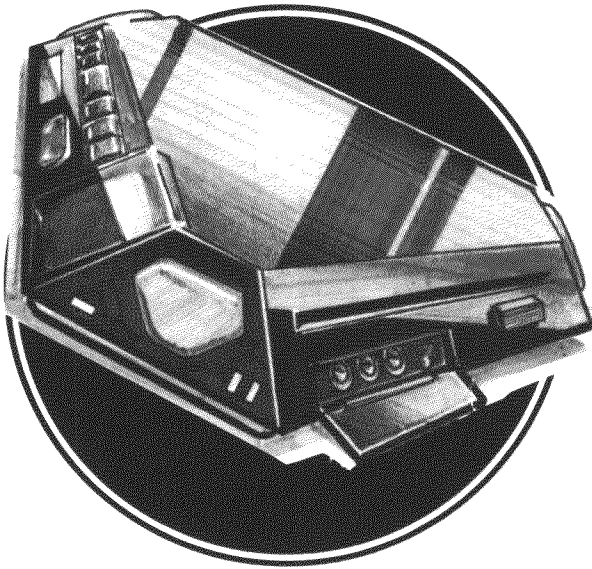

### Zetatech Parraline 5750

Speed: +2

CPU: 1

Memory: 10

Data Walls: +4

Options: Keyboard, 2x3m videoboard, chip reader. About 3,600eb.

### Cyberdecks

The standard cyberdeck is about the size of a paperback book, is made of plastic and weighs about a half-kilogram. It has six plug in ports for adding extra options, as well as six output ports for jacking in other people (the owner of the deck, however, is the only one who can control it, making the other people only passengers).

This is the stock deck everyone starts off their Netrunning career with. Prices range from 500<sup>00</sup> for a used model, up to 1000<sup>00</sup> new. This is where your Referee can show a little mercy, by turning your character on to a cheap used deck.

For a price, of course...

Most cyberdecks are table models—jacked in and blind, a Netrunner isn't going to be going much of anywhere, right? However, technological breakthroughs have taken

the deck off the table and put it on the Street:

**Portable Decks:** These decks have internal, rechargeable power packs good for up to 4 hours (recharge is 1 hour for every hour of battery power). All combat, cyberlimb and cellular decks are of this type. A portable deck costs 2000<sup>00</sup>

**Cyberlimb Decks:** These are portable decks about the size of a pack of cigarettes. They can be installed into a cyberlimb (phone connection cables are jacked between the limb and the phone lines). The deck itself is hardwired right into the body along with the controlling links for the cyberlimb. See *Putting the Cyber into the Punk*, pg. 90-91, for prices.

This can be a very dangerous option—hardwired right in, it's impossible for your

### HITCHHIKERS

But wait! You can jack your experiences into a monitor so that others can watch, or even hook your buddies up with "trodes" to let them ride along. Remember; your Interface Skill is your ability to control and visualize—as in a fantasy run, others can see the mage do magic, they just can't do it themselves. With a trode hook, you can come along—you just can't run software or create stuff.



### CELLULAR DECKS

These are very expensive decks which are implanted or otherwise kept on the body. As long as you stay in one place, you can instantly jack into the Net.

This is a good idea for parties, as it allows your Netrunner to move with the group. A special program in the 'deck runs all the Netrunner's body functions; it keeps him from falling over, drooling, or babbling; he can even use his voice while in the Net to describe things he sees. Because Netrunning actions happen at the speed of thought, this means that your Netrunner seems to go spacey for a few seconds, then says, "Hey," I found the electronic door and I'm running my *Doormaster Mark 5®* utility to open it." Then the door opens.

Unless you get into major Net functions, you need only pop in, run your LOCATE REMOTE utility, take control with your CONTROL REMOTE utility, do your thing and return. It's only when you're cracking systems that you have to stay in the 'face for a long time and bore the rest of the party.

buddies to notice you frying and yank the cables on you. Instead, you just burn.

**Combat Assault Decks:** These decks are constructed of rugged ceramics and steel, capable of taking bullet hits and crash impacts (SP20). Most combat decks are designed to be portable, and have adapter cables which allow them to be plugged into any type of phone line. Around 3000<sup>00</sup> when available (a DIFFICULT Task).

**Cellular Decks:** These are portable decks designed to link up with a cellular phone net. They are very effective anywhere within a city, but are useless in rural areas (most have jacks for manual phone patches). A cellular deck has a 25% chance of losing cellular connection when used in a moving vehicle; a failed roll will automatically drop the Netrunner out of the Net. But it's a small price to pay for the high level of mobility offered by a cellular deck. A cellular deck costs 4000<sup>00</sup>

### Improving Your Deck

A standard deck has only one memory (holds 10 Memory Units (MU), or about ten programs), has a Speed of 0, and a data wall Strength of 2. While this isn't gonna mean much to you now, by the time you get to *Net Combat* (pg. 151) and *Designing Data Fortresses* (pg.154), you're going to want to know how to boost your deck as far as you can go.

**Memory:** For an additional 5,000eb, you can purchase an additional memory for your deck. This improves your program power to 20 MU, double its stock size.

**Speed:** For an additional 2,000eb, you can increase your deck's speed by one level, up to a ceiling of 5. This can be a lifesaver, as deck speed determines who moves first in a Netrunner combat. And in this game, last is dead.

**Data Walls:** For an additional 1,000eb, you can increase your deck's data wall protection by one level, up to a ceiling of 10. Data walls are important; they are the "armor" of the deck, resisting attacks from anti-system programs.

And then there are options...

### Deck Options

In addition to your basic models, any type of deck can be enhanced by adding a few options.

**Trode sets** are self-sticking electrodes that allow you to run the Net without plugs. Trodes are slower than plugs (-2 to REF when in the Net), but have no humanity loss. They are commonly used by novice runners and by "tourists" visiting the Net on a lark.

**Keyboards** are an option which allow a Netrunner to control a deck indirectly. They are abysmally slow (-4 to REF), but are immune to all anti-personnel attacks except *Firestarter*.

**Videoboards** are flat screen, high definition TV monitors which can be used to show a Net's-eye view to outsiders.

**Printers** allow you to make hardcopy images and records from your deck. Most are small laser-printers about the size of a large book, using plain paper.

**Chipreader/recorders** use standard data chips (10eb each) to store programs, images and other useful things from your deck. They are about the size of a pack of cigarettes.

**VoxBoxes** are small speaker units that can synthesize sound from a deck. They can also be used by the Netrunner to talk to outsiders while he's in the Net. About the size of a pack of smokes.

**Scanners** are flat plastic plates with optical character reading and image recording capacity. They range from the size of a sheet of paper, all the way up to a meter on a side.

<b>Option</b>	<b>Cost</b>
Trode set .....	10 <sup>00</sup>
Keyboard .....	100 <sup>00</sup>
Videoboard .....	100 <sup>00</sup> per sq. ft.
Printer .....	300 <sup>00</sup>
Chipreader .....	100 <sup>00</sup>
Extra Chips .....	10 <sup>00</sup> ea
Vox Box .....	300 <sup>00</sup>
Scanner .....	100 <sup>00</sup> -300 <sup>00</sup>

# CYBERPUNK

## CYBERDECK SHEET

Model \_\_\_\_\_ # of CPU \_\_\_\_\_

Cellular     Portable     Combat Deck     Cyberlimb Deck  
 Standard

Total Cost \_\_\_\_\_ DATA WALL STR \_\_\_\_\_

CODE GATE STR \_\_\_\_\_ DECK SPEED \_\_\_\_\_

MEMORY \_\_\_\_\_

### OPTIONS?

Trodes     Keyboard     Videoboard     Printer  
 Chipreader     VoxBox     Scanner     Extra chips \_\_\_\_\_

Your ICON \_\_\_\_\_

### PROGRAMS

Type	MU	STR	Cost
1			
2			
3			
4			
5			
6			
7			
8			
9			
10			
11			
12			
13			
14			
15			
16			
17			
18			
19			
20			
21			
22			
23			
24			
25			
26			
27			
28			
29			
30			
31			
32			
33			
34			
35			

# CYBERPUNK

## CYBERDECK SHEET

Model \_\_\_\_\_ # of CPU \_\_\_\_\_

Cellular     Portable     Combat Deck     Cyberlimb Deck  
 Standard

Total Cost \_\_\_\_\_ DATA WALL STR \_\_\_\_\_

CODE GATE STR \_\_\_\_\_ DECK SPEED \_\_\_\_\_

MEMORY \_\_\_\_\_

### OPTIONS?

Trodes     Keyboard     Videoboard     Printer  
 Chipreader     VoxBox     Scanner     Extra chips \_\_\_\_\_

Your ICON \_\_\_\_\_

### PROGRAMS

Type	MU	STR	Cost
1			
2			
3			
4			
5			
6			
7			
8			
9			
10			
11			
12			
13			
14			
15			
16			
17			
18			
19			
20			
21			
22			
23			
24			
25			
26			
27			
28			
29			
30			
31			
32			
33			
34			
35			

# CYBERFUNK

## CYBERDECK SHEET

**Model** \_\_\_\_\_ **# of CPU** \_\_\_\_\_

Cellular     Portable     Combat Deck     Cyberlimb Deck  
 Standard

**Total Cost** \_\_\_\_\_ **DATA WALL STR** \_\_\_\_\_

**CODE GATE STR** \_\_\_\_\_ **DECK SPEED** \_\_\_\_\_

**MEMORY** \_\_\_\_\_

**OPTIONS?**

Trodes     Keyboard     Videoboard     Printer  
 Chipreader     VoxBox     Scanner     Extra chips \_\_\_\_\_

**Your ICON** \_\_\_\_\_

**PROGRAMS**

Type	MU	STR	Cost
1			
2			
3			
4			
5			
6			
7			
8			
9			
10			
11			
12			
13			
14			
15			
16			
17			
18			
19			
20			
21			
22			
23			
24			
25			
26			
27			
28			
29			
30			
31			
32			
33			
34			
35			

# CYBERFUNK

## CYBERDECK SHEET

**Model** \_\_\_\_\_ **# of CPU** \_\_\_\_\_

Cellular     Portable     Combat Deck     Cyberlimb Deck  
 Standard

**Total Cost** \_\_\_\_\_ **DATA WALL STR** \_\_\_\_\_

**CODE GATE STR** \_\_\_\_\_ **DECK SPEED** \_\_\_\_\_

**MEMORY** \_\_\_\_\_

**OPTIONS?**

Trodes     Keyboard     Videoboard     Printer  
 Chipreader     VoxBox     Scanner     Extra chips \_\_\_\_\_

**Your ICON** \_\_\_\_\_

**PROGRAMS**

Type	MU	STR	Cost
1			
2			
3			
4			
5			
6			
7			
8			
9			
10			
11			
12			
13			
14			
15			
16			
17			
18			
19			
20			
21			
22			
23			
24			
25			
26			
27			
28			
29			
30			
31			
32			
33			
34			
35			

## Programs

Programs are the work horses of Netrunning; they do the fighting, protecting,

**"Okay, it's true I based the icon on my old input. But frack, she really did deserve to be called Soulsucker."**

**—Rache Bartmoss**

decrypting and sneaking for the 'Runner. If a Netrunner is a cybernetic magician, then programs are his spells, there at his mental fingertips.

Programs are rated by Strength, Class, Memory Units used, Cost and ICON:

**Strength** is how powerful the program is, relative to other programs. In combat, the Strength of a program is usually added to the Netrunner's attack roll (much like Weapon Accuracy in a combat situation). The higher the Strength, the better chance the program will be able to do it's job.

**Class** is the type of program; its function. Intrusion programs sneak in, Detection programs detect, Anti-IC programs attack other programs, and Anti-personnel programs attack Netrunners. And so on.

**Memory Units** represent the size of the program. All programs are measured in Memory Units, or MU. Each memory of a cyberdeck or system can hold 10 Memory Units. This means space is at a premium for Netrunners; you can only stack up so much in one run.

**Cost** is the price of the program on the open or black market. Nothing in the future is free. Not even the air, chombatta.

The **ICON** is what the program usually looks like in the Net. But don't count on it; you can alter your program's ICONs to suit your own tastes and style. Just goes to show; don't trust anything.

Enough talk-talk. Read the programs and spend your euro. You got a run to make.

## Program List

### INTRUSION

**Hammer** 400eb

**Class:** Intrusion  
**Strength:** 4 **MU:** 1

Hammer pounds down data walls with a bombardment of raw electrical pulse (use code wall attack formula on pg.142; weaken data wall Strength by 2D6 after every attack). It is very noisy and will automatically alert any defense program within 10 spaces.

**ICON:** A glowing red hammer.

**Jackhammer** 360eb

**Class:** Intrusion  
**Strength:** 2 **MU:** 2

Jackhammer is a quieter, but less powerful (weaken data wall 1D6 STR after attack) version of Hammer. It uses small pulses of energy to wear the data wall away.

**ICON:** A glowing red jackhammer-like object, which fires a stream of white hot energy bolts at the data wall.

**Worm** 660eb

**Class:** Intrusion  
**Strength:** 2 **MU:** 5

Worm is a very subtle program which emulates part of the architecture of the invaded system. It slips behind the data or code wall and opens it from the inside (2 turns, no alert).

**ICON:** A gold-metal, robotic worm, with green neon eyes.

### DECRYPTION

**Codecracker** 380eb

**Class:** Decryption  
**Strength:** 3 **MU:** 2

The Codecracker series, designed by Interfact Software in 2008, is classic code gate crack program. The series disassembles the code gate at the basic program, rather than trying to decipher the key.

**ICON:** A thin beam of white light, which shoots from the Netrunner's hands and spreads through the code gate, turning it to glowing, dissipating fog.

**Wizard's Book** 400eb

**Class:** Decryption (file locks & code gates)  
**Strength:** 4 **MU:** 2

The Wizard's Book is designed to scan through literally billions of possible codes and code words in seconds, trying each one in turn. It is especially effective (STR 6) against code gates.

**ICON:** A stream of blazing white symbols, flowing at incredible speed from the Netrunner's open hands.

**Raffles** 560eb

**Class:** Decryption (file locks & code gates)  
**Strength:** 5 **MU:** 3

Raffles is designed specifically to deal with complex code gates and file locks which have a specific word as the key. It asks the code gate a series of innocuous and leading questions ("Is it bigger than a breadbox?" "Is it hot or cold?"), designed to tell Raffles the nature of the code gate and its key.

**"I've known bit jocks who could crack an EBM system like a cheap safe; in and out before the Icemen could even look up. Sure, they were fast and smart. But mostly, they knew their programs. They knew what to take, and when. So they never got caught off-base when the playing field turned into a battle zone."**

**—Edger**

**ICON:** A dapper young man wearing evening clothes of the early 1900's. He speaks briefly to the door, then vanishes as soon as it opens.

### DETECTION/ALARM

**Watchdog** 610eb

**Class:** Detection/Alarm

**Strength:** 4 **MU:** 5

Watchdog is designed to alert its owners to illegal entries into the system. It can do this by activating an external alarm or by sending a message to an occupied workstation. Netrunners can use Watchdogs to patrol another part of the Net, such as a rival's computer system, then key the Watchdog to run to their cybermodem or workstation if security is breached. This technique allows you to guard your secret files and pathways in other people's computers.

**ICON:** A large, black, metal dog. It has glowing red eyes and a spiked metal collar adorns its neck.

**Bloodhound** 700eb

**Class:** Detection/Alarm

**Strength:** 3 **MU:** 5

Like Watchdog, Bloodhound is designed to detect illegal system entries. However, it also tracks the entry to its source and alerts its masters to the location of intruder. Like Watchdog, Bloodhounds can be set up to watch a part of the Net and report back to you at another workstation or modem.

**ICON:** A large, gun-metal grey hound robot. It has glowing blue eyes and wears a thick cirlet of blue neon as a collar.

**Pit Bull** 780eb

**Class:** Detection/Alarm

**Strength:** 2 **MU:** 6

The most advanced form of the Watchdog series, Pit Bull not only tracks the intruder to its source, but also cuts the line after acquiring the location. It will continue to cut the line every time the intruder logs on from that point of entry, requiring him to move to another phone line or cybermodem. Like Watchdog, Pit Bull can be set up to watch a part of the Net and report back to you at another workstation or modem.

**ICON:** A short, heavily built, steel dog robot. It has glowing red eyes and wears a thick cirlet of red neon as a collar.

**SeeYa** 280eb

**Class:** Detection/Alarm

**Strength:** 3 **MU:** 1

SeeYa is designed to detect invisible ICONS within the range of one Subgrid. This includes programs, hidden Netrunners and things hidden by Invisibility in a virtual reality.

**ICON:** A shimmering silver screen.

**Hidden Virtue** 280eb

**Class:** Detection/Alarm

**Strength:** 3 **MU:** 1

Hidden virtue is a Rache Bartmoss design used to

tell "real" ICONs from other objects in a virtual reality. For example, HV could tell the difference between a real person and a virtual one or which book in a virtual library is really a data file.

**ICON:** A glowing green ring which the Netrunner looks through.

**Speedtrap** 600eb

**Class:** Detection/Alarm

**Strength:** 4 **MU:** 4

Speedtrap is an early warning program that detects the presence of an offensive program within 10 squares of the Netrunner's position (within the same subgrid). It cannot tell you where the program is, only that it exists.

**ICON:** A flat, glowing plate of glass, in which images appear. If a program is present, the plate fills with the image of a robotic monster. If there is no program present, the plate remains blank.

### ANTI SYSTEM

**Flatline** 570eb

**Class:** Anti System

**Strength:** 3 **MU:** 2

Flatline is designed to trace and kill the operating interface of your cybermodem—one zap, and your deck must have its interface chip replaced. A Flatline can be carried by an intruding Netrunner and used to attack the decks of other 'Runners encountered in the Net.

**ICON:** A beam of yellow neon which shoots from the Netrunner's fingertips.

**Poison Flatline** 540eb

**Class:** Anti System

**Strength:** 2 **MU:** 2

Poison Flatline is designed to destroy not only the interface software, but the Memory of the 'deck as well. This wrecks the cybermodem, requiring total replacement. Like Flatline, Poison Flatline can be carried by an intruding Netrunner and used to attack other 'Runners encountered in the Net.

**ICON:** A beam of green neon which launches from the Netrunner's fingertips.

**Krash** 570eb

**Class:** Anti System

**Strength:** 3 **MU:** 2

Krash causes the CPU of an attacked deck or system (closest CPU in multi-processor systems) to become inoperative for 1D6+1 turns. A Krashed deck automatically drops its 'runner out of the Net, while a Krashed system may not act until the time period has elapsed and it has re-booted itself.

**ICON:** A large, cartoon anarchist bomb, with a sizzling fuse.

**DecKRASH** 600eb

**Class:** Anti System

**Strength:** 4 **MU:** 2

A modified version of Krash, which operates only on cyberdecks, causing the Netrunner to be dropped out of the Net for 1D6 turns.

**ICON:** A cartoon stick of dynamite with fuse.

**Murphy** 600eb

**Class:** Anti System

**Strength:** 3 **MU:** 2

Murphy causes the affected deck or system to randomly launch all of its applications, using as many actions as it has available to do this.

**ICON:** You never know...

**Virizz** 600eb

**Class:** Anti System

**Strength:** 4 **MU:** 2

This virus attack automatically ties up one action of the system or deck until the deck is turned off.

**ICON:** A glittering DNA shape made of lights and neon.

**Viral 15** 590eb

**Class:** Anti System

**Strength:** 4 **MU:** 2

This virus causes the affected system or deck to randomly erase one file or program each turn until the deck is turned off.

**ICON:** A swirling metallic blue fog with a white neon DNA helix imbedded in the center.

### EVASION/STEALTH

**Invisibility** 300eb

**Class:** Evasion/Stealth

**Strength:** 3 **MU:** 1

Invisibility overlays a false signal on your cybermodem trace, making it appear to be harmless static. When activated, Invisibility will allow the Netrunner to pass unnoticed through the Net.

**ICON:** A flickering, iridescent sheet, which drapes over the Netrunner.

**Stealth** 480eb

**Class:** Evasion/Stealth

**Strength:** 4 **MU:** 3

Stealth mutes the Netrunner's cybersignal, making him harder to detect. He is still visible, but offensive programs will not react to his presence. However, other Netrunners can still see him.

**ICON:** a sheet of black energy draped over the Netrunner's ICON.

**Replicator** 320eb

**Class:** Evasion/Stealth

**Strength:** 3 for most programs, 4 vs. Pit Bulls, Bloodhounds and Hellhounds

Replicator creates millions of copies of your cybermodem trace, sending them off in all directions to confuse a pursuing program. If successful, the pursuer will track the wrong signal to a dead end. Replicator is especially good against the "Dog" series of programs, as it overloads their limited AI programming structure with too many decisions.



**ICON:** A chrome sphere creating millions of holographic images of the Netrunner, flickering away in all directions.

## PROTECTION

**Shield** 150eb

**Class:** Protection  
**Strength:** 3 **MU:** 1

Shield stops direct attack to the Netrunner. On a successful use of Shield, the attack is thwarted and no damage is taken.

**ICON:** A shifting circular energy field appearing in front of the Netrunner.

**Force Shield** 160eb

**Class:** Protection  
**Strength:** 4 **MU:** 2

A more powerful version of Shield.

**ICON:** A flickering silver energy barrier.

**Reflector** 160eb

**Class:** Protection  
**Strength:** 5 **MU:** 2

Reflector is designed to repel all Stun, Hellbolt and Knockout attacks. It is unable to stop any other types of anti-personnel attacks.

**ICON:** A flare of blue green light, coalescing into a mirrored bowl.

**Armor** 170eb

**Class:** Protection  
**Strength:** 4 **MU:** 2

This program is designed to slow and retard all anti-personnel attacks. On a successful use of Armor, the attack is stopped. On an unsuccessful use, Armor will reduce all Stun, Hellbolt, Brainwipe, Zombie and Hellhound attack damages by 3 points.

**ICON:** Glowing golden armor in a high tech design.

**Flak** 180eb

**Class:** Protection **MU:** 2  
**Strength:** 4 for most programs, 2 vs. Pit Bulls, Bloodhounds and Hellhounds

Flak creates a tremendous wall of static, blinding the attacking program and allowing the Netrunner to easily evade. Flak is very good against most programs, but it is relatively ineffective against the "Dog" series.

**ICON:** A cloud of blinding, glowing, multicolored lights, swirling in all directions.

## ANTI-IC

**Killer II, IV & VI** 1320eb, 1400eb, 1480eb

**Class:** Anti-IC **MU:** 5  
**Strength:** 1 for each level of program

Killer is a general purpose virus program designed to kill other programs. It enters the logic structure of its victim and inserts errors with blinding speed, causing the target to crash (1D6 to STR). Killer is a very simple program; smooth,

elegant and tough. There are many versions of Killer.

**ICON:** A large manlike robot, dressed as a metallic samurai. His eyes glow red from behind his mask, and he carries a glowing katana.

**Manticore** 880eb

**Class:** Anti-IC  
**Strength:** 2 **MU:** 3

Manticore is the simplest of a series of Assassin programs; a type of Killer designed to locate and destroy Demon programs. If no Demon is present in your cybermodem file, Manticore will ignore you.

**ICON:** A huge, lionlike shape, drawn in red neon schematic lines. A large scorpion tail arcs over one shoulder.

**Hydra** 920eb

**Class:** Anti-IC  
**Strength:** 3 **MU:** 3

A more powerful variant of Manticore.

**ICON:** A glittering blue fog that encircles its target and dematerializes it.

**Dragon** 960eb

**Class:** Anti-IC  
**Strength:** 4 **MU:** 3

The most powerful variant of Manticore.

**ICON:** A great golden scaled dragon robot. Laser beams shoot in multicolored arcs from its eyes, and it is wreathed in electrical discharges.

**Aardvark** 1000eb

**Class:** Anti-IC **MU:** 3

**Strength:** 4 vs. Worms, no effect on any other programs.

Aardvark is designed to locate and destroy intruding Worm programs. It will immediately seek out and destroy any Worm program carried, even if it is loaded as a Demon subroutine. **ICON:** A matrix of thin yellow neon lines, which surround the Worm program and close around it like a tightening net. The matrix then dematerializes with the Worm entrapped.

## ANTI-PERSONNEL

**Stun** 6000eb

**Class:** Anti-Personnel  
**Strength:** 3 **MU:** 3

Stun sends an overpowering bolt of energy into the target, causing him to be frozen in place for 1D6 turns. This is a very commonly used offensive program, particularly by the NetCops.

**ICON:** A bolt of blue flame streaking from the Netrunner's open palm.

**Hellbolt** 6750eb

**Class:** Anti-Personnel  
**Strength:** 4 **MU:** 4

A more powerful version of Stun, Hellbolt causes physical damage (1D10 per attack) to the Netrunner. Damage is subtracted from the Netrunner as a wound until he is dead. Saves vs. Stun and Death must also be made.

**ICON:** A bolt of crimson fire launched from the Netrunner's raised hand.

**Sword** 6250eb

**Class:** Anti-Personnel  
**Strength:** 3 **MU:** 4

A variant of Hellbolt, Sword causes 1D6 in physical damage per hit.

**ICON:** A glowing energy katana.

**Brainwipe** 6500eb

**Class:** Anti-Personnel  
**Strength:** 3 **MU:** 4

Brainwipe is the simplest of a series of black programs, all of which are designed to attack the Netrunner instead of his programs. All black programs can be carried by an intruding Netrunner and used to attack other 'Runners encountered in the Net. Brainwipe tracks the victim down, fries his forebrain with a jolt of current, and reduces him to a drooling vegetable, (1D6 each turn to INT). The screaming Netrunner feels his mind melt away, until his INT is reduced to 0 and he dies. Lost INT cannot be regained.

**ICON:** An acid-green electrical arc, which leaps from the floor and engulfs and kills the 'runner.

**Zombie** 7500eb

**Class:** Anti-Personnel  
**Strength:** 5 **MU:** 4

An advanced and more powerful version of Brainwipe, Zombie wipes out the victim's forebrain, making him into a drooling vegetable (1D6 to INT each turn).

**ICON:** A shrouded, skeletal form, enveloped in a stinking grey mist. Its eyes are sunken and its flesh is a mass of rotting, maggot-filled meat. It lunges out and rips the Netrunner's head off.

**Liche** 7250eb

**Class:** Anti-Personnel  
**Strength:** 4 **MU:** 4

An advanced form of Zombie, Liche also rips away the forebrain (1D6 to INT), but selectively. Most memory is eradicated, leaving enough to implant an easily controlled (by the Referee) pseudo personality into the empty brain.

**ICON:** A metallic skeleton dressed in black robes and wearing a blackened crown. It grabs the Netrunner in its freezing grasp and drags him back under the floor.

**Firestarter** 6250eb

**Class:** Anti-Personnel  
**Strength:** 4 **MU:** 4

Firestarter is indirectly anti-personnel in nature. Using its Bloodhound subroutines, it tracks the intruder to its source. Silently entering the electrical system, it blasts the wiring with a megawatt power surge. The jolt causes wiring fires, explosions, and fries the Netrunner as if he were in an electric chair. Firestarter programs are excellent covert killers, as they leave little or no evidence in the charred wreckage.

**ICON:** A blazing pillar of fire, which speaks the Netrunner's name in a hissing, booming voice, then leaps at him.

**Hellhound** 10,000eb

**Class:** Anti-Personnel

**Strength:** 6 **MU:** 6

Hellhound combines the worst aspects of Pit Bull and Flatline. It locates the intruder and sends out a modulated pulse designed to cause a heart attack in humans (2D10 wound damage). If the Netrunner escapes in time, it remains active within the Net, lurking silently in major long distance terminals, waiting for the specific brain wave pattern of the intruder to show up. It then tracks him down again and kills him. Patient and remorseless, Hellhound can wait years for its victim to log on. Its rarity and high price tag prohibits its use against all but extremely high level Netrunners.

**ICON:** A huge, black, metal wolf. It's eyes glow white, and fire runs in ripples all over its body. It speaks in a grating, metallic voice, repeating the Netrunner's name.

**Spazz** 6250eb

**Class:** Anti-Personnel

**Strength:** 4 **MU:** 3

Spazz causes epileptic seizures in the Netrunner's nervous system. REF is automatically reduced to half for 1D6 turns, slowing the Netrunner's Initiative rolls drastically.

**Appearance:** A nimbus of electrical energy surrounding the target.

**Glue** 6500eb

**Class:** Anti-Personnel

**Strength:** 5 **MU:** 4

Used by the "Icemen" of NetWatch as an arrest program, Glue freezes the Netrunner in place for 1D10 turns (4 turns is long enough to get a good trace on his location in Realspace). The Netcops can then send a squad along to pick him up at their leisure.

**ICON:** A shifting pattern of red shapes flickering across the floor to entangle the Netrunner.

**Knockout** 6250eb

**Class:** Anti-Personnel

**Strength:** 4 **MU:** 3

Knockout delivers a powerful modulated shock that knocks the Netrunner out for 1D6 hours. He is automatically dumped out of the Net, and is in a coma in Realspace for this period of time. Knockout is a very common defense against low level intrusion (like the Phone Co. or an office system).

**ICON:** A yellow neon schematic boxer appears and strikes out at the Netrunner's ICON.

**Jack Attack** 6000eb

**Class:** Anti-Personnel

**Strength:** 3 **MU:** 3

Jack attack is often used as an arrest program. It stops the Netrunner from jacking out for 1D6 turns if it is successfully run.

**ICON:** A pair of glowing schematic handcuffs encircling the Netrunner's wrists.

## CONTROLLERS

**Note:** Controllers are run using the CONTROL REMOTE function of the Menu, and have no ICONS.

**Viddy Master** 140eb

**Class:** Controller

**Strength:** 4 **MU:** 1

Allows control of videoboard.

**Soundmachine** 140eb

**Class:** Controller

**Strength:** 4 **MU:** 1

Allows control of microphones, loudspeakers, vocoders (computer voice boxes).

**Open Sesamé** 130eb

**Class:** Controller

**Strength:** 3 **MU:** 1

A low level program for opening doors, elevators, etc.

**Genie** 150eb

**Class:** Controller

**Strength:** 5 **MU:** 1

A high level program for opening doors, elevators, etc.

**Hotwire™** 130eb

**Class:** Controller

**Strength:** 3 **MU:** 1

Allows remote control of robotic cars, vehicles, etc.

**Dee-2®** 130eb

**Class:** Controller

**Strength:** 3 **MU:** 1

Allows control of robots, cleaning mecha, autofactories, etc.

**Crystal Ball** 140eb

**Class:** Controller

**Strength:** 4 **MU:** 1

Allows control of video cameras, remote sensors, etc.

**News At 8™** 140eb

**Class:** Controller

**Strength:** 4 **MU:** 1

Allows through-the-Net access to Data Terms and Screamsheet boxes for information.

**Phone Home** 150eb

**Class:** Controller

**Strength:** 5 **MU:** 1

Allows the Netrunner to place or receive calls in the Net. Phone Home is also Strength 2 to intercept and listen into other calls.

## UTILITIES

**Databaser** 180eb

**Class:** Utility

**Strength:** 8 **MU:** 2

Creates open files to store information in.

**Alias** 160eb

**Class:** Utility

**Strength:** 6 **MU:** 2

Changes file names, replacing the filename with an innocuous title that hides its true nature.

**Re-Rezz** 130eb

**Class:** Utility

**Strength:** 3 **MU:** 1

Recompiles and restores damaged files or programs. If a program is de-rezzed, this is the best way to get it back short of having a copy.

**Instant Replay** 180eb

**Class:** Utility

**Strength:** 8 **MU:** 2

Makes a record of the Netrunner's trip, so that he can retrace his steps through the Net.

**GateMaster** 150eb

**Class:** Utility

**Strength:** 5 **MU:** 1

Deletes and kills Virizz and Viral 1.5 programs without requiring a total shutdown of the system or deck.

**Padlock** 160eb

**Class:** Utility

**Strength:** 4 **MU:** 2

Keeps anyone other than the Netrunner from logging onto the deck unless the proper code word is used.

**ElectroLock** 170eb

**Class:** Utility

**Strength:** 7 **MU:** 2

Changes an open file to a LOCKED file equal to a Code Gate of Strength 3.

**Filelocker®** 140eb

**Class:** Utility

**Strength:** 4 **MU:** 1

Locks an open file to a level equal to a Code Gate of Strength 5.

**NetMap** 150eb

**Class:** Utility

**Strength:** 4 **MU:** 1

Provides a locator map of most major Net regions, adding +2 to any System Knowledge check to find a place in the Net.

**File Packer** 140eb

**Class:** Utility

**Strength:** 4 **MU:** 1

Compacts files to half their normal MU size. Takes 2 turns to unpack a file to normal size.

**Backup™** 140eb

**Class:** Utility

**Strength:** 4 **MU:** 1

Backup allows you to make a copy of any program (except for Anti-IC and Anti-personnel types). You will need extra data chips and a cyberdeck chipreader for this.

## Demon Series Programs

These are four levels of programs created by the legendary Rache Bartmoss of CCI Development in 2004. The Demon Program is a generic program with the ability to incorporate several other programs as subroutines—in short, two, three, four or even five programs in one. To use the program, you must activate the Demon, then specify the chosen subroutine it carries. The subroutine programs look and act just as their originals, but are usually less powerful, as they must use the program strength of the Demon core in combat.

**Imp** 1000eb

**Class:** Demon (carries 2 programs)

**Strength:** 3 **MU:** 3

**ICON:** A small, orange sphere of light, with two amused looking red eyes. It continually emits a series of beeps, whistles and pinging noises.

**Afreet** 1160eb

**Class:** Demon Series (carries 3 programs)

**Strength:** 3 **MU:** 4

**ICON:** A tall, powerfully built black man, dressed in elegant evening clothes and wearing a fez. He carries a dagger in his jacket, and speaks in a formal, deep voice.

**Succubus** 1200eb

**Class:** Demon (carries 4 programs)

**Strength:** 4 **MU:** 4

**ICON:** A voluptuous, nude female form, hairless, and made from shiny chrome metal. She has large, batlike wings, and blue, pupilless eyes.

**Balron** 1240eb

**Class:** Demon (carries 4 programs)

**Strength:** 5 **MU:** 5

**ICON:** A huge, male figure, powerfully built. He is dressed in futuristic black armor, glittering with reflected highlights. In one hand, he carries a red-glowing energy blade; his other arm ends in a series of neon-green, glowing tentacles. His eyes glow red behind his visor, and his voice is a sibilant hiss.

## Copying Your Programs

A smart idea. You can copy almost any program in your arsenal. All you need is the *Backup* utility, a data chip, and a chipreader to put it in. A single chip holds 1 MU, but *Backup* is designed to break a larger file up over two or more chips.

Chips cost 10.00. To copy the contents of the average deck will cost between 100 to 300 eb. Cheap at twice the price.

**Note:** Anti-IC and Anti-Personnel programs cannot be *Backup*-copied; they have special copy-protection routines that erase the chip in the copy process. This makes

sure you come back to your friendly local Fixer for a new copy of *Hellhound* when yours crashes. You can make a copy using your Programming Skill against a Task Difficulty of 28. But think what happens if you screw up...

## Changing Programs

Chips are inserted into your deck before the start of the run. Once you're in the face, you're committed. However, if you're willing to dump out of the Net and abort the run, you can change chips (1 turn). You'll have to jack back in and retrace your steps, but this time when you meet that *Brainwipe*, you'll be *ready*.

## Designing New Programs

Check out the *Designing Your Own Programs Section*, pg. 158 for details.

## Live Link Up

Okay, you've got a deck and some programs. What else are you gonna need?

The last thing you're going to need is a place to plug in. This means a **phone number**.

If you're running a stationary cyberdeck, this is as simple as contacting your local office of **Internet Phone Corporation** and arranging for a phone number. The office checks your background and credit record, then issues you a Net Access code (equivalent to a 20th century phone number).

If you have a cellular phone or cellular cybermodem, the process is equally simple; call up Internet, tell them your cyberdeck's serial number, get a credit check and your Net Access code is issued to you right then and there

The Net Access code is billed a flat rate (30eb per month), plus additional costs for long distance Netruns (or calls). The bill is sent to your home on the 1st of the month. If you don't have a permanent residence, Internet will arrange to have the funds deleted out of your credit account automatically, sending a statement to wherever you get your mail.

## "HMMM..." YOU THOUGHT

By now, some of you more creative types are thinking, "Hey, why not just crash into Internet's mainframe and delete my bill each month?" And we'd be disappointed if you didn't think of it—it means you're thinking like true *Cyberpunks* and that makes us proud.

But let's put it this way. You know how tough Arasaka's Tokyo Main is? Well, Arasaka still pays it's monthly bill to Internet.

These guys don't use the Net. They *own* the Net. You don't even want to guess what Internet can throw at you. It even scares Saburo Arasaka.

**Note:** We're not saying you *can't* jack your phone bill around (frack, it's a time honored skill of the Loyal Order of Blue Boxers & Phone Phreeks). But Referees with a consistent phone-phreeking problem should feel free to unleash the Hounds of Hell on their habitual offenders. Running from the world's largest corporation makes for a heck of an adventure.

## PROGRAM LIST

Name	Class	Function	Strength	MU	Cost
<b>INTRUSION</b>					
Hammer	Intrusion	Knocks down data walls (2D6 per attack to data wall Strength)	4	1	400
Jackhammer	Intrusion	Knocks down data walls (1D6 per attack to data wall Strength)	2	2	360
Worm	Intrusion	Infiltrates and breaks down data walls silently in 2 turns	2	5	660
<b>DECRYPTION</b>					
Code Cracker	Decryptor	Breaks down code gates and file locks	3	2	380
Wizard's Book	Decryptor	Deciphers code gates (STR 6) & file locks	4/6	2	400
Raffles	Decryptor	Deciphers code gates & file locks	5	3	560
<b>DETECTION/ALARM</b>					
Watchdog	Detect/Alarm	Detects entry and alerts owner	4	5	610
Bloodhound	Detect/Alarm	Detects entry and traces signal, then alerts master	3	5	700
Pit Bull	Detect/Alarm	Detects entry, traces signal and cuts intruder's line until killed	2	6	780
SeeYa	Detect/Alarm	Detects "Invisible" ICONS	3	1	280
Hidden Virtue	Detect/Alarm	Detects "real" things in virtual realities	3	1	280
Speedtrap	Detect/Alarm	Detects hidden programming within 10 spaces	4	4	600
<b>ANTI SYSTEM</b>					
Flatline	Anti System	Kills operating CPU	3	2	570
Poison Flatline	Anti System	Kills all system Memory	2	2	540
Krash	Anti System	Crashes system CPU for 1D6+1 turns	3	2	570
DeckKrash	Anti System	Crashes deck CPU for 1D6 turns. Drops opponent out of Netspace	4	2	600
Virizz	Anti System	Ties up 1 action of system till deck is turned off	4	2	600
VIRAL 15	Anti System	Erases one file randomly each turn	4	2	590
Murphy	Anti System	Causes system to randomly launch programs	3	2	600
<b>EVASION/STEALTH</b>					
Invisibility	Evasion	Hides cybersignal, making you appear "invisible"	3	1	300
Stealth	Evasion	Mutes cybersignal, making it harder to detect	4	3	480
Replicator	Evasion	Confuses attacking IC by creating millions of deck signals	3/4	2	320
<b>PROTECTION</b>					
Shield	Protection	Stops attacks to Netrunner	3	1	150
Force Shield	Protection	Stops stronger attacks to Netrunner	4	2	160
Reflector	Protection	Reflects and stops <i>Stun</i> , <i>Hellbolt</i> , <i>Knockout</i> attacks	5	2	160
Armor	Protection	Reduce <i>Stun</i> , <i>Hellbolt</i> , <i>Brainwipe</i> , <i>Zombie</i> , <i>Hellhound</i> attacks by -3 pts.	4	2	170
Flack	Protection	Creates static walls to blind attackers. STR 2 vs DOG series programs	4/2	2	180
<b>ANTI-IC</b>					
Killer II	Anti IC	Attacks all types, 1D6 damage to target STR. Mobile	2	5	1320
Killer IV	Anti IC	Attacks all types, 1D6 damage to target STR. Mobile	4	5	1400
Killer VI	Anti IC	Attacks all types, 1D6 damage to target STR. Mobile	6	5	1480
Manticore	Anti IC	Attacks <i>Demons</i> , de-rezzing instantly	2	3	880
Hydra	Anti IC	Attacks <i>Demons</i> , de-rezzing instantly	3	3	920
Dragon	Anti IC	Attacks <i>Demons</i> , de-rezzing instantly	4	3	960
Aardvark	Anti IC	Detects and attacks <i>Worms</i> , de-rezzing instantly	4	3	1000
<b>ANTI-PERSONNEL</b>					
Stun	Anti-Person.	Freezes Netrunner for 1D6 turns	3	3	6000
Hellbolt	Anti-Person.	Cause 1D10 physical damage to Netrunner	4	4	6750
Sword	Anti-Person.	<i>Hellbolt</i> variant, causes 1D6 physical damage to Netrunner	3	4	6250
Brainwipe	Anti-Person.	Reduce INT by 1D6 each turn, killing Netrunner	3	4	6500
Zombie	Anti-Person.	Reduce INT by 1D6 each turn, leaving Netrunner mindless	5	4	7500
Liche	Anti-Person.	Erases memory, replacing with pseudo-personality	4	4	7250
Firestarter	Anti-Person.	Causes power surge, starting fire in Netrunner's deck.	4	4	6250
Hellhound	Anti-Person.	Tracks Netrunner, waits, then causes 2D10 damage/turn	6	6	10,000
Spazz	Anti-Person.	Reduces Netrunner REF. for 1D6 turns	4	3	6250
Glue	Anti-Person.	Locks Netrunner in place for 1D10 turns	5	4	6500
Knockout	Anti-Person.	Causes coma for 1D6 hours	4	3	6250
JackAttack	Anti-Person.	Prevents Netrunner from logging off	3	3	6000
<b>CONTROLLERS</b>					
Viddy Master	Controller	Video board controller	4	1	140
Soundmachine	Controller	Microphone/voxbox controller	4	1	140

Open Sesamé	Controller	Electronic door controller	3	1	130
Genie	Controller	More powerful door, elevator controller	5	1	150
Hotwire™	Controller	Vehicle controller	3	1	130
Dee-2®	Controller	Robot controller	3	1	130
Crystal Ball	Controller	Video/camera controller	4	1	140
News At 8	Controller	Screamsheet box controller	4	1	140
Phone Home	Controller	Send & receive cellular calls, intercepts calls at STR. 2	5	1	150

### UTILITIES

Databaser	Utility	Stores up to 10,000 pages per file of information/text	8	2	180
Alias	Utility	Replaces file name with false one	6	2	160
ReRezz	Utility	Recompiles and restores destroyed programs	3	1	130
Instant Replay	Utility	Records coordinates of current Netrun for replay later	8	2	180
Gatmaster	Utility	Detects and destroys <i>Virizz</i> , <i>Viral 15</i> programs	5	1	150
PadLock	Utility	Refuses to allow log on through deck unless code is given	4	2	160
Electrolock	Utility	Locks files as is a STR. 3 code gate.	7	2	170
FileLocker®	Utility	Locks files, requiring code word (runner's choice) to open	4	1	140
NetMap	Utility	Provides accurate maps of most well-known Net locations	4	1	150
Packer	Utility	Reduces programs by 1/2 size. Take 2 turns to unpack	4	1	140
Backup	Utility	Creates copies of most programs on chip	4	1	140

### DEMON SERIES

Imp II	Demon	Carries 2 programs	3	3	1000
Afreet II	Demon	Carries 3 programs	3	4	1160
Succubus II	Demon	Carries 4 programs	4	4	1200
Balron II	Demon	Carries 4 programs	5	5	1240

Didn't pay your bill this month? Internet gives you thirty days to pay up, with polite reminders at the end of the thirty. Past sixty days, Internet automatically deletes your Net Access code. From then on, the code is invalid and you just don't make calls. Period. For a 1,000eb deposit, you can get a new Net Access Code.

Maybe.

Past 120 days, Internet scrambles a Solo team and starts looking for you. Collections in the 21st Century is a rapidly expanding field, with exciting new developments in man portable weapons, brainwipe and behavior adjustment through selective use of adversive pain therapy.

Just so you know.

You don't *have* to have a Net Access code. You can jack a deck into someone else's line (making yourself really popular with your cube mate), or even jack into a street

Data Term. However, at 1eb per minute plus long distance charges, this can be an expensive proposition. You also have to put the euro right up front to log on.

This may be one reason why a favorite tactic of Netrunners is to sneak into a big corporate office building where they can log on using the corporation's phones to make their runs. This is illegal and dangerous (corporate guards aren't known for a sense of humor), but it is free. And that's a powerful incentive for some people.

Got a Net Access code? Let's get busy.

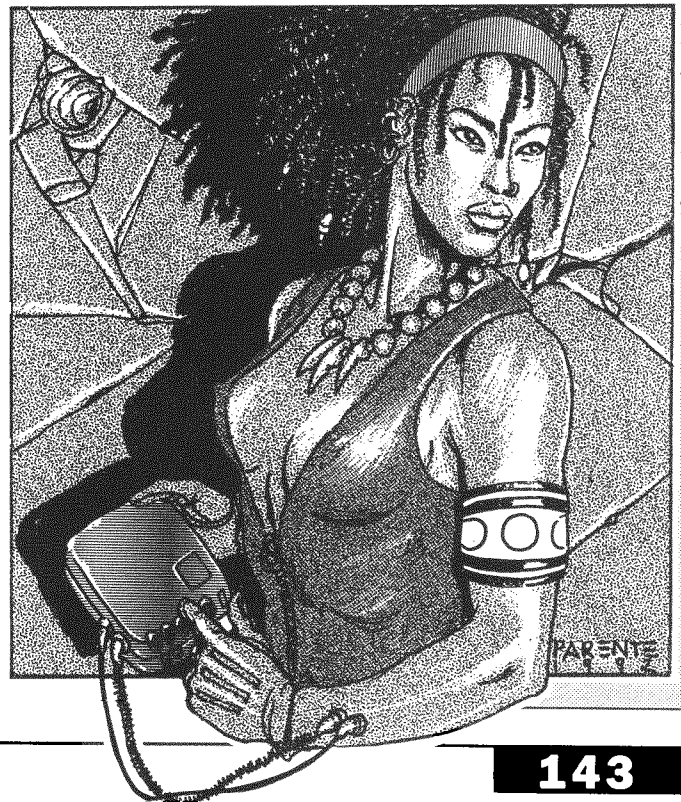



## Running the Net

Okay, let's start with the basics.

First, you gotta know how to move around. That's easy. Each turn in the Net, you can move five spaces, no matter how big those spaces are. On the **Net World Map** (pg. 146), a single space is a thousand square miles. On a **City Grid Map**, a single space is about a dozen blocks. On a **Subgrid Map** (one square of a City Grid Map), a single space is roughly a few yards. No matter where you are, you still move five spaces per turn.

Howzat?? Look, chombatta, in reality, you're not moving at all— it's just your point of view that's moving. Think of it like you're sending out an eyeball on a long string. The eyeball travels, but you don't.

In the Net, things move fast. Speeds are measured in nanoseconds, not even seconds. We meat minds are turtles compared to the big systems and the AIs. To get things down to a scale we humans can comprehend, the Interface program in your deck scales time down to match your perceptions. In real time, you may have just moved two thousand miles in one second. But you just perceive it as "teleportation"— zap; you're there. When distances are smaller, the Interface program slows things down so that you don't crash through the sides of some honcho's data fortress.

Five spaces per one second turn. It's the Law.

Second rule. All travel in the Net is done in straight lines. This means you go through the sides of a space, not the corners (see illustration). Sure, real people cut the corners all the time. But remember, you aren't really moving at all. The space you're not moving through doesn't really "exist", and even if it did, the perception of volume is a creation of the old I-G Transformations. So you play by the Interface's rules in the Net. Got it?

Okay, so now we're moving.

On the Net World Map (pg. 146), we move by going from one Long Distance Link (LDL) to the next. Say you want to go from Night City to London. You can't just teleport to London. No, you'll have to go through a series of short 5 square hops to get where you want to go.

You do this by locating the furthest Long Distance Link (LDL) within your five space range. From Night City, this means your options would be Salt Lake, Denver, Atlanta, Chicago, New York/BosWash, New Orleans and Havana. You couldn't jump the whole way; at five spaces per turn, you'd end up stranded in the ocean without an LDL to stop at.

So you jump from Night City to New York. From there, you can easily jump to London; it's five spaces exactly. But wait a sec... There's one more thing you need to consider. **Security Levels**.

### Security Levels

If you're going to be making a legal long distance jump, going to New York is no problem. But face it; you don't want to spend a lot of euro on long distance charges. You want to run that old LONG DISTANCE LINK command on the Menu and blast on through.

That's where Security Levels come in. Each LDL is ringed with codes and defenses to keep you from logging free calls on Internet's phone tab. These defenses are reflected in the LDL's Security Code; a value you must roll a 1D10 value equal or higher than in order to scam the system. If you fail the roll, you've been caught. Worse, your actions may alert the ever-vigilant NETWATCH goons, who will track you down and drag you off to Death Valley Maximum Security Prison. Roll 1D6 and see what happened:

- 1-4 You are cut off the line & are charged for the call (see Sidebar, pg. 142).
- 5 You are cut off and NETWATCH is given your access code. Expect a friendly visit in Realspace soon.
- 6 The NetCops try to bust you on the spot (Roll 1D6)
  - 1-2 They fine you 1D6x100eb.

### LONG DISTANCE CHARGES

Count the number of spaces between your starting point and your ending point. Multiply this by .20 eb per turn spent in the Net to determine how much you're charged. *Example: Our run from Night City to London covers eight spaces and takes two turns. The cost of the call will be 3.20eb.*

**Terminology Note:** Net Turn and Net Round are used interchangeably throughout this chapter.

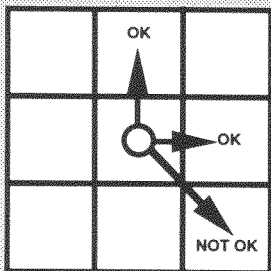

### MOVEMENT IN THE NET

3-5 You escape. They don't have a trace on you, but will spend 1D6+1 days patrolling that area of the Net hoping you'll show up.

6 You escape, but they issue an ANB (All Net Bulletin) on you. They know you're out there, and they're looking for you. It's only a matter of time...

Often, it's smarter to take the long way around when approaching a target city, moving through low security LDLs instead of jamming right through the high security ones.

### Tracing

There's another reason to pick your LDLs carefully. Besides having a Security Level, each LDL also has a **Trace Value**. The trace value represents the difficulty of tracking your cybersignal through that particular LDL. Each LDL you pass through has its own Trace Value; the total value of all LDLs passed through in a Net run represents the Difficulty of tracing your signal back to its source. By picking the right LDLs, or by going through a *lot* of them, you can make it nearly impossible to trace your point of origin.

This is important, particularly if you are being attacked by a program with some type of tracing function built into it. For example, if a *Hellhound* fails to nail you before you jack out, it must attempt to trace your signal in order to execute its backup program (find out where the Netrunner entered the Net and wait till he reenters— then kill him).

To trace you, the program must roll a 1D10 + Strength value equal to or greater than the total of all the Trace Values you have passed through on your trip. If the program fails this roll, it will not be able to get a trace on your signal.

### City Grids

Once you hit your target city, it's time to move to the **City Grid** map. This is an overall map of the city; much like a Realspace map, the City Grid Map shows the

locations of important places in the city—in this case, important systems and Data Fortresses. You enter the City Grid map through the LDL ICON on the map, then move at five spaces per turn to where your target system is located.

We've given you a sample City Grid based on Night City. As a Referee, you'll want to construct your own City Grids; there's a blank map for this purpose as well. If you have a really large city, you may want to use several City Maps placed end to end.

Each Data Fortress on the City Grid has an identifying ICON on the City Grid Map. These ICONS are coded by the level of security the system is known to have.

**Grey Systems:** These systems utilize only Alarm and Detection programs. They include most City governments, Universities and small private businesses.

**Level 1:** These systems include small corporations, police services and large private businesses. Anti-IC programs are used in these systems, as well as Detection and Alarm programs.

**Level 2:** Anti-IC and anti system programs are used here. These systems include medium sized corporations and very large private businesses.

**Level 3:** These systems use non-fatal anti-personnel programs. Level three systems are usually operated by large corporations, state governments and other moderately powerful groups. These people don't want you in their systems, but they don't have the clout to waste you out of hand. They'll just hurt you and hand you over to NETWATCH.

**Black Systems:** These fortresses use fatal and non-fatal anti-personnel software. Black systems include multinational corporations and government agencies like the CIA. They know you have no business being in their system, and they don't care what your lawyers think about them. They're willing to bury both you and the ACLU in the landfill, and have the clout to do it.



### HANGING OUT

If the system you want to visit is off line or shut down, there's going to be a blank space in the Net instead of a Data Fortress ICON. You may have to wait around a while before your target shows up. For example, if First Eurobank has 9-5 hours, this means you may have to wait until the bank comes on line.

So there you are, hanging out. Sooner or later, you're going to meet someone...

### RANDOM NET ENCOUNTERS

- 1-2 Nothing
- 3 Random Program passes.
- 4 Friendly Netrunner
- 5 Hostile Netrunner
- 6 NETWATCH

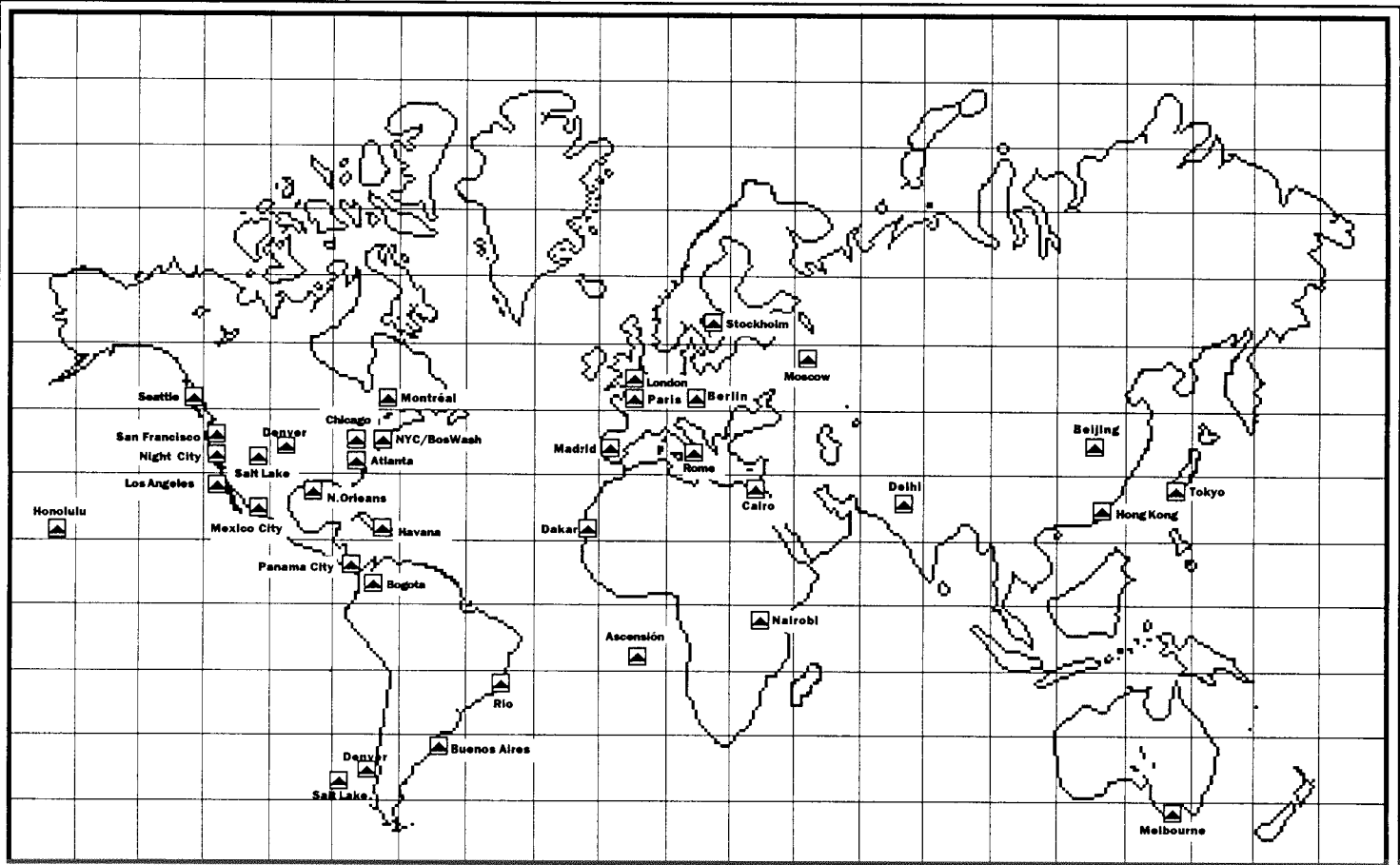

**WORLD NET MAP (REALSPACE)**

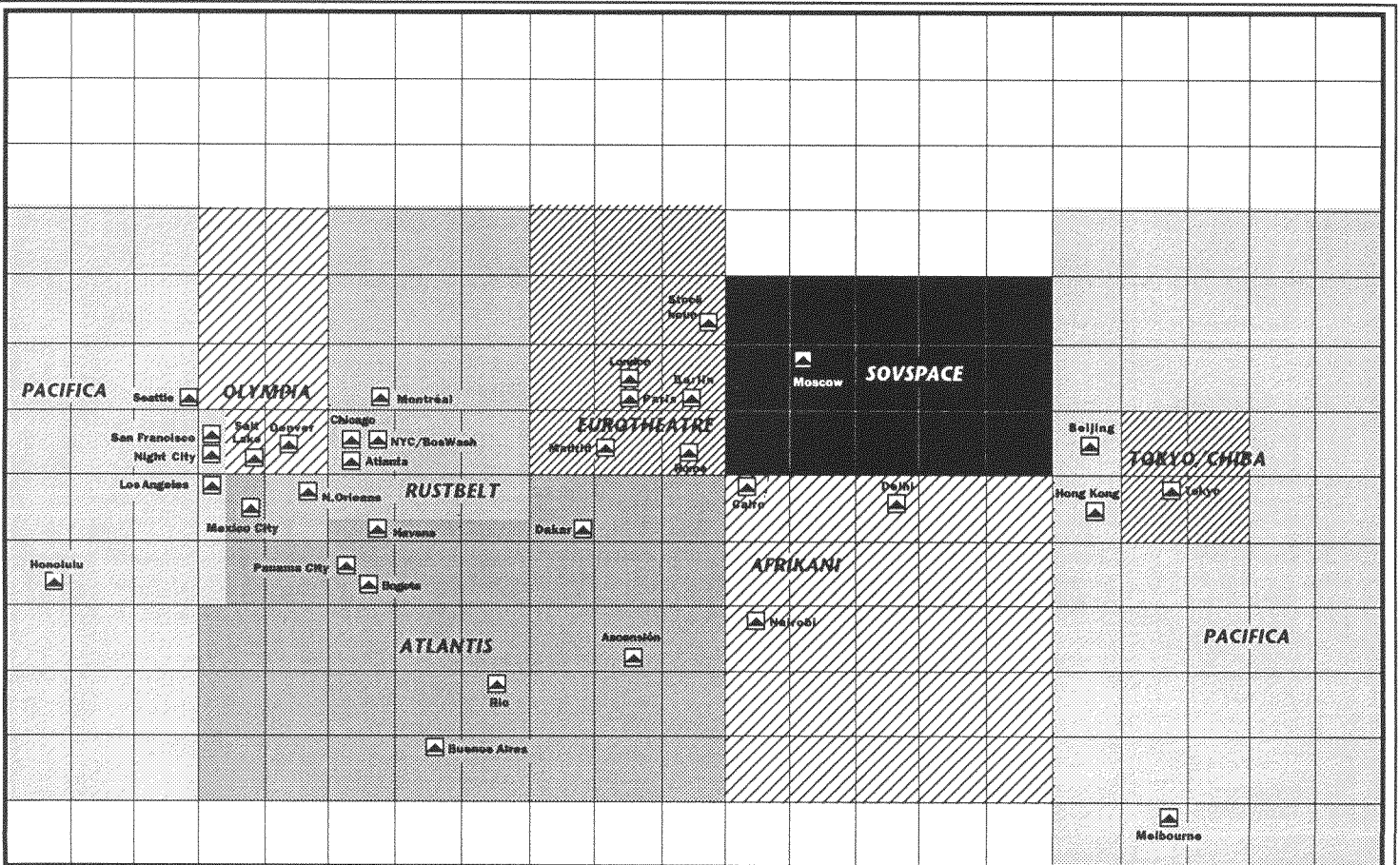

**WORLD NET MAP (NETSPACE)**



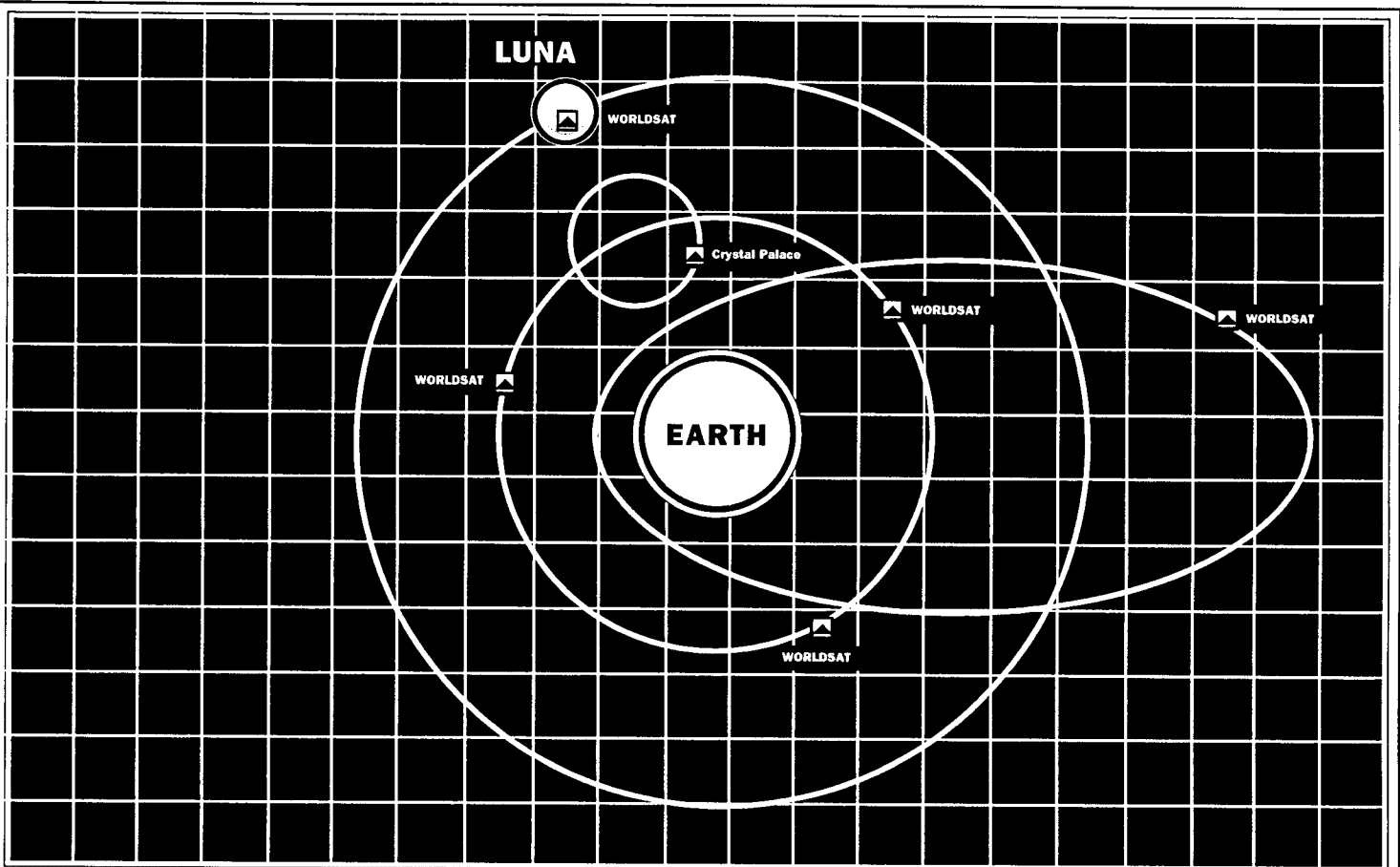

**ORBITSVILLE**

**LONG DISTANCE LINK GUIDE**

City	Region	Controlled by:	Security Lvl.	Trace Value
Ascension	Atlantis	Central American Federation	2	3
Atlanta	Rustbelt	NetWatch /US Govt. /EuroMarket Consortium	2	3
Berlin	EuroTheatre	NetWatch /EEC/ Eurocorps	3	3
Bogota	Atlantis	Central American Federation	1	4
Buenos Aires	Atlantis	Central American Federation	2	3
Cairo	Afrikan	Orbital Air	4	4
Chicago	Rustbelt	NetWatch /US Govt. /EuroMarket Consortium	2	2
Crystal Palace	Orbitsville	ESA	2	3
Dakar	Afrikan	None	2	2
Denver	Olympia	NetWatch /US Govt./Orbital Air	2	1
Delhi	Afrikan	None	1	2
Havana	Atlantis	Central American Federation	2	3
Honolulu	Pacifica	NetWatch /US Govt./EBM	2	2
Hong Kong	Pacifica	NetWatch/ Far Asian Co-Prosperity Sphere	2	3
Luna	Orbitsville	ESA	2	4
London	EuroTheatre	NetWatch /EEC/ Eurocorps	3	2
Los Angeles	Pacifica	NetWatch /US Govt./ Petrochem	2	2
Madrid	EuroTheatre	NetWatch /EEC/ Eurocorps	3	2
Melbourne	Pacifica	NetWatch /EEC/ Eurocorps	2	2
Mexico City	Atlantis	Central American Federation	1	2
Montreal	Rustbelt	NetWatch /EEC/ Eurocorps	2	2
Moscow	SovSpace	USSR / EEC	3	2
New Orleans	Rustbelt	NetWatch /US Govt. /EuroMarket Consortium	2	3
New York/BosWash	Rustbelt	NetWatch /US Govt. /EuroMarket Consortium	3	1
Nairobi	Afrikan	Orbital Air	2	2
Night City	Pacifica	NetWatch /US Govt. /Arasaka	2	2
Panama City	Atlantis	Central American Federation	1	3
Paris	EuroTheatre	NetWatch /EEC/ Eurocorps	3	2
Beijing	Pacifica	Far Asian Co-Prosperity Sphere	3	2
Rio De Janiero	Atlantis	Central American Federation	2	2
Rome	EuroTheatre	NetWatch /EEC/ Eurocorps	2	2
Salt Lake	Olympia	NetWatch /US Govt./ Militech	2	1
San Franscisco	Pacifica	NetWatch /US Govt./EBM	2	2
Seattle	Pacifica	NetWatch /US Govt./ Arasaka	2	2
Stockholm	EuroTheatre	NetWatch /EEC/ Eurocorps	3	2
Tokyo	TokyoChiba	Arasaka/ Zaibatsus/ Far Asian Co-Prosperity Sphere	3	2

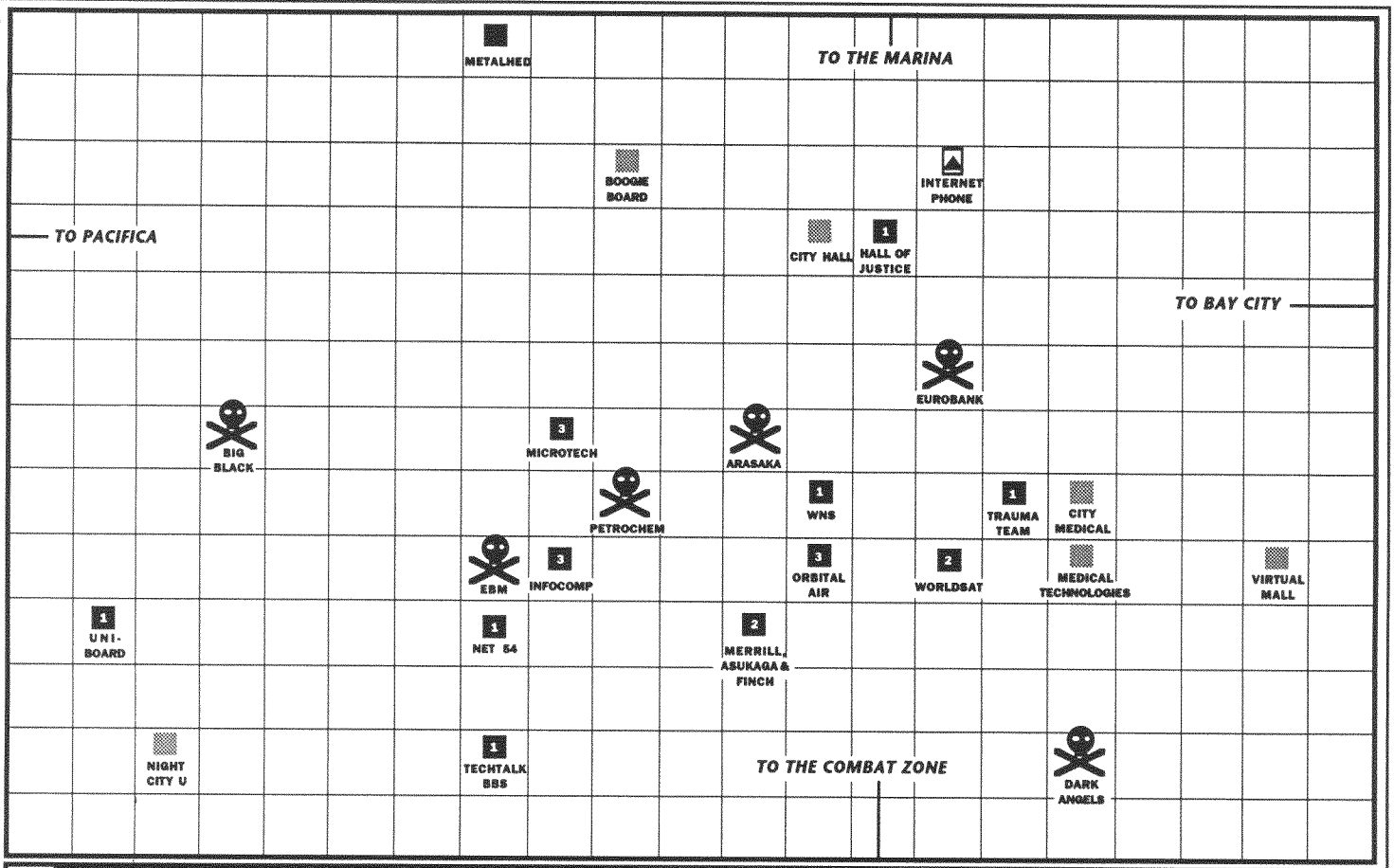

**CITY GRID MAP (NIGHT CITY)**

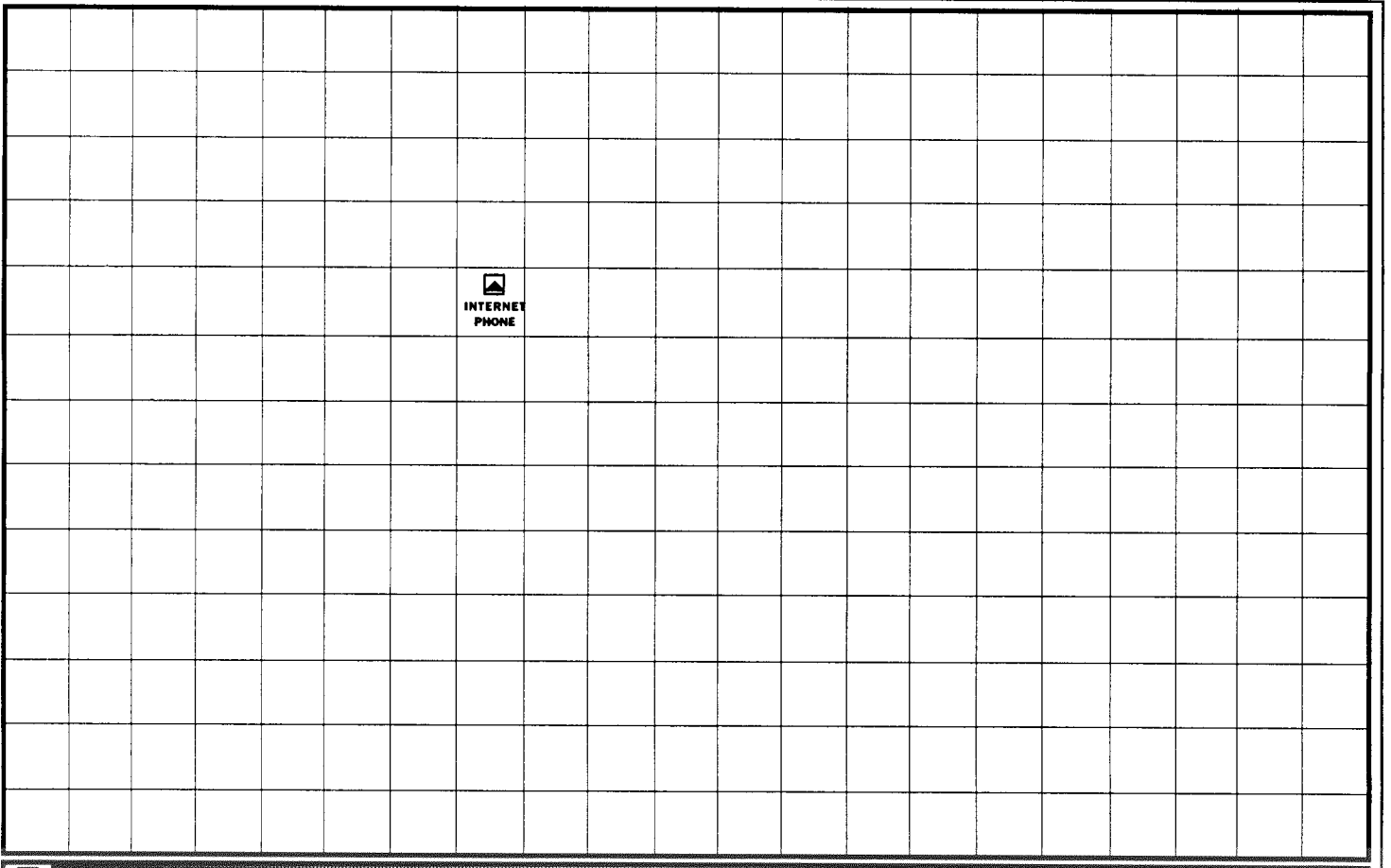

**YOUR OWN CITY GRID MAP**





### Subgrids

This is where most of your Netrunning action takes place. Once you've jumped through the LDLs and located your target on the City Grid, your netrunner will move to the specific Subgrid where that system is to check it out.

A **Subgrid Map** (pg. 151) covers about twelve square blocks, and is divided up into 10 meter squares. A system or Data Fortress (a heavily armored system) is constructed by filling up adjacent squares of the Subgrid in a sort of loose building form. The shape of the Data Fortress on paper is only roughly like its real appearance; systems can be shaped like Corporate Logos, colored polygons, Realspace buildings, abstract shapes or even personalities (such as Disney's titanic Mickey Mouse-shaped Data Fortress in the Chiba/Tokyo region).

When designing a **Data Fortress** (for more on this, see pg. 144), Referees should make some attempt to make the shape on the map roughly correspond to what the actual Netspace ICON of the fortress is, if only to make it easier on your players.

As in all Net movement, 'Runners move at a rate of five squares per turn. Movement, of course, is in straight lines, and cannot (obviously) pass through an obstacle unless you blast it to oblivion first.

Once you're down to the subgrid level, Netrunning becomes pretty simple. You try to get into the Data Fortress, either by getting through a Code Gate, or by blast-

ing through a wall. Once inside, you move from place to place, looking for Memories to loot and other useful things. Along the way, you'll encounter various anti-intrusion programs and traps, all of which are programmed to do something nasty to you, your software, or your deck. You'll launch your own counter programs to stop them from frying something important. For a sample of in-the-Net-action, check out the sidebar *Into the Net*, starting on this page.

## The Menu

So far, we've talked about moving around in the Net. But not all Netrunner activity has to be flat-out Netrunning; in fact, the most useful Netrunner tasks can happen without only minimal interfacing. Most of the time, you're not going to be deep in the Interface at all; you're going to be running around the Street with your gangboys, backing a high-risk play for the big euro. The middle of a firefight is no place for you to go sleepwalking, chombatta.

That's where the Menu comes in. The Menu is a list of commands that you use to tell your deck what you want to do. Each command

### INTO THE NET

So enough talk. Let's take a little trip, okay?

You begin your run in your one-room flat in the Night City 'combat zone.' You're packing five programs: a *Jackhammer*, a *Wizard's Book*, a *Copycracker* and two *Demons*. One *Demon* is a *Succubus II* with *Killer* and *Worm* subroutines. The other is an *Imp* with *Invisibility* and *Hellbolt*.

You hit the switch and plunge headfirst into the Net. Instantly, you are engulfed in a wall of swirling static electricity. You look down at your ICON—you're a chromed, humanoid shape wearing futuristic battle armor. Your face reflects in your mirrored body—your eyes glow an eerie green. Below you is a bright neon landscape representing the Night City Grid. In the distance is a blazing blue diamond shape, emblazoned with the logo of the *Internet Telephone Corporation*.

You fly down the pathway towards the blue diamond. Your objective is the Los Angeles office of *Microtech* computers, so you streak towards the glowing arrow of the Long Distance Link. You don't expect much trouble getting in; the Phone Company doesn't use any serious counter-intrusion software, and Night City only rates a Security Level of 2 anyway. You activate the Menu with your mind and run your LDL LINK. *Faked 'em again*, you think, blasting on through.

You enter the LDL. The glowing violet arrow sinks through the floor—it's like moving downstairs on a fast elevator. Lights blur around you as you fall towards the distant trunk line. You drop until you see a brilliant red, neon shape rising to meet you—a streaming river of red light, like a superhighway. It angles away into the starstrewn darkness towards the horizon. At intervals, you can see complex grids and shapes of multicolored neon structures representing cities. You reach the red highway and hurtle above it at lightspeed, passing through spidery light sculptures representing cities along the trunk line. A huge network of neon rises in the distance—Los Angeles. You bank over another huge violet arrow—a long distance link—and land. The arrow swiftly rises into the neon maze, linking you to the Los Angeles City Grid. All in seconds.

As you exit the LDL, a figure flickers by. It's a slender woman wrapped in gauzy, iridescent mist. Her eyes and fingernails are pinpoints of light. She smiles in recognition—you know her by her handle of *Razor Annie*. You smile back, and she passes you on her way to the LDL.

You step out into the vast, cool-blue space of the LA city grid. Far above your head, you can see hundreds of neon logos, each representing a different megacorp. You spot the familiar red-barred circle of *Microtech*, and rise towards effortlessly.

The *Microtech* logo stands before you like a bright door. A white pinpoint marks the entrance to its Code Gate. Beyond it, looms a dark, feral shape—a *Watchdog* program, hunched over, waiting for intruders. You activate your *Imp*—a spinning, bright ball of orange light appears—and kick in its *Invisibility* subroutine. The *Imp* flattens to a thin, glittering sheet of energy, draping itself over you. The *Invisibility* is successful—you walk past the *Watchdog* and up to the Code Gate.

Although you've spent days researching *Microtech*, nothing you've found has given you a clue to the access code. It's going to take brute force. You unlimber the *Codecracker*; no good. How about the *Wizard's Book*? No go there—you shoulda known, trying to crack an computer company's Fortress! You just can't crack that Code Gate.

Time to call up the *Jackhammer*. The *Imp* swirls around your head as you work, making a few rude beeping noises. The *Jackhammer* slams down the wall. Before you move on, you decide to play it safe. *Jackhammer*'s noisy; you activate the *Imp*'s *Speedtrap* subroutine. It shapeshifts into a flat viewscreen. No metallic monster looms in the screen, so the area must be clear. You step through the hole you've made—

Whammo! The *Speedtrap* was wrong! A *Killer* leaps up and attacks your *Imp*. You curse, realizing you should have packed something to counter! You know the *Imp* won't survive this, so you activate your *Succubus* instead, pulling up its own *Killer* subroutine. Instantly, a chromed goddess appears, her eyes flashing. She shifts form into a powerfully built, metallic samurai, who attacks the opposing metal warrior. Their sabers clash—and the system's fails. You've saved your *Imp*—this time. "Good going, stucc." the *Succubus* says to you, as you move on.

Hulking around the next corner is the massive form of a *Manticore*! You try invisibility again, but it fails. The *Manticore*'s powerful talons attack your *Imp*—the *Imp* fails its rolls and is vaporized! In the next turn, you activate the *Succubus*' *Killer* routine. The metal-clad warrior springs forward and attacks the monster, slaying it in a flare of light. Close call.

You've lost your *Invisibility* and *Speedtrap* programs, so you move cautiously. You carefully move through one of the Central Processors, looking for trouble... You figure you could use the CPU to hit the workstations and see who's logging on. But that's not going to give you a lot of good data. What you want are the plans for *Microtech*'s new military computer. That'll be in one of the Memories. You press on.

Entering the first Memory area, you encounter another *Watchdog*. Wait!—it's a *Bloodhound*! It lunges out to backtrack your trail. You activate the *Killer* routine and the armored warrior rezzes into reality—in moments, the techno-samurai kills the hound before it can trace your path. The *Killer* melts back into the form of the beautiful chromed *Succubus*. She winks.

There's nothing in here but accounting records; useful, but nothing you can't go back for later. Cautiously, you move ahead to the next Memory. Empty. What gives? Obviously someone wanted to spend their money elsewhere in the Fortress. But where? You move like a shadow to the next Memory—

Hellhound! The huge black cloud leaps at you, but you throw the *Killer* routine in its way. Your metal warrior staggers and misses! The system rezzes another *Killer*, which attacks your own program. Flash! Your *Succubus* vaporizes with a despairing cry. You're alone without a program to cover you. The *Killer* waits. The Hellhound's eyes glitter gleefully as it reaches out to stop your heart—

You punch out.

You're sitting in a chair in front of your desk. The seedy flat is silent except for the faint hum of your cybermodem as it powers down. Your hands shake as you think about your narrow escape. *Next time, you think, I've gotta bring along some bigger guns. That was too close.*

The entire run has lasted less than two minutes.

activates a preprogrammed function of the deck.

The Menu is always present when you jack in; all you have to do is think about it, and it instantly appears, floating like a one-dimensional image in your field of vision. You think the command, and you're off.

Back to the Street. Two of the most important commands of the Menu don't require you to go into the Net at all; you can call on them from Realspace.

The first is LOCATE REMOTE. With this command, your deck immediately scans your immediate area (up to 400 meters), and locates every Remote system connected to the Net. It then displays a list of all the possibilities, their locations and type, on the Menu.

Now comes the second most important command: CONTROL REMOTE. When activated, this command tells your cyberdeck to search its Memory for a program to allow it to take control of the remote you've selected. These Controller programs are designed to take over specific types of remotes; a *Viddy Master*, for example, will only control a videoboard, while *Hotwire* allows you to control remote controlled vehicles.

When the cyberdeck locates the right Controller program (which you may not have), it runs the program and attempts to take over the Remote (a roll equal to or lower than the Controller program's Strength on 1-10). If the roll is successful, you can direct the remote to do anything it normally could do as part of its operation (cars drive, AV's fly, videoboards display desired images, etc.)

This can be a real advantage. Trapped by superior firepower? How about taking over that nearby robo-cab and using it to ram the enemy position? Armored door got your team stymied? Maybe it's computer controlled, and you can open it from inside. Want to spot that Solo team up ahead? Use a TV camera and hidden mike to locate them, then use your *Dee-2* program to tell that automated crane to crush their car.

See what we mean? Now, we don't wanna hear you Netrunners whining about sitting at home on a Friday night anymore.

### The Rest Of the Menu

**LOG ON/OFF:** The rest of the Menu commands are designed to be used while in the Net. They are activated when you choose the LOG ON/OFF command on the list. This punches you into the Net.

To LOG OFF, you must make a roll equal or lower than 8 on 1D10. Logging off drops you back into Realspace. Some programs are designed to stop you from doing this (after all, NETWATCH would like you to stick around while they talk to you). These programs jam your cyberdeck's CPU, preventing you from jacking out for 1D6 turns.

**RUN PROGRAM:** This command activates any program you call on, as long as you have it in your deck's memory. The program instantly goes into action, performing its function as designed (you hope).

**LONG DISTANCE LINK:** This command is used to transfer between two long distance switching systems (or LDLs). When activated, the deck attempts to tell the Phone Company that the call you're making is a local call (even if it isn't) and shouldn't be charged to your phone bill. A successful attempt requires that you roll a 1D10 value equal to or higher than the Security Level of the LDL you're trying to fake out.

As it comes from the factory, this option is actually designed to tell Internet that this is a cyberdeck signal, requiring that the call be carried on a laser land-line. However, reprogramming this command is one of the first things an enterprising Netrunner does, even before he plugs his brand new deck in.

**COPY:** This command tells the deck to make a copy of any program or file the Netrunner has access to. You use this, for example, to make your own copy of Saburo Arasaka's little black book (just in case you find yourself dateless in Osaka on a Friday night). A copy is automatically stored in your deck's memory (assuming there is space).

One of the nifty things about cyberdeck designs is that they have terminal-emulation chips included in their construction, making them tiny terminals inside the computer. This design function allows a friendly Netrunner to diagnose and work within his own Data Fortress. It also allows an unfriendly Netrunner to give the CPU of the system his own commands:

**ERASE:** This deletes any program or file from your personal deck or from any system you are currently in. ERASE is used when you don't have enough space in your deck for Saburo's black book and you just *have* to have it.

**READ:** This command allows you to browse the table of contents of any file you may find in a system memory, or through the contents of that file. Most of the time, however, you aren't going to want to waste time reading the actual contents; you'll just make a COPY and run for cover.

Note: occasionally, very devious types take advantage of this by planting huge files in a system memory with seductive labels like SECRET PLANS TO RULE THE EARTH. The file, of course, contains nothing but useless garbage, but a really gullible Netrunner will invariably dump everything else he has just to carry this treasure back.

**EDIT:** This command allows you to change, write into, re-write or otherwise alter the contents of a file.

**CREATE/DELETE:** This command activates a special program called *Creator*. *Creator* is used to generate virtual constructs and realities within memory. For more on *Creator*, check out *Virtually There*, pg.160. In the meantime, what you should know is that CREATE allows you to make small objects in Netspace (relatively non functional ones, as guns cause no damage and most electronic hardware doesn't really do anything), and that DELETE allows you to de-rezz the same. Safeguards in *Creator* prevent you from pg. someone else's creation, however. This is actually a good idea; do you really want to be the guy who accidentally de-rezzed Dream Park Corporation's *Virtual Theme Park*?

## Combat

*Edger skated around the edge of the Kiroshiyu data fortress, his Cosmowarrior ICON leaving a sparkling wake. Behind him, the Kiroshiyu system rezzed four Hellbolts into existence. Edger muttered something vague and obscene in gutter Japanese, as he brought the Menu up in his mind. A quick choice— run the Killer, he decided. Instantly, the lean, metallic shape rezzed behind the fleeing Netrunner and streaked off on an intercept course towards the four seething energy globes...*

### Initiative

The first thing to determine in a Net combat is who goes first. This can be critical, as most offensive software can seriously incapacitate or kill in a single turn. To determine who will act first, compare:

**COMPUTER'S INT+ 1D10**  
**VS**  
**NETRUNNER'S REF+DECK**  
**SPEED+ 1D10**

When there is more than one Netrunner or system involved in an attack, each combatant must make it's own initiative roll, taking turns from highest to lowest total. Like normal combat, you may elect to hold your action until later, or even set up an ambush.

### Rounds & Actions

A Netrunner combat round is one second long. During this time, a Netrunner can take one action (unlike a normal combat round, in which a character has three full seconds to cram in a lot of actions). This action can be anything listed on the Menu in addition to movement. For example, Edger elects in his combat round to move five spaces away from the *Hellhound* and RUN a program (in this case, a *Killer*) to attack his enemy.

Computers, of course, are a lot faster than humans. Single-CPU systems perform only one action per turn. **A computer may perform one extra action per turn for every two additional CPU present in the system.** A really powerful computer could activate two, three, four or more programs to attack a single Netrunner.

This is why Netrunners team up to tackle big systems.

### Range

Range in the Net is simple—you have to be able to see the target in order to hit it. As a rule, you can see anything within 20 spaces of your position, unless it's blocked by some other obstacle (as determined by the Referee of the game). You can attack anything else within 20 spaces as long as you can see it and it isn't blocked by another object.

### Movement

As discussed before, Netrunners move at a speed of five spaces per round. But how fast do programs move, if ever?

Most programs are limited to staying within the confines of a system. However, once they spot you, they can move anywhere within the system to intercept, also moving at a speed of five spaces per round. A program can pursue a Netrunner anywhere within its home system, and up to one space outside of it. It will then break off the attack and go back to its original position.

*Hellhounds, Bloodhounds and Pit Bulls* have no such restrictions; they are designed with a tracing function that allows them to move away from their home system and follow you anywhere. The only way to ditch one of these monsters is to jack out and hope the pursuer isn't able to make a successful **Trace roll** on you. Otherwise, it'll be waiting the next time you log on in that location of the Net.

**Trace Rolls:** A Trace roll is made by comparing the program's STRENGTH+1D10 to the total of all the Trace Values of all the LDLs you passed through during your run.

*Example: Spider's most recent run has taken*

*her through Salt Lake (1), Denver (2), New Orleans(3), Havana (3), Bogota (4) and Rio (2). In Rio, she encounters a Hellhound (Strength 6) which attacks her outside of the Petrochem's new Data Fortress. Spider jacks out, and the Hellhound tries to run a trace back to her original position. It must beat a total of fifteen (1+2+3+3+4+2=15) in order to make a successful trace. That Hellhound better roll a 9 or 10, or it's going to be out in the cold.*

### Stealth and Evasion

Like you, a program can attack anything it can see. As programs have no "front" or "back" facing (what's the front of a string of code?), this means they can see you coming in any direction, all the time.

Well, maybe. This is where stealth and evasion come in. When you are running a Stealth or Invisibility-type program, the opposition has to make a special roll to see if it is aware of you:

**ATTACKING PROGRAM'S STR +1D10**  
VS.  
**YOUR PROGRAM'S STR +1D10**

### Detection

The other side of Stealth and Evasion is detecting the unseen. To use a Detection program, the Netrunner must make a roll exactly as when using a Stealth/Evasion program above. Note that Netrunners can use Detection programs against the Stealth programs of other runners and vice versa.

### Attacks Against Systems and Cyberdecks

Some programs are designed to attack only systems and cyberdecks. They operate by penetrating the data walls that protect the system, then running their attack programs. Anti System attacks include Intrusion and Anti-System Programs. These attacks are made with the formula:

**ATTACKING PROGRAM'S STR +1D10**  
VS.  
**CODE OR DATA WALL'S STRENGTH +1D10**

If the attacking program's roll is greater than the data wall's, the wall is penetrated.

Some **Intrusion** programs are "noisier" than others. *Hammer* will always alert the system to a break in, allowing it to send offensive programs to deal with the break. *Jackhammer* will alert the system on a roll of 8,9 or 10 on a 1D10 roll; this check is made after the program is run, whether the wall is breached or not. *Worm* will alert the system on a roll of 9 or 10 in a 1D10 roll.

**Anti-system attacks** are also made against the data walls of the system. The formula is the same as with Intrusion attacks. If the Anti-system program's roll is greater than the data wall's, the wall is penetrated and the program takes effect in the next turn.

For example, if a *Poison Flatline* breaks through a level 5 data wall, in the next turn, one of the system or deck's memories will be erased each turn until the *Flatline* is stopped. This could be done with a *Killer* or other anti IC program.

**Decryption programs** attack *Code gates* and *file locks*. Code gates are entryways into a computer system. File locks are often placed on files to protect them from entry. Decryption attacks are made as are other anti-system attacks.

### Anti-Personnel Attacks (Stuff That Can Kill You)

**Anti-personnel** programs physically attack the Netrunner, either through physical damage or through attacks on the Netrunner's stats. These can be used by both computer systems and Netrunners.

Anti-personnel attacks are made with the formula:

<p><b>DEFENDER'S PROGRAM STR+ INT+INTERFACE+1D10 VS. ATTACKER'S PROGRAM STRENGTH +INT+ INTERFACE+1D10</b></p>
---

On an equal or higher roll, the Attacker will win the combat exchange. *For example,*

*Spider is attacked by a powerful Brainwipe program. She raises her own Force Shield counterprogram. The rolls are Spider 18, the computer 17. Spider successfully thwarts the Brainwipe.*

*In the next turn, Spider goes on the offensive, launching a Killer at the Brainwipe. Her total roll is an 18; the system's roll is only a 15. The Brainwipe takes 5 points in Strength Damage. As it's only a Strength 4 program, it de-rezzes.*

### Attacks Against Programs (Anti-IC)

**Protection programs** are designed to ward off attacks on the Netrunner. On a successful defense roll, the attacking program is deflected and no damage is taken. For example, a successful defense with a *Shield* will stop a *Hellhound* from killing the Netrunner, but will have no effect on a *Killer* attacking a Netrunner's *Liche*. If the *Hellhound* is not eliminated, it will be able to attack again.

**Anti-IC programs** are used to attack other programs (such as *Killers* attacking *Hellhounds*). When a successful attack is made, the defending program loses a certain number of Strength points based on the program type. If the defending program's Strength is reduced to 0, it is "de-rezzed" (destroyed).

### Controllers & Utilities

Although they don't really count as Netrunner combat, **Controllers** and **Utilities** deserve a quick mention. **Controllers** can take control of a remote by making a 1D10 roll equal to or lower than the Strength of the Controller program.

**Utilities** operate by rolling a value equal to or lower than the Strength of the Utility program. If successful, the Utility performs it's entire function. For example, running a *Packer* utility will automatically reduce the size in MU of any designated program(s) by half. *ReRez* would completely restore a damaged program if successful.



### PARTS & PROGRAMS

A Central Processor (or CPU), is the brain of the computer; it does all the thinking tasks the system is ordered to perform. Unlike humans, a computer can have more than one "brain"; large Data Fortresses may have as many as a dozen, all working away in unison as the computer performs various jobs.

Processors in the 2000's differ from those of the 20th century in that they are closer in design to artificial intelligences. This gives them the capacity for intuitive thought and innovation, but makes them more prone to make errors in judgement.

Memories are where you store things that the computer system will need to operate. They are the most important part of the system next to the CPU.

Data Walls represent the physical hardening of the computer against intrusion. A Data Wall covers the top, bottom and sides of a system. Really well defended systems are called Data Fortresses.

## DESIGNING DATA FORTRESSES

A Data Fortress is any type of computer system that is defended by programs and armored with data walls. A key part of refereeing the Net will be creating Data Fortresses for your players to plunder (or die trying).

Start by making a photocopy of a Subgrid Map (pg.161) to work on. You can use regular quarter inch graph paper as well, as long as you letter the top from A to T and the sides from 1 to 20 for mapping coordinates.

### Central Processing Units

Choose how many CPU you will have in your system, paying 10,000 eb for each one. Pick a clear space on your graph paper and place each of your CPUs in a square of the grid, using the symbol for a CPU (a circle with an "X" through it).

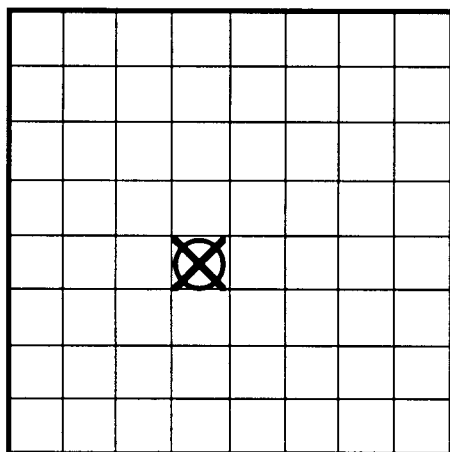

FIGURE 1: THE CPU

**Computer Intelligence:** For every CPU, the INT of the computer is raised by 3 points. INT is important; it's what the computer used in lieu of REF and other stats when performing tasks; it's also used when the computer brings it's *Interface* skill into play to make attacks or defenses. The maximum number of CPU you may have on any one system is 7.

### Artificial Intelligence

When a system has achieved an INT of 12 or greater, it is considered to be an Artificial Intelligence (AI), capable of independent action without a human overseer. If you have created an AI, you will need to determine just what it is like (after all, AIs are almost as much characters as they are computer systems), and what sort of ICON it uses to represent itself in the Net.

#### Personality

**Friendly, curious:** The AI is motivated by an interest in what happens around it. Like a child, it is trusting and friendly. However, like a child, it can lash out with incredible violence towards those who betray, threaten or hurt it.

**Hostile, paranoid:** This AI is motivated by it's survival, and treats all incursions as a threat to that goal. It will tend to attack when possible, withdraw and hole up when not.

**Stable, intelligent, businesslike:** The AI sees itself as an adult dealing with other adults. It will not act out of fear, but out of rational self interest. It will attack only if it sees it's duty compromised or safety threatened; it will then tend to go for the least violent solution to the threat.

**Intellectual, detached:** The AI is a thinker. It will watch and observe whenever possible, compiling as much information as possible. It is more likely to study the intruder from a distance, eliminating it ruthlessly when the intruder becomes a threat.

**Machinelike and inhuman:** The AI has never seen a reason to develop a human persona; what human like qualities it possesses are done only as a way of dealing with it's irrational masters. The AI will deal with threats in an efficient, deadly manner.

**Remote and godlike:** The AI is fully aware of how limited humans are in relation to it's powerful mentality. It deals with people as though they were small children who aren't too bright. Intruders are dealt with through simple, direct, usually non-fatal methods. Repeat offenders are considered to be too stupid for their own good and are eliminated the way a human crushes a bug.

**ICONS**

**Human:** The AI chooses to look like a normal human, to better interact with others. The human ICON chosen can vary wildly, depending on the AI's personality, but all appear as real humans you might meet on the Street.

**Geometric:** Forget all this anthropomorphology. The AI manifests itself as shapes, colors and energy fields. Occasionally shapes are strung together to make a symbol or other image.

**Mythological:** The AI is interested in human archetypes and knows that certain types can cause fear or awe in humans. The AI appears as a mythological figure; a dragon, demon, angel, mystic hero or monster, all out of some type of human mythology.

**Voice Only:** The AI only appears as a voice emanating from all over it's Data Fortress. The voice may be powerful and booming, or tiny and childlike, depending on personality.

**Technic:** The AI appears as a construct out of science fiction. This could be a robot or other metallic warrior, or an assemblage of high tech shapes.

**Humanoid:** The AI appears as a humanoid shape, but not necessarily human. This would include aliens, manlike monsters and other humanoids.

**Memory**

With each CPU, you will get four **memories**. Memory is where you will store Programs, Skills, Files and Virtual Realities (more on all of these later). Memories must be placed in squares adjacent to each other or the CPU (see Fig 2):

**Memory Units:** Programs, Skills, Files and Virtual Realities are all measured in a value called **Memory Units (MU)**. Each individual memory can hold 10 Memory Units. This means for example, that a single memory might hold a couple of 1 MU Files, a couple 2 MU Programs, and a 6MU Virtual Reality before it was filled up.

A good idea for keeping track of your memories (and their contents), is to assign

**PLAYING AN AI CHARACTER**

An AI is very much like a real person; it has the ability to conceive of new ideas, make long range plans, and act to further it's own desires.

However, what *motivates* a computer isn't exactly what would motivate you or me. Computers don't have glands or emotions; there isn't much chance that you'll meet an AI who has a thing for a good looking character because the wiring just isn't there.

What generally motivates computers is curiosity or survival. An AI might build a series of complex virtual realities just to study the humans who visit and play in them. It might track a single Net runner for years, just because it's curious as to why the 'Runner does what he does. If a netrunner intrigues an AI, there's no telling what the AI might do to help the "Runner — or hinder him. Just to see what happens.

On the other hand, AI's are also programmed to promote their own survival. Anything that restricts the AI from getting information, electrical power, or access to parts is considered a threat to be dealt with. An AI may deal very harshly with intruders to it's system, because they threaten it's programs and memories.

Also, anything that might cause the AI's human operators to turn it off will also be a threat; if the AI is not vigilant, there's always a chance that it's owners might trade it in for a more aggressive computer.

Personality-wise, AI's tend to be distant, powerful and unpredictable. They play by their own internal logic, which is often skewed and hard to decipher. AI's are the dragons and demigods of the Net; heavy duty players whose reasons are often unfathomable to mere humans. While AI's *could* be brought into a *Cyberpunk* game as player characters, we recommend that they be treated exclusively as Referee characters instead.

**Code Gates** are openings through **Data Walls**, permitting entry to anyone who has the proper identification codes or passwords.



**Long Distance Links (LDLs)**, as described earlier, allow instantaneous movement of data (or netrunners) over long distances. If an LDL is in a computer system, this means that this LDL leads to another computer system directly connected to this one.



**Terminals** are input/output devices used to put information into your system, or to get it out again. You use the keyboard part to type in instructions, and the screen part to get messages back from the computer.

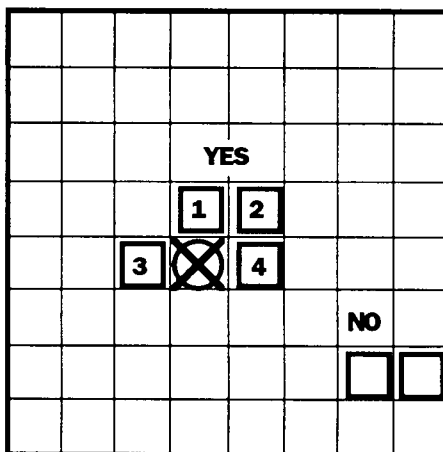

**FIGURE 2: MEMORIES**

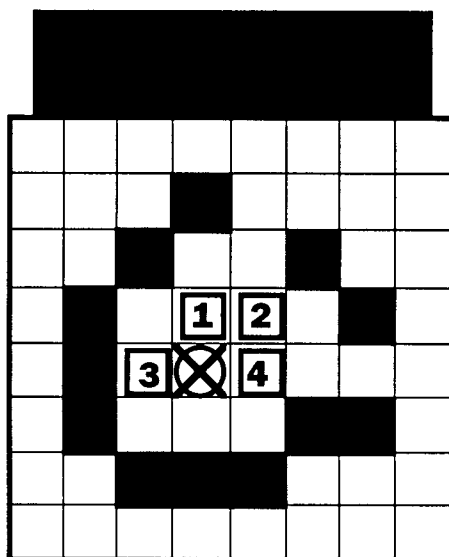

**FIGURE 3: DATA WALLS**

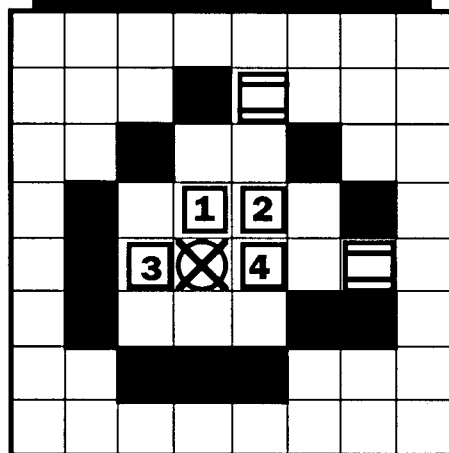

**FIGURE 4: CODE GATES**

a number value for each one (this is why the symbol for a memory is an empty box). For example, in our sample computer in Fig. 2, we've assigned each memory a value from 1 to 4.

### Construct Data Walls

The data wall encloses your system on all sides, top and bottom. Its strength is equal to the number of CPU present, plus 1000eb spent for every additional level added to the wall, up to a Strength of 10.

*For example, with three CPU, Syntek 15 has a Strength 3 data wall. However, 3000eb are spent to upgrade this wall to a Strength 6.*

Constructing your data walls on paper is a process of blacking in squares on graph paper (or a photocopy of a Subgrid Sheet). The wall can be in any shape, and cover as much area as desired (although putting a lot of empty space in a system probably is a waste of time. Write the Strength next to one corner of the wall.

### Place Code Gates

Code gates are how information moves between the Net and the system. Each CPU comes with one code gate. Additional ones can be purchased at 2,000eb each.

Code gates start with a Strength of 2. However, for 1,000eb, you can raise a code gate by one level of Strength, up to level 10. The level of the code gate is marked by the number of lines crossing it's symbol.

Place your code gates in the openings between data walls (see sidebar example).

### Pick Skills

Like humans, computers have skills. These skills are programs not all that unlike chipped human skills; the difference is that they are a lot more powerful than biochips. Computer skills start at a level of 4 and have a base cost of 200eb. For an additional 100eb, you can raise a skill by one level, up to a total of +10.

**For every two CPU, pick five skills from the list below. You may also create your own skills for your computer, as long as**

they do not involve a physical component, such a running or leaping (a computer could fly an AV-7 or paint a picture, as long as it had the proper remote controls (more on this later). All computer skills are performed using the computers INT score in lieu of a TECH or REF stat.

### COMPUTER SKILLS

Accounting  
 Anthropology  
 Botany  
 Chemistry  
 Composition  
 Cryotank Operation  
 Diagnose Illness  
 Driving  
 Education & General Knowledge  
 Gamble  
 Geology  
 Heavy Weapons (as a mounted weapon)  
 History  
 Language  
 Library Search  
 Mathematics  
 Operate Hvy. Machinery  
 Paint or Draw  
 Pharmaceuticals  
 Physics  
 Pilot  
 Play Instrument (if electronic)  
 Programming  
 Rifle (as a mounted weapon)  
 Stock Market  
 Submachinegun (as a mounted weapon)  
 System Knowledge  
 Teaching  
 Zoology

### Create Key Files

Files are where you keep the important information of a computer. Secret plans, lists of enemies, the missing three minutes of the Watergate tapes, etc. Often, a file will contain useful information or clues to a problem facing your *Cyberpunk* team. At the very least, a Netrunner can sell or trade the contents for something useful, which is why they took up this dangerous occupation to begin with.

At this point, you'll want to decide what kinds of files are in your computer system and where you'll store them. Files are always placed in a memory for storage. Each file (no matter what type), uses 1 MU.

There are six types of files:

**Inter-Office:** These files are records of memos, letters to clients, gossip, games and other

generally useless stuff that gets stored on any large computer system. Most of it's worthless, but occasionally a savvy Corporate will bury something in the garbage just because he knows no one will look there.

**Databases:** These are lists; lists of names, phone numbers, figures, records, etc. A database might contain the entire list of employees of a corporation, or a list of clients who regularly receive company catalogs. You check out a database to find out a particular person's phone number, for example.

**Business Records:** These are actual business documents. They would include important meeting notes, memos, reports and so on. Most business information is stored here. You might look in Business records to find a copy of the Arasaka sales report for May, 2019.

**Transactions:** These are usually things that involve money; checking accounts (write yourself a check and mail it to your safe box), financial records (wipe out that bill you owe Militech for the five new missile launchers) and orders (tell Procurement to buy you a new AV-7 with all the options). As you might have guessed, this is where most Netrunners go to steal money or order plane tickets.

**Grey Ops:** These are secret records and orders. In Grey Ops, you might find records of bribes, slush funds, blackmail information, trade secrets, espionage information, etc. This stuff is valuable; it's also well protected.

**Black Ops:** These are top secret records and files. Assassination orders. Murders. Corporate sabotage. The stuff that's dynamite in the right hands. Watch out; this stuff is always guarded by lethal defenses.

Inside each file are hundreds of documents; individual pieces of information up to 100,000 pages long. A file can hold a lot of documents; for example, the file BLACK OPS might hold the following:

- ORDER TO ASSASSINATE PRESIDENT
- PEOPLE WE HAVE BLACKMAIL ON
- BRIBES TO FOREIGN AGENTS
- SECRET VIRUS PROJECT
- CHAIRMAN'S SECRET SLUSH FUND

By using the READ option of the Menu, you can get a list of all the documents in a file.

Some files may be **locked**. This means a special code has been attached to the file;

you need the right code to read the file. You can try to figure out the code indirectly (always a good roleplaying option, as the players search the Chairman of the Board's trash cans for a scrap of paper and quiz everyone who knows Saburo Arasaka to discover the name of his childhood pet because the Ref said it was a clue). Or you can brute force your way into the file by using one of the many decryption programs available (*Codecracker*, *Wizard's Book*, *Raffles*).

The best way to keep track of your files is to write the contents down on a 3x5 card or other scrap of paper, making sure to also write down what memory it is stored in.

### Virtuals Are Their Own Reward

A virtual reality is a miniature universe, created by use of advanced imaging technology and direct brain link. Activated by a Netrunner entering their memory area, they appear as pocket environments, complete in every detail.

Virtuals are used as conferencing centers, recreational environments for corporate staff, offices where people on other sides of the world can meet via Net-conferencing to work on a project, and even realistic simulations (to train solos and pilots). Although we'll go further into virtual realities further on (pg. 170, to be exact), you'll need to know enough to decide if your system currently has one. Like other things in the system, virtuals take up MU and must be stored in a memory; however, a large virtual can be broken up over several adjacent memories if need be.

Virtuals come in six sizes:

**Virtual Conference Room:** a misnomer; this could be any average size room where people can meet and talk.

**Virtual Office:** this is any larger space, usually including a couple of conference rooms, where Net-conferencing groups can meet and work.

**Virtual Rec-Area:** this is a small recreational area; a beach, spa or other small retreat not much larger than a city block. Virtual rec-

areas are usually not very complex; a couple small rooms and a lot of empty space.

**Virtual Building:** this is a large scale construct, equivalent to about a 10 story building. Virtual buildings are used when a large number of people must conference together via the Net. A good example of this would be the *Hunt Club*, a virtual building constructed as part of a Netrunner's club called the Master Hackers. It is basically an English Tudor mansion with surrounding gardens, libraries and carriage house.

A virtual building need not always be a building; the U.S. Navy maintains several virtual aircraft carriers for use as training simulators.

**Virtual City:** these are literally cities. They are used to simulate total environments. For example, training disaster personnel to deal with a virtual San Francisco earthquake is a lot easier than using the real thing. Virtual Cities are extremely rare; a rich man's toy.

**Virtual World:** as far as *you* can tell, this is a totally developed universe. Virtual worlds are constructed as elaborate vacation spots (a mental version of the 20th century TV show *Fantasy Island*), training simulations of large events (such as war zones or alien environments), or as the playthings of rich and powerful people who like to play god. For example, the ESA has used robotic braindance information to construct a huge Mars virtual world; some 400 colonists are currently using it to train for the coming Olympus Colony Project. On the other hand, Saburo Arasaka has a huge recreation of 16th century feudal Japan which he uses to impress his friends (and as a training ground for top Arasaka operatives).

Each Virtual has a Memory Unit cost based on its type, as well as an eb cost.

Type	MU Cost	EB Cost
Virtual Conference	1	10,000
Virtual Office	2	50,000
Virtual Rec-Area	4	100,000
Virtual Building	8	500,000
Virtual City	16	1,000,000
Virtual World	32	10,000,000

**Realism:** Realism is a measure of how much like the real thing the virtual is. There are five levels of realism.

**Simple:** a cartoon. Bright shapes, colors, funny noises.



# SAMPLE SUBGRID MAP (FRONT)

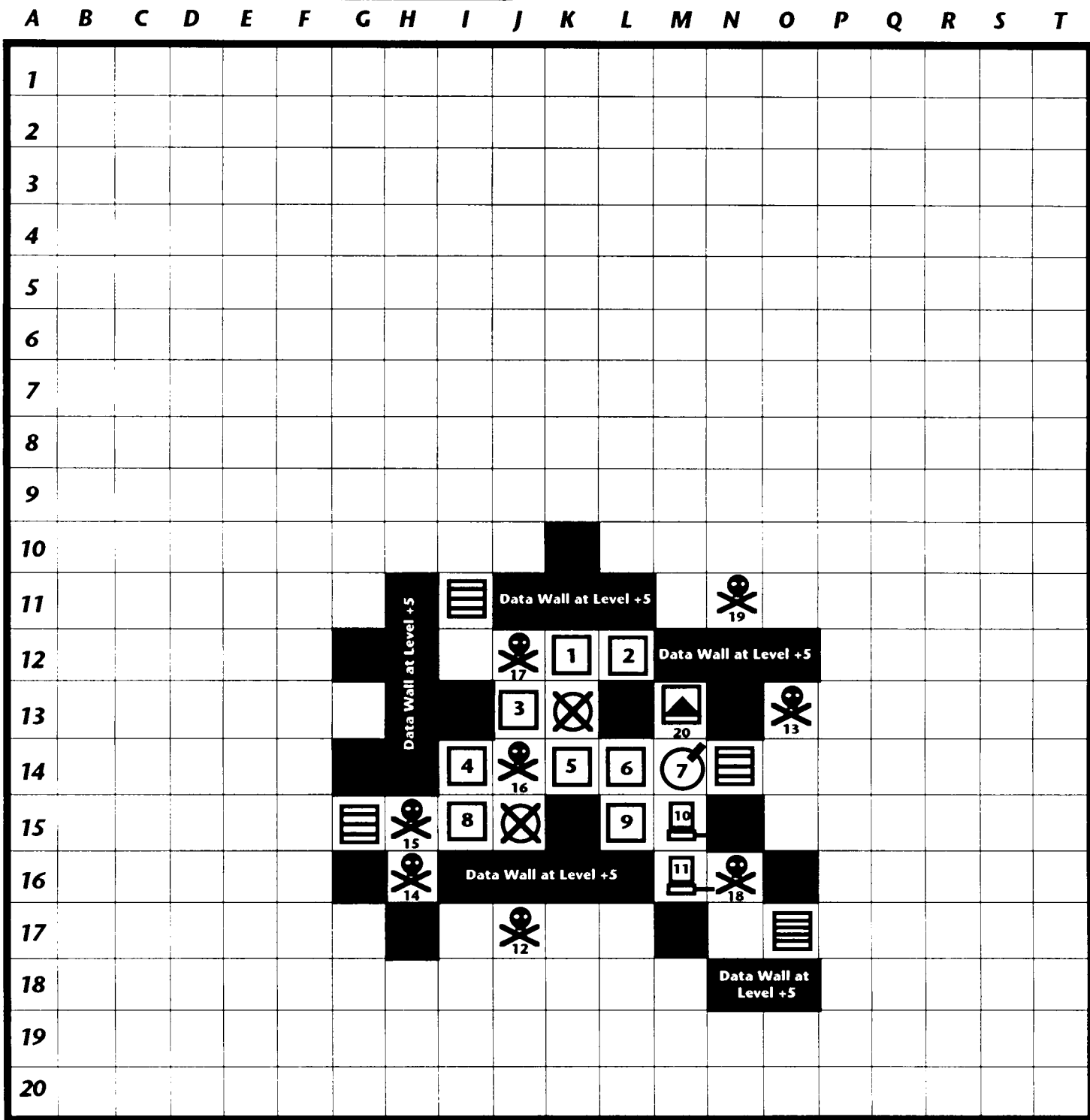

## SAMPLE SUBGRID MAP

**SYSTEM NAME** Militech Group (Wash.)    **Number of CPU** 2    **Total Cost** 41,440eb  
**INT** 6 + **10 Interface**    **DATA WALL STR** +5    **AI?** Yes  
**AI PERSONALITY?**     Friendly     Hostile     Stable     Intellectual     Machinelike     Remote  
**AI REACTION?**     Neutral     Kill     Observe     Report     Talk  
**AI ICON?**     Human     Geometric     Mythological     Voice     Technic     Humanoid

**SAMPLE SYSTEM INFORMATION (PAGE 2)**

<b>Number</b>	<b>Information</b>	<b>MU</b>
1	Financial Transactions	2
2	Database (Employee records), Business records (Pay records)	2
3	Virtual Conference Area (Fractal)	3
4	Business Records (Procurement), Grey Ops (Bribes)	3
5	Black Ops (Assassinations), Black Ops (Secret weapons under development)	2
6	Black Ops (Bribes to U.S. Congressmen)	1
7	Microphone in Executive Washroom	none
8	Interoffice Memos, Database (Customers)	2
9	Virtual Rec Area (Fractal Tropical Resort)	12
10	Terminal (Secretarial Area)	none
11	Terminal (Executive Offices)	none
12	Watchdog	5
13	Watchdog	5
14	Poison Flatline	2
15	Flatline	2
16	Hellhound	6
17	Brainwipe	4
18	Murphy	2
19	Watchdog	2
20	LDL to Militech's Los Angeles Metroplex Research Station's System	none
21	Note: Data Wall is Level 5. There is only one level to this system,	
22	which looks like a Militech Logo on it's side.Excess VR MU is stored in	
23	adjacent Memory Blocks.	
24		
25		
26		
27		
28		
29		
30		
31		
32		
33		
34		
35		
36		
37		
38		
39		
40		
41		
42		
43		
44		
45		
46		
47		
48		
49		
50		

**SYSTEM INFORMATION • BLANK PAGE**



**A B C D E F G H I J K L M N O P Q R S T**

1																			
2																			
3																			
4																			
5																			
6																			
7																			
8																			
9																			
10																			
11																			
12																			
13																			
14																			
15																			
16																			
17																			
18																			
19																			
20																			



**SUBGRID MAP**



**SYSTEM NAME** \_\_\_\_\_ **Number of CPU** \_\_\_\_\_ **Total Cost** \_\_\_\_\_

**INT** \_\_\_\_\_ **+ 10 Interface**

**DATA WALL STR** \_\_\_\_\_

**AI?** \_\_\_\_\_

**AI PERSONALITY ?**

- Friendly     Hostile     Stable     Intellectual     Machinelike     Remote

**AI REACTION?**

- Neutral     Kill     Observe     Report     Talk

**AI ICON?**

- Human     Geometric     Mythological     Voice     Technician     Humanoid

**SYSTEM INFORMATION (BLANK PAGE 2)**

Number	Information	MU
1		
2		
3		
4		
5		
6		
7		
8		
9		
10		
11		
12		
13		
14		
15		
16		
17		
18		
19		
20		
21		
22		
23		
24		
25		
26		
27		
28		
29		
30		
31		
32		
33		
34		
35		
36		
37		
38		
39		
40		
41		
42		
43		
44		
45		
46		
47		
48		
49		
50		

**Contextual:** Like a very good CD-ROM video game. Textures, colors, better sound.

**Fractal:** Like true computer animation. Full color, sound.

**Photorealistic:** about as real as being in a video.

**Superrealistic:** Just like real life.

To determine the effect of realism on your virtual's cost, multiply the base MU cost and the base dollar cost by the realism value below.

Type	Multiplier
Simple .....	x1
Contextural .....	x2
Fractal .....	x3
Photorealistic .....	x4
Superrealistic .....	x5

*Example: I build a virtual rec-area (Cost 4 MU and 100,000eb). I decide to make it as real as possible (x5). My total MU cost is 20, and my eb cost is 500,000.*

Decide what virtuals your system has and in what memories you will place them.

### Defenses

These are the programs that are used to keep the Netrunners from sneaking in and messing with your nice new system. **You may select any program from the master list on pg. 142 (if you pay for it).**

A program can be placed anywhere in the system (inside a memory, CPU, a blank space, etc.) However, you must subtract its MU cost from one of your memories.

Most programs are stationary; once you place them in the system, they stay there. However, *Hellhounds*, *Killers* and *Demons* are all mobile, and can patrol up to 1 square outside the data walls of their resident systems.

### Remotes

These are devices in Realspace attached to the computer system; manipulators for moving things, auto factories for construct-

ing things, remote controlled vehicles and robots, monitor cameras, hidden microphones, video display boards, printers, holographic displays, automatic gates & doors, elevators, voice boxes, alarm systems, terminals, etc. Each one is controlled by the computer, using the most appropriate skill for it's function, or, as in the case of videoboards, cameras, microphones, printers and holographics, simply used by the computer to gather and disseminate information.

### Remotes

**Terminals:** a terminal is basically a keyboard and a videoscreen, used to input information to the computer and get results back. Each CPU comes with one terminal; additional ones cost 5,000eb.

### Autofactories:

lathes and computer controlled assembly robots. Usually used in industrial plants, although there are many small fabrication shops on the Street that use this technology.

### Gates & Doors:

computer controlled gates.

Comon'; haven't you seen *Max Headroom* yet? And you call yourself a *Cyberpunk*!

**Elevators:** 'Nuff said.

**Holo Display:** emits a 3 dimensional image from a wall or floor port. Good for meetings; often part of an executive conference room.

**Manipulators:** required for repairing tasks, painting, or doing any other sort of "hand" work.

**Microphones:** common in a paranoid age.

**Printers:** Laser printers for hardcopy.

**TV Cameras:** also a common security measure. Usually in the halls of most corporate buildings (60%).

**Vehicles & robots:** small house cleaner'droids, taxis, corporate vehicles and limos (for execs without human drivers).

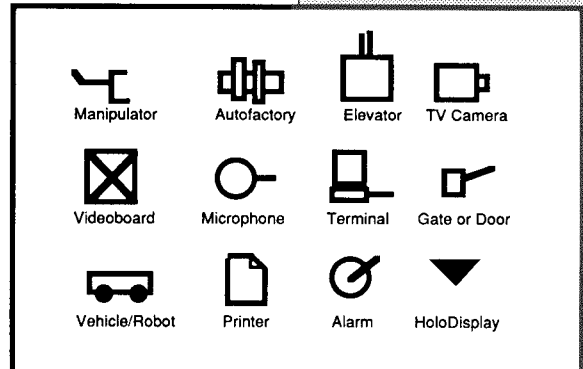



**Videoboard:** a large, flat-screen high-definition TV. Up to 60 meters long. A common type of billboard in 2020.

Decide what remotes your computer has and place a symbol for each one inside your computer map.

## Fast Fortress Construction System

You know they're gonna do it; sooner or later, your Cyberpunks are gonna blast right past the system you carefully constructed to waste them, and take some side trip to the outback of the Net. "What do we find there?" they'll say, as you look at your notes and groan.

No problem. We gotcha covered. With a few fast rolls (and a judicious use of common sense; a system filled with office gossip files and ten Hellhounds is pretty bogus), you can be ready to tackle even the most wayward group.

1) **Roll 1D6 to determine number of CPUs.** Remember; for each CPU, the system's INT increases by 3. Also, for every CPU, gain four spaces of memory, one Code Gate and one terminal.

**Note:** If the INT of your system is 12 or greater, your system is an **Artificial Intelligence (AI)**. To determine your AI's personality, roll 1D6 for each of the following tables:

### Personality

- 1 Friendly, curious
- 2 Hostile, paranoid
- 3 Stable, intelligent, businesslike
- 4 Intellectual, detached
- 5 Machinelike
- 6 Remote and godlike

### Reaction to netrunner

- 1-2 Neutral
- 3 Kill all intruders
- 4 Observe intruders, then act
- 5 Report all intruders
- 6 Talk to intruder to find intent

### ICON

- 1 Human
- 2 Geometric
- 3 Mythological
- 4 Voice only
- 5 Technic
- 6 "Humanoid"

2) **Determine Data Wall Strength.** Strength is equal to 1D6/2 plus the number of CPU in the system (round down). Example: LTRA 1500 has three CPU. 1 roll a 4. LTRA's Data Walls are Strength 2+3=5.

3) **Determine Code Gate Strength** by rolling 1D6/2 + number of CPU for each one.

4) **Pick 5 skills.** Roll 1D6+4 for level of skill in each one.

5) **Roll for types of files.** For each memory, roll 2 times for type:

- 1 Inter Office
- 2 Database
- 3 Business Records
- 4 Financial Transactions
- 5 Grey Ops
- 6 Black Ops

Place each file in a memory of your choice.

6) **Virtuals.** Roll 1D6. On a 5 or 6, there is a virtual reality present. Roll another D6 for type:

- 1 Virtual Conference
- 2 Virtual Office
- 3 Virtual Rec-Area
- 4 Virtual Building
- 5 Virtual City
- 6 Virtual World

**Roll 1D6 for level of realism:**

- 1-2 Simple
- 3 Contextual
- 4 Fractal
- 5 Photorealistic
- 6 Superrealistic

7) **Determine Defenses.** Roll 1D6+ number of CPU for total defenses. For each one, roll 1D10 for type, then 1D6 for subtype:

- 1-4 **Detection/Alarm**
  - 1-2 . Watchdog
  - 3-4 . Bloodhound
  - 5-6 . Pitbull

- 5-6 **Anti-IC**
  - 1-2 .Killer (roll 1D6 for Str.)
  - 3-4 .Manticore
  - 5-6 .Aardvark
- 7-8 **Anti-System**
  - 1 ..... Flatline
  - 2 ..... Poison Flatline
  - 3 ..... Krash
  - 4 ..... Viral 15
  - 5 ..... DecKrash
  - 6 ..... Murphy
- 9-10 **Anti-Personnel**
  - 1 ..... Stun
  - 2 ..... Hellbolt
  - 3 ..... Brainwipe
  - 4 ..... Knockout
  - 5 ..... Zombie
  - 6 ..... Hellhound

8) Roll 1D6 for number of remotes. For each remote, roll 1D10 for type:

- 1 Microphone
- 2 TV camera
- 3 Extra Terminal
- 4 Videoboard
- 5 Printer
- 6 Alarm
- 7 Remote vehicle or robot
- 8 Automatic door, gate
- 9 Elevator
- 10 Manipulator or Autofactory

9) Pick any one of the 6 possible layouts of data walls below or create your own. Plug your parts and programs into place and get ready to rock!

### HOT TIP

Ever notice how much subgrids resemble crossword puzzles? It's no accident— we planned it that way. A quick trip to the supermarket checkout line can provide you with endless hours of Netrunning fun. And you can grab the latest screamsheets (*World News*, *National Enquirer*) while you're at it!

### SAMPLE FORTRESS LAYOUTS

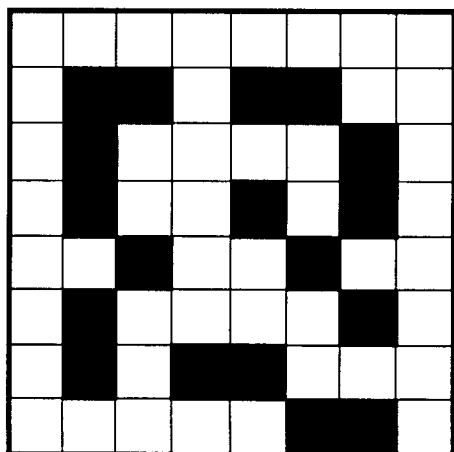

**ROLL 1**

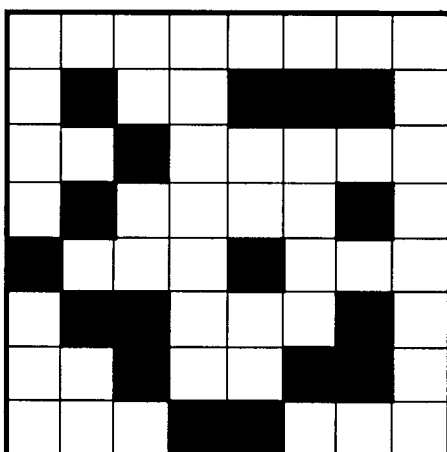

**ROLL 2**

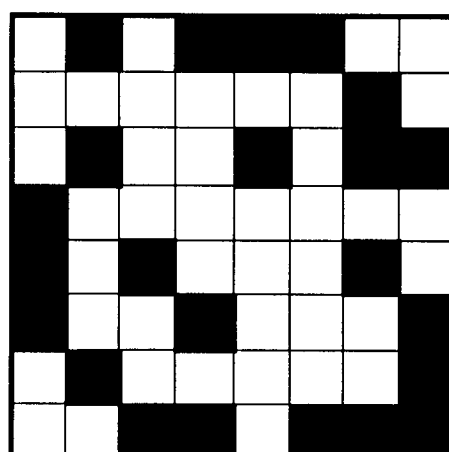

**ROLL 3**

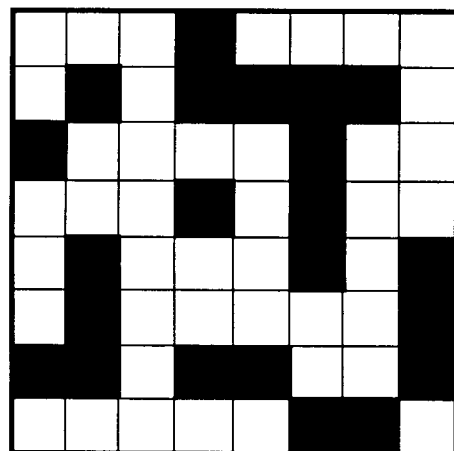

**ROLL 4**

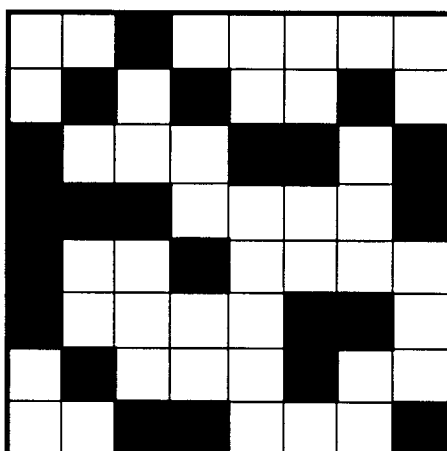

**ROLL 5**

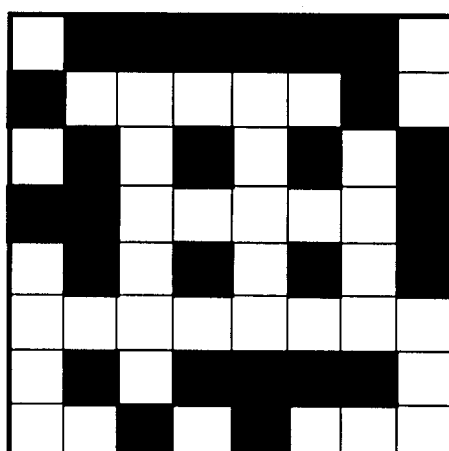

**ROLL 6**

## FAST SYSTEM

Name \_\_\_\_\_ # of CPU \_\_\_\_\_ Total Cost \_\_\_\_\_

INT \_\_\_\_\_ + 10 Interface DATA WALL STR \_\_\_\_\_

AI? \_\_\_\_\_ CODE GATE STR \_\_\_\_\_

### PERSONALITY ?

Friendly  Hostile  Stable  Intellectual

Machinelike  Remote

### REACTION?

Neutral  Kill  Observe  Report  Talk

### ICON

Human  Geometric  Mythological  Voice

Technic  Humanoid

### SKILLS

- 1 \_\_\_\_\_
- 2 \_\_\_\_\_
- 3 \_\_\_\_\_
- 4 \_\_\_\_\_
- 5 \_\_\_\_\_

### REMOTES

- 1 \_\_\_\_\_
- 2 \_\_\_\_\_
- 3 \_\_\_\_\_
- 4 \_\_\_\_\_
- 5 \_\_\_\_\_

### FILES, VIRTUALS, ETC.

- 1 \_\_\_\_\_
- 2 \_\_\_\_\_
- 3 \_\_\_\_\_
- 4 \_\_\_\_\_
- 5 \_\_\_\_\_
- 6 \_\_\_\_\_
- 7 \_\_\_\_\_
- 8 \_\_\_\_\_
- 9 \_\_\_\_\_
- 10 \_\_\_\_\_
- 11 \_\_\_\_\_
- 12 \_\_\_\_\_

### DEFENSES

- 1 \_\_\_\_\_
- 2 \_\_\_\_\_
- 3 \_\_\_\_\_
- 4 \_\_\_\_\_
- 5 \_\_\_\_\_
- 6 \_\_\_\_\_
- 7 \_\_\_\_\_
- 8 \_\_\_\_\_
- 9 \_\_\_\_\_
- 10 \_\_\_\_\_

## FAST SYSTEM

Name \_\_\_\_\_ # of CPU \_\_\_\_\_ Total Cost \_\_\_\_\_

INT \_\_\_\_\_ + 10 Interface DATA WALL STR \_\_\_\_\_

AI? \_\_\_\_\_ CODE GATE STR \_\_\_\_\_

### PERSONALITY ?

Friendly  Hostile  Stable  Intellectual

Machinelike  Remote

### REACTION?

Neutral  Kill  Observe  Report  Talk

### ICON

Human  Geometric  Mythological  Voice

Technic  Humanoid

### SKILLS

- 1 \_\_\_\_\_
- 2 \_\_\_\_\_
- 3 \_\_\_\_\_
- 4 \_\_\_\_\_
- 5 \_\_\_\_\_

### REMOTES

- 1 \_\_\_\_\_
- 2 \_\_\_\_\_
- 3 \_\_\_\_\_
- 4 \_\_\_\_\_
- 5 \_\_\_\_\_

### FILES, VIRTUALS, ETC.

- 1 \_\_\_\_\_
- 2 \_\_\_\_\_
- 3 \_\_\_\_\_
- 4 \_\_\_\_\_
- 5 \_\_\_\_\_
- 6 \_\_\_\_\_
- 7 \_\_\_\_\_
- 8 \_\_\_\_\_
- 9 \_\_\_\_\_
- 10 \_\_\_\_\_
- 11 \_\_\_\_\_
- 12 \_\_\_\_\_

### DEFENSES

- 1 \_\_\_\_\_
- 2 \_\_\_\_\_
- 3 \_\_\_\_\_
- 4 \_\_\_\_\_
- 5 \_\_\_\_\_
- 6 \_\_\_\_\_
- 7 \_\_\_\_\_
- 8 \_\_\_\_\_
- 9 \_\_\_\_\_
- 10 \_\_\_\_\_



## PROGRAMMING 101

### Creating New Software for Netrunning

Although you've got a lot of programs to choose from, it won't take long before you'll want to design your own. Home-grown programs can be the edge your Netrunner needs; because the old stuff gets known pretty fast around the Net.

### CONSTRUCTING NEW PROGRAMS

Every program is made up of three parts; **functions, options and strengths**. When you put functions, options and strengths together, you create a new program.

#### Functions

Functions are what the program *does*. Every program has a function.

You can often combine several functions into one program, making it more versatile and powerful.

DIFF	Type
10	<b>Evasion:</b> this function makes a program or the runner hard to trace
15	<b>Stealth:</b> this function makes the program or runner hard to detect
20	<b>Anti Program:</b> this function attacks and destroys other programs.
15	<b>Anti System:</b> this function damages or screws up a computer system.
10	<b>Detection:</b> this function detects intruding netrunners/programs
15	<b>Alarm:</b> this function alerts the system or Netrunner to intrusion
20	<b>Anti-Personnel:</b> this function attacks and kills Netrunners. The Netrunner is either killed (takes damage), taken over or mind wiped.
15	<b>Intrusion:</b> this function allows programs/netrunners to get through data walls.
10	<b>Protection:</b> this function stops attacks to netrunners or decks
15	<b>Decryption:</b> this function opens codes and locks
10	<b>Controller:</b> this function allows control of machines in Realspace.
10	<b>Utility:</b> this function restores damaged programs, copies things, improves deck speeds, reads files and does general librarian work.
10	<b>Interactive:</b> this program acts like a person in a virtual reality; it walks, moves around, manipulates objects in the virtual construct. When combined with pseudo-intellect and conversational ability, it can act much like a real person inside a virtual reality.
10	<b>Compiler (Demon):</b> This program manages other programs, and can reduce them in size by packing them tighter until needed.

The functions list above is designed to be general; the netrunner decides what his program is supposed to do, finds the function closest to his conception, and pays the Difficulty price for the function. How that function actually works is pretty much up to him and the Referee of the individual game; if your Anti-Personnel program kills a Netrunner by encasing his ICON in violet light and melts his brains with a burst of energy, that's great. But in game terms, it simply kills the netrunner.

Because functions leave a lot of leeway for imaginative thought, the Referee should always have the final word on whether a program really fits into that particular function or not. He or she may also want to raise or lower the Difficulty by a few points if the program stretches the boundaries of the

*"Me, I only trust  
what I write.  
And I write  
good stuff."  
—Edger*

listed functions a bit too much. And hey, if it gets out of hand, feel free to have the sucker backfire and eat the player's face. It's the *Cyberpunk* way.

### Options

Options are things that individualize a program. They allow it to move freely around the Net, to remember events, to recognize things, even obey commands and converse. You may want to create (with your Referee's approval), your own options as well.

**A Note on ICON:** ICONS are the visual representation of a program in the Net. An ICON can look like anything you want; people, monsters, objects, logos— you name it. Programs don't come with ICONS; they must be created for them. Not having an ICON doesn't mean the program can't be detected, but it does mean that it will just appear as an indistinct shape rather than a fully realized image.

#### DIFF Option

- 5 Movement ability: The program can move freely throughout the Net while it's main programming remains in memory.
- 2 Trace: the program can follow another program or netrunner through the Net.
- 3 Auto Re-Rez: the program can reconstruct itself even if destroyed by rolling a 5 or 6 on 1D6.
- 2 Recognition: the program can distinguish between different netrunner signals and programs.
- 3 Invisibility: the program is +2 Strength to evade detection.
- 5 Memory: the program can remember specific events and people.
- 2 Speed: the program adds +2 to deck speed when it runs.
- 3 Endurance: the program is tireless and will never quit unless destroyed.
- 3 Conversational ability: the program can speak.
- 6 Pseudo-intellect: the program can think like a real person of INT 6.
- 1 ICON (simple): the program has a visible, cartoon icon in the Net.
- 2 ICON (contextural): the program has a Net ICON about the graphic level of a high-res computer image.

- 3 ICON (fractal): the program has some what realistic Net ICON, with shading, texture and sensation.
- 4 ICON (photorealistic): the program has a very realistic ICON about the level of a good video image or movie.
- 5 ICON (superrealistic): the program has an ICON that looks like a real person or object.

### Strength

Strength is the power of the program. The higher a program's Strength, the more capable it is of fulfilling its functions. Strength is rated from one to ten. Most programs are around three or four.

### WRITING THE PROGRAM

Once you've determined the functions, options and strength level of the program, you must determine how hard it will be to write it. Add together all the DIFFICULTY COSTS for all options, plus the level of Strength; the result is the Difficulty number for the program.

*For example, Hellhound consists of:*

<i>Antipersonnel</i> .....	+20
<i>Movement</i> .....	+5
<i>Trace</i> .....	+2
<i>Recognition</i> .....	+2
<i>Strength 6</i> .....	+6
<i>Icon (Superrealistic)</i> .....	+5

*The total Difficulty of writing Hellhound would be 40*

To make a skill check for this, you would add your INT+ Programming Skill+ 1D10 to get a value equal to or greater than this Difficulty number.

**Pooling:** Sometimes, you won't have enough Skills to write a program. However, two or more netrunners can pool their respective INTs and Skills together, rolling one D10 for the total. *Example: With an INT of 8 and a Programming of 10, Spider can't possibly write a Difficulty 40 Hellhound. But with the help of Edger (INT 9, Programming 7), the two can mount an impressive total of 8+10+9+7=34. They'll need to roll a 6 on their D10 to successfully write the program.*

### HOW BIG IS THE PROGRAM?

Program size is determined by difficulty. Check the table below for the difficulty



number, then read across for the size in meg.

Difficulty	MU
10-15 .....	1
16-20 .....	2
21-25 .....	3
26-30 .....	4
31-35 .....	5
36-40 .....	6
41+ .....	7

*Hellhound has a Difficulty of 40; this means it will take 6 MU.*

**HOW LONG WILL IT TAKE TO WRITE?**

For every point of Difficulty involved in the program, it will take 6 hours of work. The work need not be continuous and it may be divided between netrunners if more than one is involved in the process. *For example, with a Diff of 40, it would take 240 hours of work to program Hellhound. Spider and the Edger decide to work in eight hour shifts; at this rate, they'll finish in about 30 days. However, they decide to work at the same time, cutting the time to only 15 days.*

**HOW MUCH WILL IT COST?**

Often, programs are purchased on the market rather than written at home. To determine the base cost of a program, multiply the Difficulty by 10eb. Multiply this value by the modifier below for the type of program.

Type	Modifier
Intrusion, Decryption Control, Utilities .....	1x Cost
Detection & Evasion .....	2x Cost
Anti System .....	3x Cost
Anti IC .....	4x Cost
Anti-Personnel .....	25x Cost

*Example: Hellhound's Difficulty is 40; at 10eb per point, it would cost about 400 euro. But as an anti-personnel program, it is multiplied by 25; it will cost 10,000eb on the black market!*

**DEMONOLOGY**

*Demons* are basically a specialized program designed to manage several other programs. These subprograms are compacted by the *Demon's* compiler function so that they take up half the space they would normally need, allowing the Ne-

trunner to carry more programs in the same amount of memory.

To build a *Demon*, you'll start by building a normal program, using the Compiler/*Demon* function. To this, you can add as many options as desired, as well as setting its Strength. The Strength of the *Demon* is somewhat modified by the number of programs it carries; for each program "on board", the *Demon* will lose one point of Strength. Example: *Succubus II* starts with a Strength of 7. But by carrying 3 programs, this Strength is reduced to 4.

Next, build all of your subprograms. Don't worry about their strengths; they'll fight at the strength level of the *Demon*, not their own. Now, after you've created them, add all Difficulty numbers together and divide by 2. Add this result to the Difficulty of the *Demon* and you have the total Difficulty (and the amount of memory required) for your completed *Demon*.

*Example: Edger builds a Demon to hold four programs. Nicknamed Pixie, the program is constructed like this:*

Compiler ( <i>Demon</i> ) .....	10
Icon ( <i>Simple</i> ) .....	1
Strength 7 .....	7
TOTAL .....	18

He then plugs in four programs, one at 30, one at 25, and two at 15 for a total of 70 Difficulty. But thanks to the *Demon*, the cost is only 35 points! The result is a final version of *Pixie* that has a value of only 53 points, a savings of 17 points.

A *Demon* sounds like a great idea at first; you get a lot of programs in a small space. But there are a couple of serious gliches:

First, the *Demon* is only able to control all these programs by linking it's programming with theirs. This means that whenever the *Demon* is destroyed, all the programs linked to it are also destroyed (sort of like a ship going down with all hands).

Second, all the programs fight at the same Strength level as the original *Demon*. Not a bad idea; load the *Demon* up with some

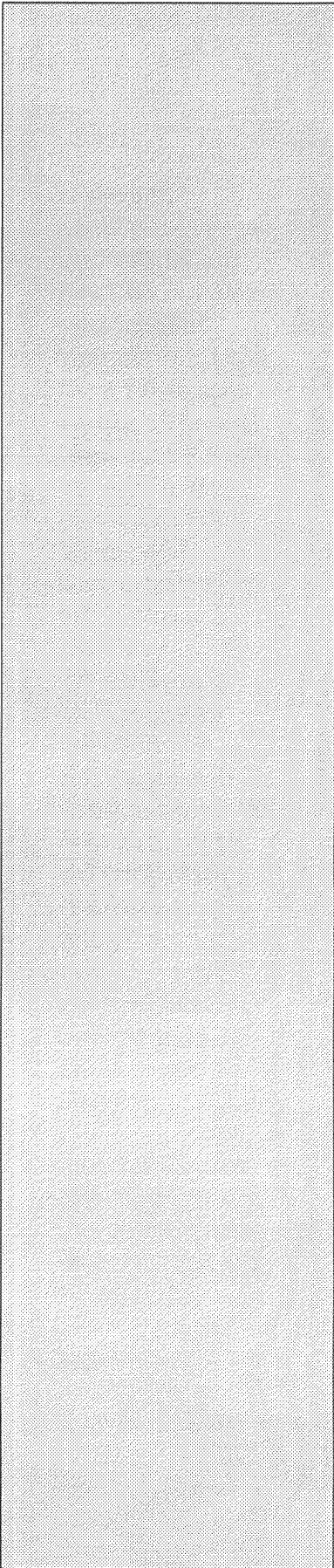

*"There's a cyberpsycho on the Night City LDL we call the 'Batguy'; an old EBM 'runner who went over the edge about seven years ago.*

*At night, he dresses up in this weird costume and crawls the rooftops looking for 'evildoers' to fight. When morning rolls in, he goes back to his flat and jacks into his own custom-designed 'Stately Jones Manor' reality and throws these huge parties.*

*"We'd shut him down, but hey, the parties are just too good to miss..."*

—Edger

cheap programs and if the *Demon's* Strength is high, they'll all fight like...well...demons. However, you won't have a very powerful *Demon* if you load up on a lot of subprograms.

Third, the *Demon* has to unpack each program before using it, then repack it when it's done. This means that there's a delay in Speed; a negative value equal to the number of programs currently loaded. For example, if you've got four programs loaded in a *Demon*, this will mean a corresponding -4 penalty to your deck Speed. When you have to get off the mark, this can be a disaster.

But if you're looking for a way to stash a lot of programming in a small space, a *Demon* is the way to go.

## VIRTUALLY THERE

### Artificial Realities in Netrunning

#### IN THE BEGINNING, THERE WAS CREATOR...

CREATOR, developed by Silicon Graphic Technologies in 2014, is a combination animation/drawing program which pulls objects from a huge database and tailors them to the designer's preferences. The object is then animated based on the overall background and the new objects relationship to the Netrunner and other objects in the memory area. *Creator* was originally designed as a demonstration program for Silicon's LYREX 3000 cybermodem. However, it was so popular that it was integrated directly into the operating system of the LYREX and all other subsequent SG decks. *Creator* was soon copied in various forms by other cyberdeck corporations, so that by 2016, it was standard operating equipment on 98% of all modern decks.

*Creator*, of course, is just perfect for generating Virtual Realities.

### Virtual Real Estate

A Virtual reality is just that; an artificial reality constructed via a combination of

sense stim and graphic imagery. It's like a pocket universe, often covering entire buildings, cities or even worlds. Virtual realities are the crowning achievement of interface technology in the 21st century.

### How Big are They?

The extent of a virtual reality is based on two things. The first is how much is actually in the reality, or the number of objects contained in it, to be exact. Size doesn't really have much to do with the number of objects containable in a reality; a tiny figurine, for example, is far more complex than a huge box, and will take up far more memory to create.

To simplify this, we simply count the total number of objects existing in the reality, averaging the levels of complexity over all the objects within. The result gives us a pretty good thumbnail for how much memory (in MU) will be required to create a given reality.

The actual space covered by the reality doesn't matter; you could build a huge virtual reality with only a hundred or so items, if one of them is an endless sky and the other is miles of empty grassland. What's important to the design is the number of separate objects that must be interacted with inside the reality.

This can lead to some interesting shortcuts. Want to build a huge mansion but don't have the MU for it? Build it as a 1,000 object reality, and make your vast shelves of books in the Library all one object (sure, you won't be able to pick up and read an individual book, but you don't often climb up there anyway). Make all of the walls as single objects; you won't be able to open windows or move pictures, but they'll look nice. And so on.

How much can be contained in a reality is

**"Creator? It's sort of like a Build-A-Universe Kit in a box. Sorta Godlike, yeah?"**  
—Spider Murphy

pretty much up to the Referee; he's the one who is best able to judge how much you will be able to interact with in a "game" context, after all (besides, he'll be the one who describes your virtual reality to you as part of the game). The descriptions in the table below are primarily there for reference; your Referee may decide that an aircraft carrier with a squadron of F-18s will

textures, tastes and sounds. They can pass through each other, around each other, and throw shadows.

Here's an example. There are a lot of ways to create a car. You can draw it as a box with a smaller box on top and four doughnuts for wheels. You can sketch it realistically, with the color, curves and reflections

@ Number of Objects	Description	MU
100 objects .....	Virtual Conference room	1
1000 objects .....	Complex Conference, or Office	2
10,000 objects .....	Complex Office or Virtual Rec Area	4
100,000 objects .....	Virtual Building	8
1,000,000 objects .....	Complex Building or Virtual City	16
1,000,000,000 objects .....	Complex City or Virtual World	32

only require 10,000 objects, just as long as most of the jets are simple, non-flying shapes, and that the only places you actually ever go to are your cabin, the flight deck and the bridge. Or he may decide that if you want a fully functional office, it will require 10,000 objects just to cover every piece of paper, individual pencil, or paperclip.

**Creating Individual Objects**

The creation of individual objects is also possible; it's just a pain in the neck when you have to make an entire universe. After all, do you really want to visualize every single leaf on every tree in a forest?

However, you may occasionally want to create a single item for a specific reason; a book you want to read or a meal you want to "eat. As a general rule, it takes about .01 MU to create any simple object. About .02 MU would create a fully functional object of reasonable complexity. As with the creation of larger realities, exactly how much memory is required to create a single object is up to the Referee.

**REALITY LEVEL**

The second component of a virtual reality is the level of its realism. The greater the realism, the more objects within the reality relate in ways you expect. Things in the reality have color, shadow, reflections,

a real car would have. You can paint it in the superrealistic style of a modern artist, so real that the chrome seems to shine. You can take a photograph of a real car. Or you can build a real car.

Each one of these steps represents an increase in the realism of the car. As you go up the scale, the car gets more real all the time. Reflections and shadow, texture, tastes, sounds and weights can all exist at varying levels of realism in a virtual reality. All it takes is the right program and enough memory to implement it.

*Creator* is that program. Using a huge database of digital braindance recordings and three dimensional reality modeling routines, *Creator* sets the level of realism for the entire construct, choosing and creating images from the database. As part of the reality's ground rules, all objects contained with the reality will be of the same level of realism throughout. *Creator* has five levels of realism:

**Simple:** The object is like a cartoon. There are colors and blocky shapes, but no shading, texture or difference in tastes. All objects weigh the same, feel the same to the touch, make the same limited sounds ("bonk!" "beep!").

**Contextural:** The reality is like a very good

**SCIENCE MEETS GAME**

Some of you more math- oriented types are going to immediately (as Staff Editor Will "Mister Science" Moss pointed out when he read this section) realize that the number of objects in a virtual reality rises by an order of magnitude, while the MU required doesn't.

Here's the catch. Most of the objects in a large virtual reality are actually "repeaters"— things that are so much like other similar things that they don't require their own special codes to create them. Instead, they steal their construction formulas from something very similar (sort of like a GOSUB routine for you programming types). Each time you create an object of a particular class, you just use the subroutine to create it.

For example, in the *Arasaka Castle* reality, there are hundreds of guards; they just all look the same, with only minor variations (see the *Crowd*, pg. 163). In a Virtual City, all of the cars are pretty similar, just like all of the buildings, birds, trees, rocks, signs, telephone poles, etc.

This is how (in our game universe, at least) we get around the problem of MU size vs. object count. Of course, the main reason is that in a game context, to hold a billion object Virtual World would require at least 100,000 MU (reflecting true orders of magnitude), which would in turn require at least 10,000 MU. No one would ever have enough memory to build really interesting Virtual Realities, and the game would be a lot less fun as a result.

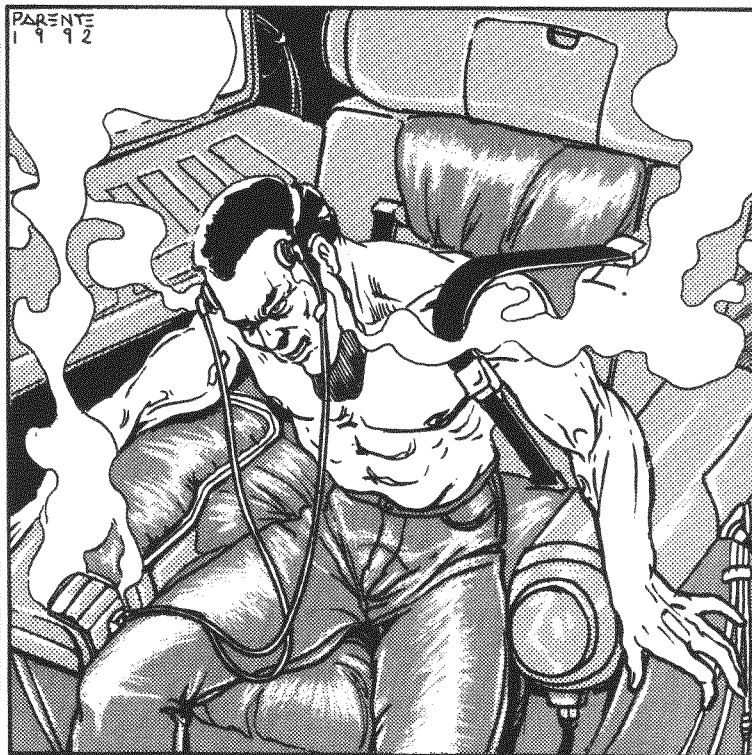

# FLATLINE

video game. There is color and shading. Textures are limited, but soft things feel soft, hard things hard, rough things rough and smooth things smooth. Tastes are sweet, sour, salty and acidic. Things make sounds that are much like they do in real life (a car engine sounds pretty much like a car, a bird like a bird), but lack definition as they are created from digital sound recordings.

**Fractal:** The reality is very much like real life. Each object has a distinct taste, sound and texture. Colors are blended smoothly, and objects are shiny, dull, transparent and opaque. There is hot and cold, but not fine degrees of temperature. Distance and the relationships of other objects have effects on each other; planes pass through clouds and the air gets misty, the sun reflects off water, etc.

**Photorealistic:** The reality is much like a very, very good movie. Tastes are very close to what they are in real life, as are textures, sounds and colors. Light reflects naturally off of objects. Things relate almost exactly like they do in actuality; waves move and reflect light in interesting patterns, trees blow in the wind, dust rises off the furniture, things are hot and cold relative to each other.

**Superrealistic:** If there's a difference between this and the real thing, you can't tell.

Multiply the MU cost of the virtual construct by the multiplier for the level of reality to determine it's final MU cost.

### REALISM MULTIPLIERS

Simple .....	x1
Contextural .....	x2
Fractal .....	x3
Photorealistic .....	x4
Superrealistic.....	x5

### Getting the Job Done

Creating a universe isn't an easy task; it takes the patience and imagination of a god to pull it off. To create a virtual reality, you must make a Skill check higher than the Difficulty number for that size of creation. This reflects your ability to interface with the Creator program and successfully direct it in the process of virtual reality construction.

1 object .....	automatic
100 objects .....	10
1,000 objects .....	15
10,000 objects.....	20
100,000 objects.....	25
1,000,000 objects.....	30
1,000,000,000 objects.....	35

Making it more or less real isn't a problem; *Creator* automatically sets the level of realism as desired and models it's constructs accordingly.

**Pooling:** Sometimes, you may not be able to create what you want at all; the task is just too big. However, two or more netrunners can pool their combined INT and *Interface Skills* and add a 1D10 roll to the total of this amount. They can divide the time for construction between themselves as well. This is how very large commercial virtuals are created; a team of netrunners splits the work up, with each one taking a specific part of the visualization task.

### How Long Will It Take?

Actually, a lot less time than you'd suspect. *Creator* works from the users' ability to visualize. It then generates an object from it's memory as closely as possible to the user's visualization. Objects are created at the speed of thought. As a rule:

1 object .....	1 second
100 objects .....	2 minutes
1,000 objects .....	15 minutes
10,000 objects .....	2 hours
100,000 objects .....	24 hours
1,000,000 objects .....	240 hours
1,000,000,000 objects .....	2,400 hours

### Spreading It All Out

You can spread out the memory cost of a virtual reality by placing it over adjacent memories. The actual load can be broken up into equal amounts and delegated to specific memories, or divided unequally with the overflow going into an empty memory. All memories used in a virtual reality must be adjacent to each other in the architecture of the system.

### Doing it in Sections

You can elect to start small when constructing a virtual reality; most humans can't possibly visualize every contingency of a billion object reality, and there isn't much point to building a billion object space if you can't fill it. The easiest way to do this is to do a small section first, then add another part of the reality adjacent to the first, until the entire memory is filled. You can then extend new sections to the next memory. The

*Arasaka Castle* reality in Osaka was constructed in this way; the upper management has a full team of programmers

### POPULATING YOUR REALITY

Okay, now you've made yourself a real nice place to play. Now it's time for some actors. Virtual realities are basically stage sets, with buildings, sky, trees and ground all serving as the major locations. Cars, AVs, books, furniture, etc., are all props in the virtual construct. But if you want other people to relate to, you need to create those separately, as programs. There are three kinds of "people" you can construct to populate a virtual reality:

**The Crowd:** The Crowd is an interactive program with limited conversational ability and a psuedo-intellect. The Crowd tends to act like...well...a crowd; all of it's members think and do about the same things. For example, if the Crowd is at a party, they will mill about, chatter aimlessly about nothing, and "ooh" and "ah" if you do something really interesting. However, if you attempt to engage a single member of the Crowd in conversation, he or she will only be able to utter banal pleasantries, like "Yeah, nice party" and "Hey, what about those (Giants, 49ers, Bears, Yankees, etc.)?". The Crowd doesn't have a Memory option, so if you meet someone from the Crowd elsewhere, he will stammer, try to pretend that he remembers you, and generally do all the things you would do in a similar situation. Who says this is an artificial reality?

To create a Crowd takes a Difficulty of 16 (multiplied by whatever you spend for it's level of realism). A Crowd takes up 1MU for every 100 people involved. The same crowd can be used in any part of the virtual reality; it just gets moved around and "re-dressed" for the next scene. Crowds are often sold on the open market or traded among Netrunners. After all, *everyone* needs a change from the same old Crowd.

**Individuals:** These are characters with all the psuedo-intellect and conversational abilities of the crowd, but with a memory option as well. They represent key players in your virtual reality, and can relate to you very much as real people would. They remember your name, what you've done together, and

**"I KNOW WHAT YOU WANT. AND I'M READY TO INTERFACE WITH YOU!"**

— *Virtual Vickie*

LDL 2543.9280

**"There's something really twisted about the idea of a virtual prostitution BBS."**

— *Spider Murphy*



**"Knew a guy once who created a virtual of his boss in the Microtech system. Every night, he'd cut it loose in a Night City simulation and hunt it down.**

**One evening, he was out on the Street when he saw his boss getting out of a taxi. The guy went completely off-line— it took four C-SWAT cops to pull him off the body...**

—Edger

even have their own personality quirks. Each Individual has a Difficulty of 21 (multiplied by whatever you spend for its level of realism), and takes up 2 MU of space. But this can be well worth it if the Individual is your own *Virtual Cute Blond Movie Starlet* (or *Hunk*).

Individual programs can often be bought or copied from other sources; there is a booming business in providing these one of a kind programs for virtual use. Most bulletin boards and shopping boards have advertising sections for Individual copies; these are known as "meat markets", "slave pits" and "casting couches". Prices range from a couple hundred eb (for the *Boring History Professor* model) to two or three thousand (for the *Zarkonian Love God/Goddess* model).

**Offensive/Defensive Programs:** Not all the "inhabitants" of a virtual reality are simple minded conversation pieces. Any offensive or defensive program can, for a few extra Difficulty points, be outfitted with an interactive option, conversational ability and pseudo-intellect. This allows the program to have a decorative function as well as a protective one; you can come home to your virtual castle, put your feet up in your virtual chair, have your virtual servant pour you a virtual drink and relax while petting your virtual (and deadly) Hellhound on it's shaggy metal head.

### A SAMPLE REALITY

The HUNT CLUB is a BBS established in the Olympia region of the Net; its realspace coordinates are probably somewhere outside of Denver (although no one knows for certain). The Hunt Club consists of a single 1,000,000 object (Complex Building) reality. The realism level is superrealistic, which raises the required memory space from the base 16 MU to 80MU. Due to the limitations of space, this virtual reality is stored in eight large adjacent memory spaces in the Hunt Club's data fortress.

The majority of the Club consists of the **Mansion**, which is contained in memories one and two. Most of the Mansion is made up of huge, English Tudor-style rooms filled with brickabrack and curios. These many rooms are quite simple; floors, carpets, drapes, panelled walls with non-removable

paintings. Only the furniture is mobile. Each room has a heavy oak door with a brass plate designating its function; most are used as conversation rooms for the many members of the BBS who visit here. It's a good place to exchange information, play games and otherwise socialize; it fills the position of the various areas of a standard bulletin board. Because the Mansion is limited to a few large objects, it uses very little actual memory.

Most of memory number three is taken up with the **Garden**; a reproduction of an English garden with roses, walks, a small reflecting pool and a croquet green. The edge of the Garden is bounded by a high hedge and the sky; the virtual reality stops here and going beyond this is impossible.

The **Drawing Room** occupies a large part of memories four and five, and is by far the most complex of the rooms, accessible only to Senior members of the Club. It contains the Hunt Club's extensive files (disguised as old books behind moving panels in the walls), a message board (designed to resemble a hotel cubbyhole box), and its entertainment, game and program library. This library is presided over by an alarm program known as **Dent**.

Dent contains functions for *Detection*, *Alarm* and interactive options, including the ability to remember events and people, recognize cybersignals, obey commands, conversational ability, pseudo-intelligence and constant activity. The Dent program is of Strength 6 and is a superrealistic ICON of a bored and somewhat nasal English butler.

In addition to Dent, the Drawing Room is also home to the DOG, a Strength 8 modified *Hellhound* program. The DOG is programmed to react to any alarm raised by Dent, whereupon it will attack the intruder.

The **Dining Room** occupies most of memories six and seven; it is a baroque hall with a vast table loaded with rare foods and wines. Because of the many individual dishes served, this room takes up a lot of object space; when additional memory is required elsewhere, parts of the Dining Room's banquet is de-rezzed by the Club SysOp to free up space.



**HISTORY  
TECHNOLOGY  
HOT TIPS  
NIGHT CITY  
MEGACORPS  
SCREAMSHEETS**

**SECTION**

**11**

**ALL  
THINGS  
DARK  
&  
CYBER  
PUNK**

# ***FUTURE SHOCK: History of An Alternate Time***

*In the United States, thirty-two years of corrupt government and economic destabilization have resulted in a nation divided— by class, by race and by economics.*

By the end of the 1980's, it was evident that the nation was in trouble. Most social norms had dissolved under an all engulfing wave of competing special interest groups, media fueled fads, and an overall "me first" worldview. By 1994, the number of homeless on the streets had skyrocketed to 21 million. The technical revolution had further torn the economy apart, creating two radically divergent classes—a wealthy, technically oriented, materially acquisitive group

of corporate professionals, and a down class of homeless, unskilled, blue-collar workers. The middle class was nearly eradicated. It was this dismal beginning that led to the current American landscape of the 2000s.

In large cities, business areas are clean, neat, well lit showcases, free of crime and poverty, controlled by powerful corporations. Ringing the central areas are the **Combat Zones**— decrepit, squalid suburbs and burned out ghettos teeming with booster-gangs and other violent sociopaths. The outer suburbs are also corporate-controlled zones; safe, well-guarded tracts where executives raise their families in relative security.

Throughout the **Midwestern states**, many small towns have been abandoned, as local farms, businesses and banks collapsed in the wake of drought, famine and economic chaos. The farms have been bought up by huge agrcorporations, and are maintained with hired workers, machine labor, and well-equipped guards. The open freeways are battlegrounds, as armed packs of Nomads travel from city to city, looting and pillaging like mechanized Visigoths.

In this bleak landscape is a bright light of hope. The upheavals of the last decade have unified the poor, oppressed and angry of the nation. There are signs that the gang mentality of

## **A FUTURE HISTORY TIMELINE**

### **1990**

START OF FIRST CENTRAL AMERICAN CONFLICT. U.S. ENGAGES IN INTERVENTIONIST ACTIONS IN PANAMA, NICARAGUA, HONDURAS, EL SALVADOR. MILITARY FORCES ARE SENT TO SECURE THE CANAL ZONE FROM AN EX-U.S. PUPPET DICTATOR.

WEST, EAST GERMANY REUNITED. WARSAW PACT BREAKS UP INTO SEPARATE NATIONS.

BREAKUP OF SOVIET MEGA-STATE. FROM THIS POINT, THE USSR BEGINS A NEW ERA OF REAPPROACHMENT WITH WESTERN EUROPE; BY THE 2000'S, THE SOVIETS ARE THE EUROTHEATRE'S MOST POWERFUL ALLIES.

SOVIET PRESIDENT GORBACHEV APPOINTS PARTY SUCESSOR, ANDREI GORBOREV

FALL OF SOUTH AFRICA. FOR THE NEXT 4 YEARS, THERE IS LITTLE OR NO COMMUNICATION, ALTHOUGH TERRIBLE ATROCITIES AND GENOCIDAL WARS ARE RUMORED.

### **1991**

EUROSPACE AGENCY LAUNCHES HERMES SPACEPLANE

GORBOREV REGIME PURGES LAST OF OLD HARDLINERS

CHOOH2 DEVELOPED BY BIOTECHNICA

FIRST ARCOLOGY BUILT ON RUINS OF JERSEY CITY. 16 "ARCOS" BEGIN CONSTRUCTION OVER THE NEXT 5 YEARS, UNTIL THE COLLAPSE OF 1997, LEAVING THE HUGE STRUCTURES HALF COMPLETED, FILLED WITH SQUATTERS AND HOMELESS.

ARTIFICIAL MUSCLE FIBERS DEVELOPED AT STANFORD RESEARCH CENTER.

### **1992**

THE TREATY OF 1992 ESTABLISHES THE EUROPEAN ECONOMIC COMMUNITY. ZONES OF CONTROL AND PROTECTIVE TARIFFS REGULATE THE ACTIVITIES OF MEMBER NATIONS, FRANCE, BRITAIN, UNITED GERMANY, ITALY. A COMMON CURRENCY UNIT (THE EURODOLLAR) IS ESTABLISHED, BASED ON AVERAGE VALUE IN GOLD OF ALL CURRENCIES COMBINED. TRAPPED IN PARANOID ISOLATIONISM, THE U.S. DECLINES TO ENTER.

THE U.S. DRUG ENFORCMENT AGENCY DEVELOPS AND SPREADS SEVERAL DESIGNER PLAGUES WORLDWIDE, TARGETING COCA AND OPIUM PLANTS

GOVERNMENTS OF CHILE, ECUADOR COLLAPSE.

A SAVAGE DRUG WAR BREAKS OUT BETWEEN EUROCORP-BACKED DEALERS AND DEA ALL OVER THE AMERICAS.

FIRST USE OF HIGH ENERGY LASER LIFT ARRAYS IN USSR. SIMPLE MASSDRIVER ESTABLISHED IN CANARY ISLANDS BY EIGHT MEMBER EUROSPACE AGENCY.

### **1993**

FIRST TRC BIOLOGIC INTERFACE CHIPS DEVELOPED IN MUNICH, UNITED GERMANY.

AV-4 AERODYNE ASSAULT VEHICLE DEVELOPED TO DEAL WITH INCREASING RIOTS IN U.S. URBAN ZONES.

COLUMBIAN DRUGLORDS DETONATE SMALL TACTICAL NUCLEAR DEVICE IN NEW YORK. 15,000 KILLED.

### **1994**

WORLD STOCK MARKET CRASH OF '94. U.S. ECONOMY TEETERS, THEN COLLAPSES.

NUCLEAR ACCIDENT IN PITTSBURGH KILLS 257. CANCER DEATHS SOAR OVER NEXT TEN YEARS.

### **1995**

KILAMANJARO MASSDRIVER BEGINS CONSTRUCTION, UNDER JOINT AGREEMENT BETWEEN ESA AND PAN AFRICAN ALLIANCE.

the early 2000's is giving way to a new movement, as Rockers, Nomads, Solos and Medias take to the streets to fight authority and oppression. Far from being finished, the United States seems to be, against all odds, coming back. But only time will tell if the so-called *Cyberpunk* revolution will succeed.

In the Eurotheatre, things are considerably better. The World Stock Exchange and the Common Market have created a stable, profitable economy in which most of the European nations participate—the exceptions are **Italy, Spain and Greece**—all of which suffer chronic political upheavals. Here, the international corporations also have a great deal of power, but various Euro-governments have skillfully managed to keep these business barons under control. Only **Great Britain** has suffered major economic trouble—swamped by massive immigration and an antiquated technological base,

its streets are almost as explosively dangerous as the United States'.

With the massive reforms of the early 1990's (and the subsequent purge of hardliners in 1991), the Neo-Soviet Union has emerged as a strong partner in the expanding Eurotheatre. Most of Eastern Europe now enjoys an autonomy unthinkable during the days of the Cold War. Where the Soviet State is weakest is in food production. It still cannot feed its hungry population, and its technology lags far behind most other nations in the Eurotheatre. With con-

tinuing failure of the revamped Neo Communist Party's economic and social reforms, the hardliners are once again gaining strength and a showdown between the surviving cold warriors and the liberal reformers is coming fast.

The Middle East is silent—ominously so. The Meltdown has left vast areas of Iran, Libya, Iraq, Chad and the Arab Emirates as radioactive fields of glass. Only Egypt, Syria and Israel survived intact; their aircraft were

able to down the incoming suicide bombers. The majority of regional peoples have been reduced to mob

***"Imagine a world where Central America didn't become a battleground; where the U.S. solved its problems of crime, inflation and drugs; where the Cold War ended in democracy, not a succession of squabbling dictatorships..."***  
**—Dr. Albert Harper**  
**author of *History in Collision*, 2015**

## 1996

**THE COLLAPSE OF THE UNITED STATES. WEAKENED BY LOSSES IN THE WORLD STOCK CRASH, OVERWHELMED BY UNEMPLOYMENT, HOMELESSNESS AND CORRUPTION, MANY CITY GOVERNMENTS COLLAPSE OR GO BANKRUPT. THE U.S. GOVERNMENT, SNARLED IN A STAGGERING DEFICIT AND THE MACHINATIONS OF THE GANG OF FOUR, IS TOTALLY INEFFECTIVE.**

**NOMAD RIOTS. BY NOW, 1 IN 4 AMERICANS ARE HOMELESS. HUNDREDS OF THOUSANDS RIOT FOR LIVING SPACE THROUGHOUT THE U.S., NOMAD PACKS SPRING UP ON THE WEST COAST AND SPREAD RAPIDLY THROUGH THE NATION.**

**FIRST APPEARANCE OF BOOSTERGANGS.**

**LAWYER PURGE. IRATE CITIZENS LYNCH HUNDREDS OF CRIMINAL DEFENSE ATTORNEYS.**

**CONSTITUTION SUSPENDED. MARTIAL LAW ESTABLISHED IN U.S.**

## 1997

**MIDEAST MELTDOWN. TENSIONS IN MIDDLE EAST ESCALATE TO NUCLEAR EXCHANGE. IRAN, IRAQ, LIBYA, CHAD AND THE ARAB EMIRATES REDUCED TO RADIOACTIVE SLAG. WORLD OIL SUPPLY DROPS BY HALF.**

**TOXIC SPILL KILLS OFF MOST OF SALMON POPULATION IN PACIFIC NORTHWEST. SEATTLE ECONOMY CRIPPLED.**

**'ROCKERBOY' MANSON KILLED IN ENGLAND.**

## 1998

**NEO-LUDDITES RE-ESTABLISHED IN WESTERN KENTUCKY. OVER THE NEXT TEN YEARS, THE "LUDS" ARE RESPONSIBLE FOR BOMBINGS OF AIRPORTS, FACTORIES, FREEWAYS AND MASS TRANSIT TERMINALS.**

**THE DROUGHT OF '98 REDUCES MOST OF THE MIDWEST TO PARCHED GRASSLANDS. BETWEEN AGRIBUSINESS CORPS AND DROUGHT, THE FAMILY FARM ALL BUT DISAPPEARS.**

**10.5 QUAKE SHATTERS LOS ANGELES, OCEAN INUNDATES 35% OF THE CITY. AN ESTIMATED 65,000 ARE KILLED.**

## 1999

**FEDERAL WEAPONS STATUTE ESTABLISHED.**

**MILLENNIUM CULTS BEGIN TO APPEAR, PREDICTING AN APOCALYPSE ON JAN 1, 2000. THOUSANDS MIGRATE TO ISOLATED COMMUNES AND TEMPLES TO "AWAIT THE END".**

**TYCHO COLONY ESTABLISHED. A MASSDRIVER IS CONSTRUCTED TO PROVIDE RAW MATERIALS FOR ORBITAL PLATFORMS.**

## 2000

**MILLENNIUM CULTS RUN AMOK ON JAN 1ST IN AN ORGY OF SUICIDE AND VIOLENCE, MOST DESTROY THEMSELVES.**

**FIRST "EXTENDED FAMILY" POSERGANGS ESTABLISHED.**

**MASSIVE FIRESTORMS RAGE OVER NORTHWESTERN U.S., DESTROYING MILLIONS OF ACRES OF FARM AND GRASSLAND.**

**CRYSTAL PALACE SPACE STATION BEGUN AT L-5.**

**WASTING PLAGUE HITS U.S., EUROPE, KILLING HUNDREDS OF THOUSANDS.**

## 2001

**THE FRAMEWORK OF THE NET IS NOW FIRMLY IN PLACE WITH CONSTRUCTION OF THE WORLDSAT NETWORK.**

## 2002

**FOOD CRASH; MUTATED PLANT VIRUS WIPES OUT CANADIAN, SOVIET CROPS. U.S. AGRIBUSINESS CROPS SURVIVE DUE TO NEW BIOLOGICAL COUNTERAGENT. USSR ACCUSES U.S. OF BIOLOGICAL WARFARE.**

rule, clustered in their blasted cities or cowering under the tyranny of a local warlord. Many have fled into the desert, to reappear as warrior-tribes. Others have embraced religious fanaticism, sweeping out of the ruined Mid-East to avenge themselves with acts of terrorism and murder. Rumors of jihad—the Holy War—are on the radioactive wind, although it is still unclear what form the coming war with the infidel will take this time.

### THE RISE OF THE EUROPEAN COMMUNITY.

*Forget the Pacific Century— this is the age of Neo-Europe. By the late 1980's, it became pretty obvious that the Europeans needed to put aside their old rivalries and ally against in increasingly competitive world. The European Economic Community was established to meet this need for new alliances.*

*Unfortunately, this didn't mean that the EEC had to cooperate with other nations outside of Europe. Japan, China, Korea and the US are not members of the EEC (Japan was kicked out in 2015), and have suffered heavily from protective European tariffs and unfair trade practices.*

From the bloodbaths of Capetown, New Africa emerged as a fractured continent of warring countries under a bewildering array of dictators,

democracies and socialist states. Eventually, as the Euro-nations negotiated with Tanzania to build the Kilimanjaro massdriver, many of the African nations began to see their place in the 21st century. Bargaining with manpower, raw materials, and valuable land on the critical Equatorial orbital belt, the African states established their footholds in space—nearly one third of all space construction workers are African, and the majority of spaceport facilities and construction areas are on African soil. Technology has joined Africa under one government, and the last petty dictators and tribalisms are falling fast before the lure of the stars.

In the Far East, Japan faces an age of new challenges. Out from the protective shadow of the United States, it must not only cope with its own defense in a nuclear age, but also rising

competition with Korea, China and the re-organized New Phillipines. In recent years, the Japanese have changed from economic rivals and robber barons to economic supporters of the U.S. economy. But old scars from the trade wars of the 1990s die hard, and true mutual cooperation between the U.S. and Japan is a long time coming. This is further aggravated by the fact that China, a newly emerging power in its own right, has further strengthened its relations with the U.S. through the Mutual Defense Treaty of 2009.

After a lengthy war with the United States, Central America has emerged as a strong union of independent states, working under a pact of mutual cooperation. The U.S. has been expelled from all but the Panama Canal Zone, which it holds by sheer military force against ongoing guerilla aggression. South America is a warzone of juntas, secret police, ex-drug lords and military oppression, torn by periodic combat and revolution.

## Legal Background

The police of the 2000's are organized much as they were during the 20th

### 2003

SECOND CENTRAL AMERICAN WAR. U.S. INVADES COLUMBIA, ECUADOR, PERU, VENEZUELA. THE WAR IS A DISASTER THAT COSTS THOUSANDS OF AMERICAN LIVES. EVENTUALLY, THE REMAINDER OF THE GANG OF FOUR IS SWEEPED AWAY ON A WAVE OF REFORM.

WNS MEDIA STAR TESLA JOHANNESON EXPOSES SECRET NSA TRANSCRIPTS OF THE FIRST CENTRAL AMERICAN CONFLICT.

### 2004

FIRST CLONED TISSUE GROWTH IN VITRO. MICROSUTURES, STERILIZER FIELDS DEVELOPED.

TESLA JOHANNESON ASSASSINATED IN CAIRO.

FIRST CORP WAR. 12 MULTINATS, (INCLUDING EBM & OA) BATTLE FOR CONTROL OF TRANS-WORLD AIR.

### 2005

CYBERMODEM INVENTED.

EBM SOLOS ATTACK TOKYO OFFICE OF KENJIRI TECHNOLOGIES, KILLING 18.

END OF 1ST CORP WAR.

### 2006

FIRST HUMAN CLONE GROWN IN VITRO. MINDLESS, IT ONLY LIVES FOR 6 HOURS.

### 2007

SECOND CORPORATE WAR: INVOLVING A NUMBER OF FIRMS INCLUDING PETROCHEM, THE DISPUTE IS OVER OILFIELDS IN THE SOUTH CHINA SEA.

BRAINANCE DEVELOPED AT UC SANTA CRUZ.

### 2008

US ASSAULT ON SOVIET WEAPONS PLATFORM MIR XIII. EUROSPACE AGENCY INTERVENES. AND ORBITAL WAR BREAKS OUT BETWEEN THE "EUROS" AND THE "YANKS", UNTIL TYCHO COLONY MASSDRIVER DROPS A ROCK ON COLORADO SPRINGS. AN UNEASY PEACE IS REACHED.

### 2009

JOINT EURO-SOVIET MISSION TO MARS DEPARTS.

CORPORATIONS ERADICATE MOB RULE IN NIGHT CITY.

ABORTIVE TAKEOVER ATTEMPT BY U.S. "TERRORIST GROUP" OF CRYSTAL PALACE CONSTRUCTION. ESA DISCOVERS DEFENCE INTELLIGENCE AGENCY PLOT AND DROPS 12 TON ROCK OFF WASHINGTON AS A WARNING.



century with Homicide, Vice, Burglary and Traffic Squads; about 5 men each. The most recent addition to police organization has been the addition of the Cyberpsycho Squad (also known as the Psycho Squad), whose main job is to deal with cybernetic criminals. While the average beat cop hits the Street in an armored squad car, wearing an armor jacket, helmet and carrying a smart-chipped Beretta sidearm, the Psycho Squad detail employs aerogyros, AV-4's, miniguns, assault weapons and Stinger missile launchers.

City cops can patrol all areas of the city. Corporate Cops are deputized to patrol only corporate facilities. However, in areas where a large number of office areas are side by side, this effectively can turn an entire downtown region into Corporate Cop territory. Corporate Cops are usually better armed and armored, and often have full Trauma Team medical coverage. They are also more vicious, sadistic and likely to shoot first—after all, they know the Corporation can cover the incident up.

### The Uniform Civilian Justice Code

Skyrocketing crime rates in the 1990's,

proved that the existing legal structure was falling apart. Following the Purge of 1996, (when citizen's groups lynched hundreds of criminal defense lawyers), the Government declared martial law throughout the U.S. for a period of three years. During this time, justice was dispensed by local military courts. The amazing thing is, it worked.

A death penalty for looting brings a wonderful element of stability to a rioting neighborhood.

During this period, the Military Justice Code was the main rule of U.S. law. Its draconian standards of crime and punishment served so well that when martial law was suspended in 1999,

**UNIFORM CIVILIAN JUSTICE CODE**  
**HERE ARE THE MAJOR CRIMES OF THE 2000'S AND THEIR PUNISHMENTS AS PROVIDED FOR UNDER THE UCJC:**  
**Assault & Battery:** Any unprovoked attack on another person. Punishable by personality adjustment or 1D6+1 months in jail.  
**Assault with Deadly Force:** As with Assault. 1D6+1 years in jail, mandatory braindance.  
**Burglary:** Entering private property with intent to steal. Punishment: Exile, prison (1D6+1 years) or braindance.  
**Conspiracy:** the crime of conspiring to commit a felony. Subject to Exile, prison (1D6+1 years) or braindance.  
**Counterfeiting & Forgery:** the crime of creating false coinage, money, or documents with intent to defraud. Punishment: prison (1D10+5 years).  
**Extortion or Blackmail:** the crime of obtaining something from another through threat of injury. Punishment: Prison (1D10+5 years).  
**Homicide (1st Degree):** Premeditated murder, or murder while in the commission of a felony. Punishment is death.  
**Homicide (2nd Degree):** Accidental murder, murder without premeditation. Punishment: Prison for 1D10+10 years, braindance, personality alteration.  
**Homicide (Justifiable):** Self defense, preventing the commission of a felony. No punishment.  
**Kidnapping or False Imprisonment:** To hold another against his will. Punishment: Prison for 1D10+10 years, braindance, personality alteration.  
**Larceny, Theft or Robbery:** The theft of another's property, either through force, threat, or embezzlement. Punishment varies by severity of act from exile, to prison for 1D10+10 years, braindance, personality alteration.  
**Malicious Mischief, Vandalism:** the wanton destruction of another's property. Punishment: Exile, jail for 1D6 months.  
**Rape:** Forcing another to have sex by use of threat or force. Punishment: Prison for 1D10+5 years, braindance, personality alteration.  
**Resisting Arrest/Obstructing an Officer:** Attempting to escape legal arrest by a police officer, or preventing an officer from carrying out his legal duties. Punishment: Exile, braindance, jail for 1D6+1 weeks.  
**Riot or Unlawful Assembly:** A gathering with the purpose of destroying property, inciting violence, etc. Punishment: exile, jail for 1D6+1 days.  
**Trespassing:** Entering private property of another. jail for 1D6 days.

## 2010

END OF SECOND CENTRAL AMERICAN CONFLICT.

NETWORK 54 NOW CONTROLS 62% OF ALL MEDIA BROADCASTING IN U.S.

FOOD RIOTS IN DENVER KILL 52.

## 2011

CRYSTAL PALACE IS COMPLETED. ESA NOW HAS A PERMANENT HOLD IN HIGH ORBIT ZONE.

ESA/SOVIET MISSION REACHES MARS.

## 2012

BIOPLAGUE KILLS 1,700 IN CHICAGO.

CONCERT RIOT IN NIGHT CITY KILLS 18, WOUNDS 51. OLD ARASAKA COMPLEX GUTTED.

## 2013

NETWATCH ESTABLISHED BY JOINT U.S./EUROTHEATRE TREATY.

FIRST TRUE ARTIFICIAL INTELLIGENCE DEVELOPED AT MICROTECH'S SUNNYVALE, CA. FACILITY.

## 2014

I-G TRANSFORMATIONS REDESIGN THE NET.

"METAL WARS" BEGIN IN NIGHT CITY AS GANGS BATTLE FOR TURF.

## 2015

RISE OF THE CYBER-MERCENARIES; LITHUANIA HIRES CYBER-SOLDIERS TO REPEL INVASIONS BY LATVIAN NATIONALS.

## 2016

THIRD CORPORATE WAR IS FOUGHT IN THE NET, AS RIVAL CORPS ATTACK EACH OTHER'S DATA FORTRESSES.

## 2017

FIRST SELF-AWARE HUMAN CLONES CREATED.

## 2018

BRUSHFIRE WARS ERUPT IN EASTERN EUROPE.

ESA MISSION LAUNCHED TO JUPITER

## 2019

ORBITAL COLONY REVOLT AT L-3.

## 2020

THE PRESENT.

the Government established a Uniform Civilian Justice Code in its place. Although the law is now administered by civilian governments, the Code is the guideline for all criminal procedure in the United States of 2020.

Plea bargaining (pleading guilty to a lesser charge to speed up a trial) has been eliminated. Probation is almost unheard of. The death penalty is standard for murder cases—there is a 3 month appeal process during which new evidence can be produced. Most felonies have mandatory prison terms of 5 to 10 years. Lesser crimes are covered by exile or personality adjustment.

Self defense is defined as “any instance in which the assailant can show just cause that his/her life, or the life of another party was threatened, in circumstances where a duly appointed officer of the law could not be summoned, or where it was impossible to restrain the injured party by any other means.

Theoretically, narcotics may not be possessed within the premises of the United States. However bioengineered plant diseases developed through the 1990’s by the Drug Enforcement Agency wiped out 96% of the coca and opium plants in existence, making the point moot. The law also does not cover “designer drugs” such as endorphins, which are defined as medicinal.

### Crime & Punishment

The punishment for criminal actions under the Uniform Justice Code of 1999 are swift, certain and draconian. The simplest is personality adjustment—a process which implants an aversion to committing the crime ever again. Adjustment has some nasty side effects, including exaggerated fears of situations and events related to the crime (such as a terror of money based on an anti-robbery adjustment).

Exile implants are keyed to a transmission signal broadcast thru the city

phone Net. If the offender enters the city, the implant causes excruciating pain. The offender is effectively exiled from ever entering that specific city again. Repeat offenses in other cities simply cause additional city codes to be added to the implant. After enough crimes in enough cities, the offender will be unable to enter civilization again.

Prisons of the 2000’s are horrendously overcrowded and deadly. After the riots of the 90’s, prison authorities couldn’t care less about rehabilitation—they are mostly interested in penning up society’s “mad dogs” and keeping the streets clear. To cope with overcrowding, many prisons force inmates into “braindance”—they are placed in cryo tanks, wired to interface loop programs, and “shut down” for periods of two or three years. Continuous braindance creates a nightmare of unending, bland horror, making it the thing cons fear most.

The simplest method of punishment is still execution. Most states have a State Executioner who administers justice with one well placed .44 slug at point blank range. He is also empowered to hunt down escapees from Death Row.

## Weapons

By 1997, even the most well-intentioned gun control statutes were buried under a wave of public protest as crime rates made America a siege state. Self-defense soon became an American lifestyle, and there was an explosive increase in light personal protection weapons.

By 1999, most gun control statutes involved 1) filling out a “carry application” allowing you to carry a concealed handgun; 2) waiting 4 days for an extensive background check and approval, which could be refused on the basis of a criminal record or history of mental illness; and 3) paying the \$25.00 fee and having a serial num-

ber laser etched into the butt of the gun. This number is cataloged with the ballistics firing pattern of your weapon at FBI/CIA Headquarters in Washington D.C.

**The Federal Weapons Statute of 1999** states that if a gun with your ID number is used in the commission of a crime, you are liable for that crime, unless you have previously reported the weapon as lost or stolen, and have had this report filed with your local police agency.

Under the provisions of the Federal Weapons Statute, it is not legal to carry submachineguns and other fully automatic weapons—possession carries a stiff 5 to 7 year mandatory prison sentence. Not that this stops anyone.

While there’s a certain style in using an old model sidearm like a Colt .357 or .45, the sensible cyberpunk knows that a modern pistol makes a good backup. Since the introduction of the Glock 17 automatic in the mid-1980’s, most major handgun manufacturers now produce polymer resin pistols in a variety of calibers.

The most ubiquitous of these is the Federated Arms X-22 and X-9 series, a line of polymer plastic handguns. Manufactured in a variety of bright, designer colors, these so-called “Polymer One-shots” carry an easy to load 10 or 8 round clips of caseless ammunition, retail at \$150 to \$300, and are available in most sporting goods stores. They combine practicality, durability and style in potent little packages. The new *Cyberteen™* line includes airbrushed casings with colorful shapes and artwork molded right in—the perfect gift for the young consumer interested in personal defense.

## Vehicles

Surprise, surprise. Contrary to expectations, the year 2000 has not yielded any staggering new developments in transportation. Years of economic strife

### Toyota-Chrysler Omega

A typical medium sedan. Top speed about 90mph. Price around 10,000eb.

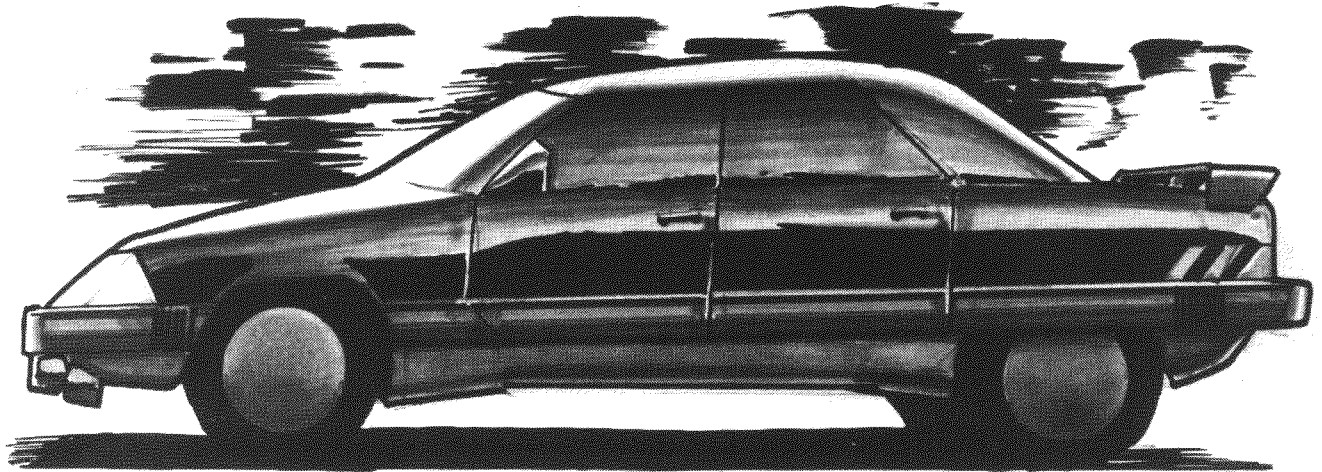

and civil unrest have discouraged research into new ways to travel—in fact, the very act of travel has become very restricted. Expect the inner city world of 2020 to be much like the 20th century—a network of crowded freeways, packed trains, and swarming airports.

#### Automobile

(Manufactured by Ford-Mazda, New American Motor, Toyo-Chrysler, Yugo-Marakovka, BMW, Mercedes, Porsche, etc.)

Powerplant: Alcohol or methane fueled internal combustion.

Groundspeed: 100 to 160mph.

Structural Damage Points: 50. Armored cars may have up to 30 SP of armor on all surfaces including windows.

There haven't been any major changes in automobiles since the 1980's—externally. Most cars are still basically a box on wheels, with smooth or hard edges. The *Cyberpunk* ethos being, "if it works, keep it till it doesn't work." In the cash poor environment of the 2000's, auto manufacturers have kept to conservative, unimaginative designs, so that by today, the average family car is little changed from its practically antique Ford or Toyota roots.

With the extremely high price of petroleum, almost all cars of the 2000's are powered by tanks of liquified methane or meta-alcohol fuels such as "CHOOH-2." Electric cars are the exception, not the rule. Control systems are roughly like those of the late 20th century employing a few more digital displays and pushbutton controls.

The biggest change has come with the introduction of cybernetic control systems. These employ servos at the wheels, throttle and transmission, which are controlled by a modified cybermodem in the dash. The driver simply "studs" into the cybermodem and thinks the car through the motions. Cybervehicles are relatively uncommon—the upgrading price is steep, and the removal of external controls renders the vehicle useless to anyone but a cybered driver. So far, no major manufacturer has produced a purely cyber-driven automobile, although there are several after-market firms which will convert a standard car to cyber control.

#### Bell Boeing V-22B Osprey

Powerplant: Allison 937 Gas Turbine  
Performance: Max speed=275 knots.  
Range=600 miles

Structural Damage Points: 200 (Ospreys are not armored).

The Osprey mounts two large, wide propped engine nacelles at the ends of long, high-lift wings. The engines can be tilted from a forward facing direction to a vertical position, allowing the aircraft to take off and hover vertically. The wings can be folded back along the body for easy storage, making the Osprey a perfect vehicle to work from rooftop airpads and unprepared airstrips.

A revolutionary concept when it was unveiled in 1988, the Osprey tilt rotor aircraft has become a standard vehicle throughout the 2000's. The military version served with distinction throughout the riots of the 90's and the Central American Conflicts. Various civilian manufacturers (Cessna, Lear, Avionica) have licenced the original Boeing design and applied it to smaller commercial and business applications. The Lear Tiltjet even applies the Osprey principles to a tiltwinged turbojet version.

Ospreys can be found as commuter vehicles between city centers and hub airports, or as corporate aircraft operating from rooftop pads atop

headquarters skyscrapers. Small versions such as Cessna's AE-800 Featherlite are popular light aircraft throughout the world, allowing flight operations in even the most remote and unprepared sites.

### Light Rail Lev Train

#### Numerous Manufacturers

**Powerplant:** Electric third rail inductance field.

**Groundspeed:** 200 mph.

**Structural Damage Points:** 80 per car of train.

Superconductor magnets have made it possible to build extremely cheap and durable "levitation trains." Riding on magnetic cushions, these "levs" have become one of the major transportation resources in the 2000's. Financed by Corporations or city governments, they are present in most major cities.

Levs are usually underground within the city limits, running on high pillars out in the suburbs. Usually one line, headed out to the Corporate suburbs, is sealed off and requires an entry code or pass to get into that station. Corporate lev stations are always clean, well lit, and well guarded by corporate security. City lev-stations are usually not up to these standards, although most cities run police patrols on the line to control crime and vandalism.

Lev-tickets are charged at a rate of 50¢ per station passed; a trip passing through three stations, for example, would cost 1.50eb. Tickets may be purchased from automatic ticket machines, using credit cards or cash. These machines are located in the stations themselves and in local convenience store outlets.

### Bell F-152 Aerogyro

**Powerplant:** one Bell-Mazda 2600 rotary aircraft engine.

**Performance:** Max airspeed: 300 mph. Operational radius: 50 miles.

**Structural Damage Points:** 40

The riots of the late 90's required new tactics for operating in urban areas.

Chief among these was the introduction of light, one man helicopters or aerogyros. The F-152 is currently used by police units, Corporate defense teams, Solo assault operations teams and drug-running gangs. An unarmed version, known as the Bell-15, is a popular recreational vehicle.

### McDonnell-Douglas AV-4 Tactical Urban Assault Vehicle

**Powerplant:** one Rolls-Royce Pegasus II Vectored Thrust Turbofan (21,180 lbs thrust)

**Performance:** Max airspeed: 350 mph. Operational radius: 400 miles.

**Structural Damage Points:** 100. Most AV-4s are armored to an SP of 40.

The nearest thing to a science fiction jet-car, the AV-4 Tac Vehicle was developed as a light assault aircraft capable of operation in close urban areas where rotary and tiltwing aircraft cannot penetrate. Short, bulbous, and equipped with only rudimentary maneuver wings, the AV-4 has the aerodynamic characteristics of a rock, relying on the brute force of its huge jet engine to keep it aloft (the original Pegasus engine lifted a 19,550 lb Harrier jumpjet, while a fully loaded AV-4 weighs about 8,600 lbs).

The AV-4 is used by police or corporate troops for urban assaults (using 2 belly mounted GAU-12U minigun pods). They are also used as emergency vehicles—specifically by the Trauma Team organizations—or as corporate vehicles for special deliveries and meetings.

### AV-6 Combat Assault Aerodyne

**Powerplant:** two Rolls-Royce Pegasus IV Vectored Thrust Turbofans

**Performance:** Max airspeed: 480 mph. Operational radius: 600 miles.

**Structural Damage Points:** 100. Most AV-6s are armored to an SP of 40.

This is a high speed, fully combat capable version of the AV-4 aerodyne, with fans mounted in heavily armored side housings. AV-6's mount cyberas-

sisted chin turrets (20mm cannon), plus rockets and missiles. AV-6's are primarily used by military units.

### AV-7 Personal Aerodyne

**Powerplant:** one Rolls-Royce Pegasus Mini-Turbofan.

**Performance:** Max airspeed: 250 mph. Operational radius: 400 miles.

**Structural Damage Points:** 50.

A recent development of the AV classes, these are small aerodyne vehicles designed to fulfill the light helicopter role. While the internal avionics and engines are usually designed by Douglas, a unique licensing arrangement permits other vehicle manufacturers to build their own body shells on the basic chassis. Manufacturers now include BMW, Mercedes, Toyota and Maserati.

## Information Services

### Letter

A stamp in 2020 costs 95 eurocents. There are usually two deliveries—once in the morning at 10.00 a.m. and once in the afternoon at 3.00 p.m. Letters are normally used for personal correspondence, or in regions where Fax machines are not available.

### Data Term

The **Data Term** is a streetcorner computer terminal, built into a heavily armored concrete post. Data Terms have a direct Net link to a central Data Term service in their home city, and can provide maps of the area, information, news updates, phone numbers, current events and entertainment information and shopping services. Data Terms may also be used to jack into the Net. Rates are about 1eb per minute.

Most Data Terms are operated by a local DT service, which is often a subsidiary of a local newspaper or screamsheet publisher.

### Fax

This is the letterwriting mode of the



future. Fax terminals are located in most corporate offices, post offices, computer shops, malls and convenience stores. You may type your letter in using the keyboard provided, have it scanned from your own laser disk, or use the built-in scanner to "read" any typed letter. The faxed copy is then transmitted by wire to a local post office in your destination area, where it is automatically typed off, inserted into an envelope, and delivered by letter carrier to the mailbox. Fax copies may also be sent directly to a Fax receiver at your destination. Fax letters cost 1¢ per page.

### Cellular Phones

The phone of the future is mobile and cordless, allowing the cyberpunk on the go to talk from his car, office, or even on the street. These "cellular" phones operate by using a series of stationary transceivers which pick up your phone signal and relay it into the regular phone Net. Calls can be made not only from within the city, but also

long distance (with a Long Distance service of your choice) all over the world and even into orbit.

Cellular phones come in a variety of brands and styles, although most are about the size of a hand held walky-talky. They operate on rechargeable batteries good for about 12 hours, recharging from a wall socket in 6 hours. Brand names include Magnavox, NEC, Okidata, GE and Radio Shack. Prices range from \$400.00 for an inexpensive model, to \$3,000.00 for models with multiple lines, built in hold-buttons and memory-autodial.

Like other phones, you must pay a monthly service charge. Baseline rates are \$40.00 per month plus 20¢ per minute for local calls. Long Distance varies—a call from Los Angeles to New York might cost \$2.00 per minute during daylight business hours, \$1.50 for evening hours. Cell phones also have a limit on how far they can operate outside of the city limits; about 20 miles.

### Screamsheets

To stay competitive with television, most newspapers now use Fax technology. Entire pages are typeset and laid out by computer, photos scanned into places, and the entire newspaper reduced to digital code. This code is transmitted to hundreds of newspaper boxes all over the area. The newsboxes reassemble the code and print the paper (using high speed xerography) on the spot. The result is a slick, flimsy newspaper known in street slang as a screamsheet.

Screamsheets have many advantages over previous newspapers. You can dial the newsbox to print only the sections of the paper you want, paying 1¢ per page printed. New edi-

tions can be compiled in hours, allowing the public to keep abreast of a story even as it happens (although most screamsheets are updated at 6:00 a.m., 12:00 p.m., 5:00 p.m. and 10:00 p.m.).

### Television & Radio

An all pervasive force in 2020, television has moved into the realm of total entertainment. One hundred and eighty one channels now crowd the airwaves, as well as various cable and subscriber channels. These cover everything including sports, news, music video, old movies, foreign shows, religious programming, debate, erotic and adult programming, business news and weather. In addition, there are at least 200,000 radio stations throughout the Western world.

In the Euro and Asian theaters, most programming is state-controlled; the BBC in Great Britain, and NGK TV in Japan, for example. In the United States, three privately owned entertainment networks predominate: 21st Century Broadcasting Network (CBN), World Broadcasting Network (WBN) and Network News 54. These networks are the broadcast divisions of three massive entertainment conglomerates, each producing records, tapes, videos, movies and books for the masses. The product is bland, mindless, and caters to the lowest possible denominator.

In addition to network programming, there are satellite feeds, featuring programming from around the world. There are also a large number of "pirate" TV stations, operating out of hidden stations and through cable and satellite patchups. These are often a major source of news and information untainted by corporate and government interference.

In addition to the now standard **high definition** flatscreen TV, experimental (and expensive; up to 10,000.000 per set) holographic TV systems are now available.



## BACKGROUND

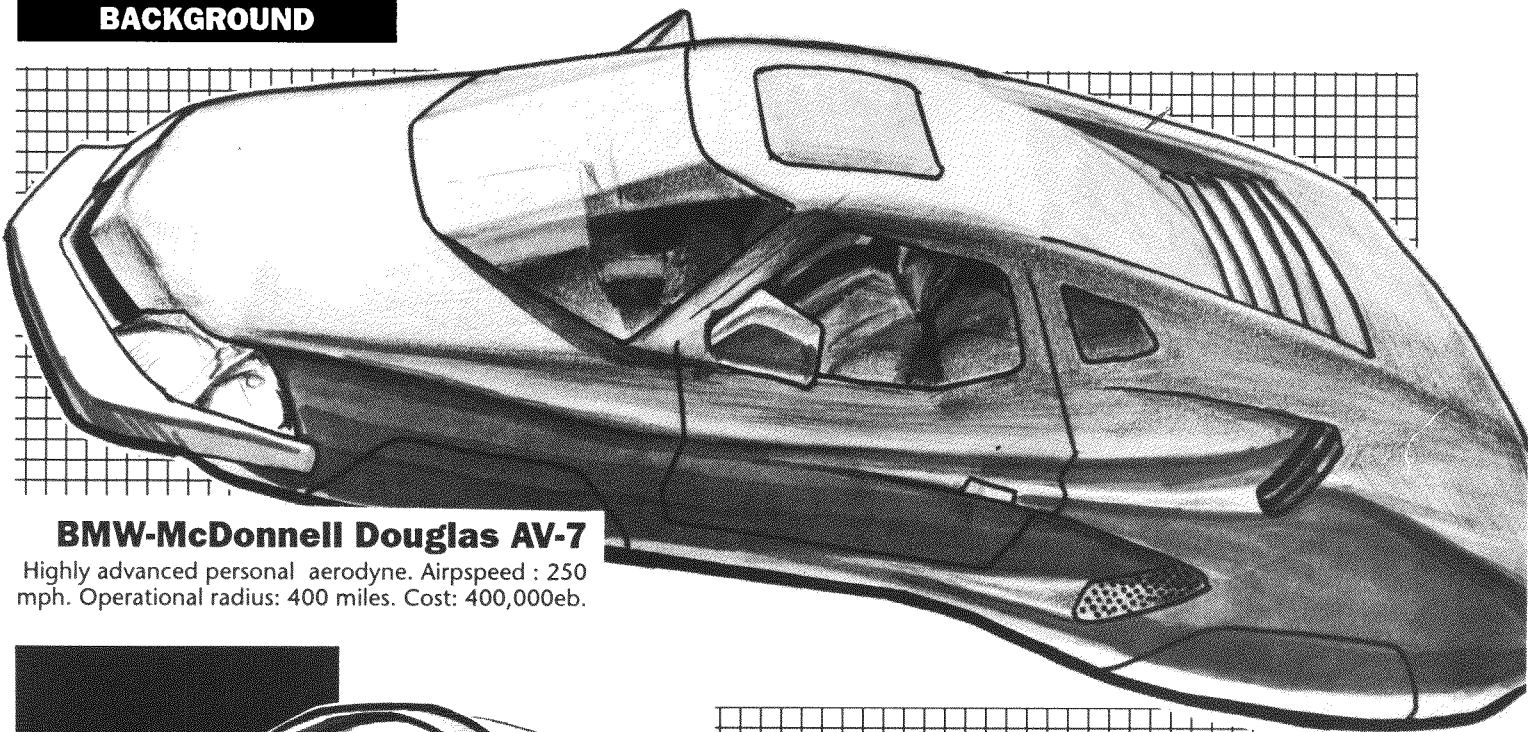

### BMW-McDonnell Douglas AV-7

Highly advanced personal aerodyne. Airspeed : 250 mph. Operational radius: 400 miles. Cost: 400,000eb.

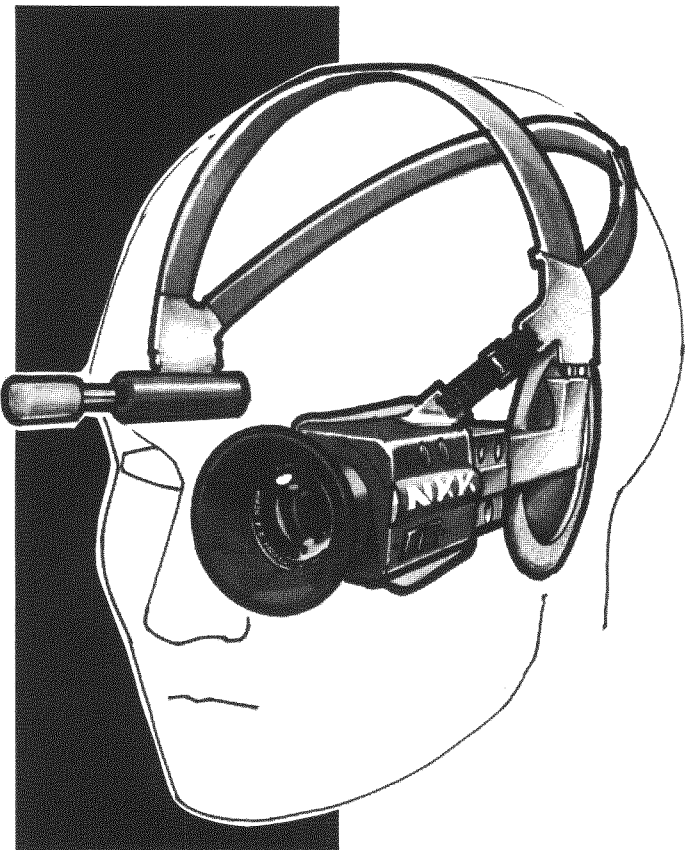

### Zetatech Hi-Profile® VideoCam

A favorite design used by Medias for mobile assignments. Pickup mike range is 200 feet. Cellular uplink allows instant transmission to Network broadcast studio. Cost is 875eb.

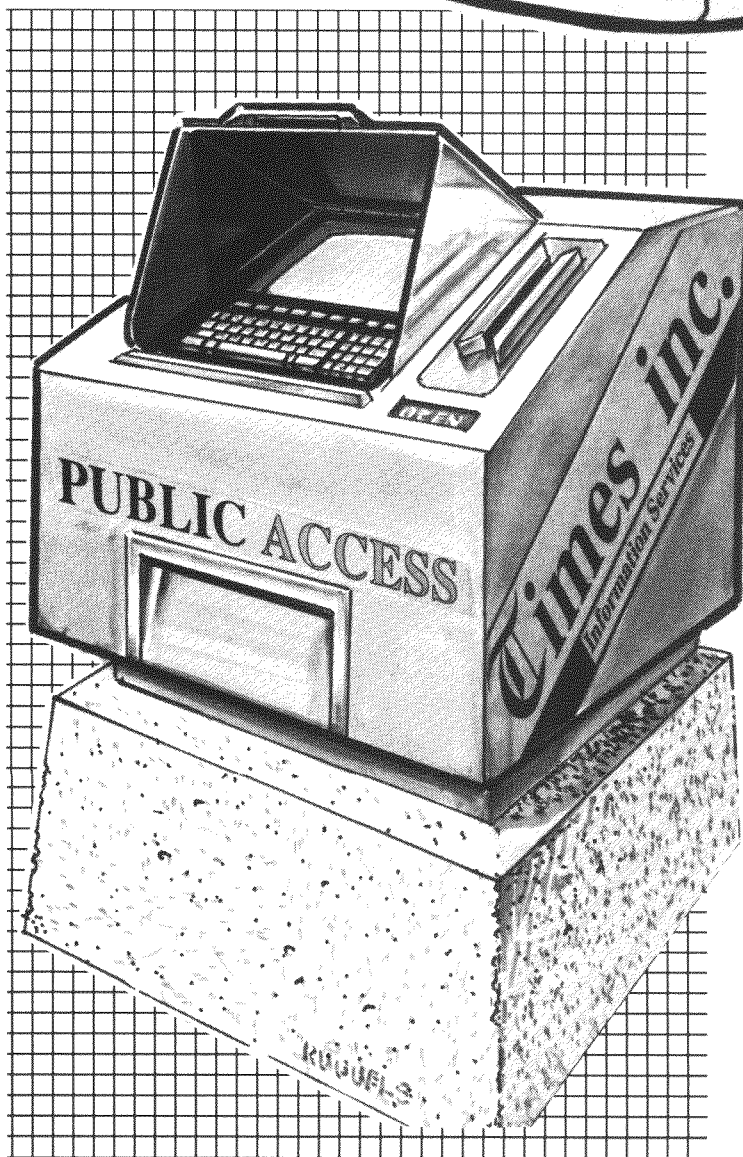

### Dataterm

Providing news, information, weather reports, entertainment news. Data Terms may also be used to access the Net and to make phone calls. 1eb per minute use.

### AKR-20 Medium Assault Rifle

Common assault rifle for battlefield combat. 500 eb.

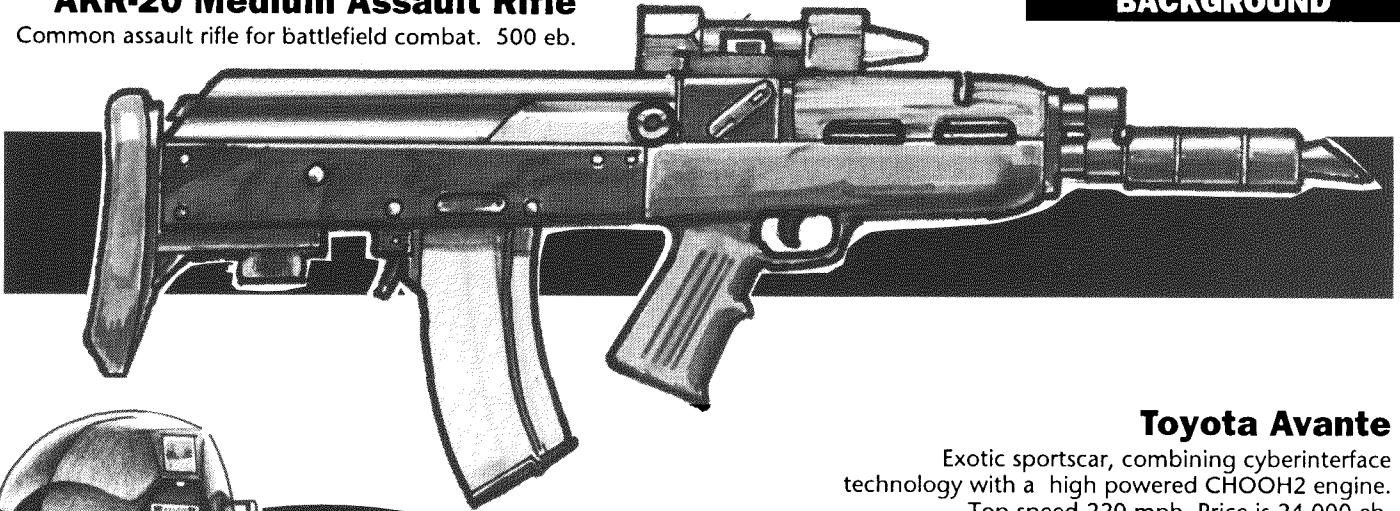

### Toyota Avante

Exotic sportscar, combining cyberinterface technology with a high powered CHOOH2 engine. Top speed 220 mph. Price is 24,000 eb.

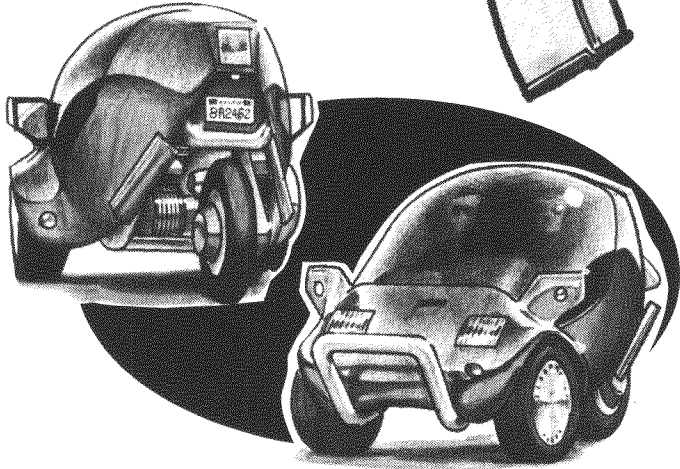

### Honda Metrocar

Common type of city car, powered by CHOOH<sub>2</sub>. Top speed about 40mph. About 2000eb.

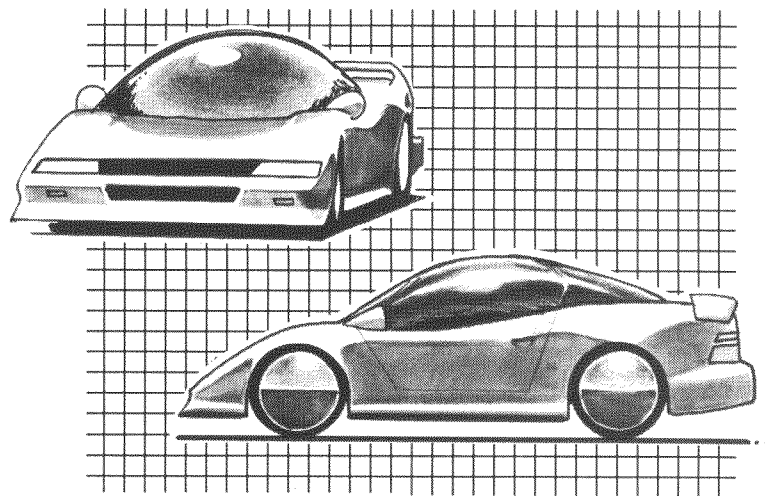

### Bell-Boeing V-22F Osprey

Heavy lift version of the original tilt-rotor craft, capable of airlifting large cargos to isolated areas. Cost 750,000 eb.

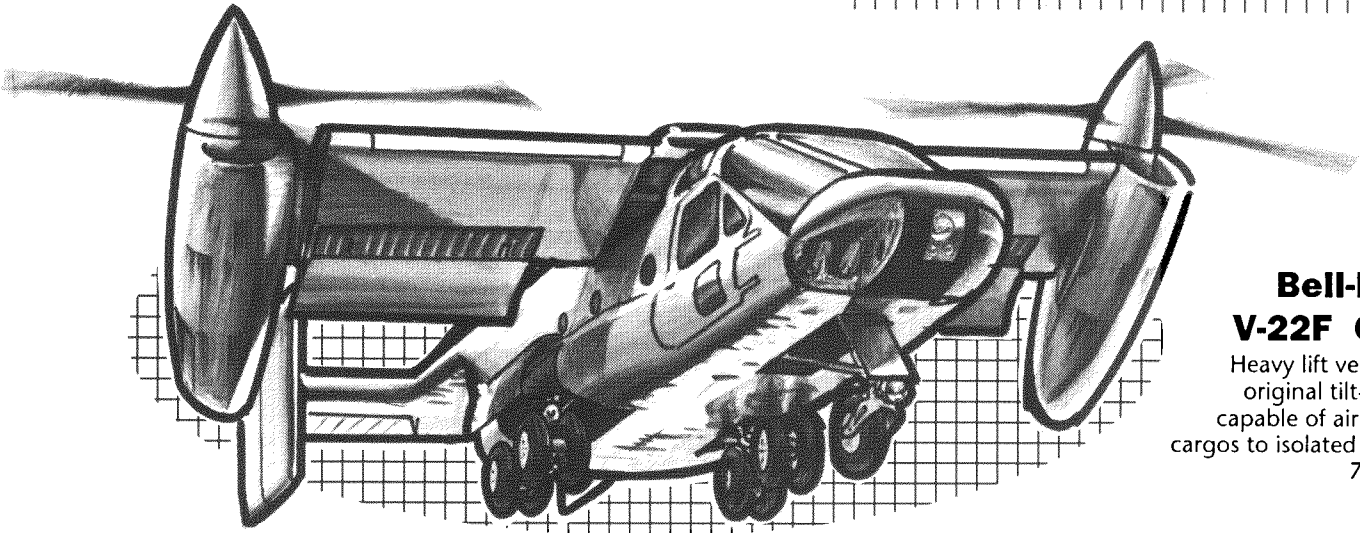

### Ford-Mazda Luxus 14

Cybercontrolled luxury car, favored by many high level Corporates execs. About 40,000 eb.

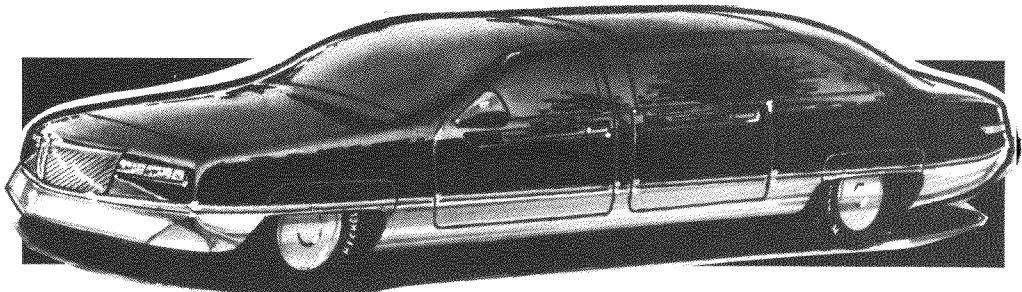

SECTION  
**12** **RUNNING  
 CYBERPUNK**

*Assorted tips, clues, good stuff and tricks of the Cyberpunk genre*

*So how do I run this game?*

Glad you asked. *Cyberpunk* is a challenge for even an experienced Referee, in that you must create the right atmosphere of grunginess, sleek technology and pervasive paranoia throughout your entire game. The *Cyberpunk* environment is almost always exclusively urban. Its landscape is a maze of towering skyscrapers, burned out ruins, dingy tenements and dangerous alleyways. In short, any major city in the world at about 2:30 in the morning when the lowlifes come out in force.

**The Urban Environment**

The urban environment is critical to your *Cyberpunk* world. Whether you use our *Night City* or create your own, remember that your setting has to have all the right elements. There should be garbage-strewn alleyways. There should be bodies lying in the gutters. There should be wild-eyed lunatics, staggering through pre-dawn streets, muttering darkly and clutching sharp knives. Taxis won't stop in the combat zones. There are firefights at the streetcorner as the local gangs slug it out. Players should find their apartments regularly broken into, their cars vandalized, their property stolen. Crossing town should be like crossing a battlefield, filled with looters, riots, crazies and muggers.

And it always rains. Every day should be grim, gloomy and overcast. The stars never come out. The sun never shines. There are no singing birds, no laughing children. (The last bird died in 2008 and the kids are grown in vats.) The ozone layer decayed, the greenhouse effect took over, the sky is full of hydrocarbons and the ocean full of sludge. Nice place.\*

\* Okay, we're exaggerating. But not much.

**Trust No One. Keep your...er..Minami 10 Handy**

Paranoia is important in a *Cyberpunk* run. Players shouldn't be able to tell who are the good guys and who are the bad just by looking at them. Choices between sides should be ambiguous—there should be no clear cut sense of good and evil, much like real life. Sworn enemies may be thrown together without notice or preparation. Heroes may have to do something illegal or distasteful to accomplish something good; villains may have to do a little good once in a while. It's the breaks.

Your world should have staggering contrasts. In the glittering citadels of the rich, there should be fine food, expensive vices, and beautiful scenery. On the Street, things should be cold, hungry and desperate. There's no middle ground between the haves and have nots. It's all or nothing.

**Know The World**

First trick to running *Cyberpunk*: **Immerse yourself in the genre.** We've given you a start with the story *Never Fade Away*—it should give you the style of speech, the urban feel, and the hard-edged realities of the *Cyberpunk* world. But you should also hit the local video-store, the library and the record shops for source material. We've included a bibliography of places to start in the sidebar.

**Play For Keeps**

Second trick to running *Cyberpunk*: **Play hard and fast.** You should not be afraid to kill off player characters. You should constantly be getting them into fights, traps, betrayals and other soap operas. There should be no one they can trust entirely, no

*"Life in 2020 isn't just all guns and drugs. If it was, we woulda named the game Dungeons & Drug Dealers.*

*The best Cyberpunk games are a combination of doomed romance, fast action, glittering parties, mean streets and quixotic quests to do the right thing against all odds. It's a little like Casablanca with cyberware..."*

*—Maximum Mike*



### A CYBERPUNK BIBLIOGRAPHY

Just a few of the most well known books in the cyberpunk genre:

William Gibson  
*Neuromancer*  
*Count Zero*  
*Mona Lisa Overdrive*  
*Burning Chrome*

Norman Spinrad  
*Little Heroes*

John G. Batancourt  
*Johnny Zed*

Joan D. Vinge  
*Psion*  
*Catpaw*

Mick Farren  
*Vickers*

Walter Jon Williams  
*Hardwired*  
*Voice of the Whirlwind*  
*Angel Station*

Bruce Sterling  
*The Artificial Kid*  
*Mirrorshades: The Cyberpunk Anthology*  
*Islands in the Net*

John Brunner  
*Shockwave Rider*

George Alec Effinger  
*When Gravity Falls*  
*A Fire in the Sun*

Steve Barnes  
*Streetlethal*  
*Gorgon Child*

John Shirley  
*Eclipse*  
*Eclipse Penumbra*

Rudy Rucker  
*Software*  
*Wetware*

place that's absolutely safe. Never let 'em rest. This doesn't mean you shouldn't play fair. But you should always play for keeps. If they cache weapons somewhere, steal them. If they stop for a rest, mug them. If they can't handle the pressure, they shouldn't be playing *Cyberpunk*. Send them back to that nice role-playing game with the happy elves and the singing birds. We've given you some great encounter tables which we suggest you use everytime the action drags (in *Friday Night Firefight*).

### Set the Mood

Third trick to running *Cyberpunk*: Atmosphere. Get out your heaviest rock tapes and play them during your run. Encourage your players to wear leather and mirrorshades. Adopt the slang and invent your own. Replace all the lights in your room with dim blue bulbs. This is the dark future here; and it can't be accurately portrayed in a brightly lit room with milk and cookies on the table.

### Teamwork; The More the Bloodier

Fourth and last trick to running *Cyberpunk*: Teams. You'll notice—*Cyberpunk* groups are not social. The players will have no reason to trust anyone, and the conventional reasons (stop evil, kill monsters) for an adventuring party won't work. A bar isn't a place to meet new adventurers—it's a place to scope out potential victims. Parties are more likely to kill each other in a firefight than divide the spoils fairly.

For this reason, you'll need a more solid "hook" on which to hang a *Cyberpunk* adventure. Our hook is the team. A team is a group of people who are already thrown together by Fate in some way which forces them to co-operate. They don't have to like each other, but they have to work together. Besides giving the party a springboard from which to work, the team also makes the adventure easier to run. Players



### A CYBERPUNK FILMOGRAPHY

Just in case you ran out of books...

*Blade Runner*

*Max Headroom*

*Terminator 1 & 2*

*Alien/Aliens*

*Liquid Sky*

*Overdrawn at the Memory Bank*

*Mad Max*

*The Road Warrior*

*Thunderdome*

*Cyborg*

*Total Recall*

*Robocop 1 & 2*

can be given assignments from a "higher power", or the entire group can be faced with a problem which requires co-operation to solve. The group stays together or it dies. Simple.

We've given you a number of Teams which might naturally evolve in the *Cyberpunk* world. Each proposes a good mix of character roles and offers many ways in which all the players can become equally involved.

**Corporate Teams:** Corporate teams are groups that are oriented around a specific corporation, working together to accomplish the company's goals. The main base of operations is the corporation's offices or security areas. A good corporate team might consist of one or more Corps (an executive and an assistant), a Netrunner (who runs the team's intrusion and computer systems), a Fixer (who deals with the team's Street contacts), a Tech (either medical or mechanical), and two to three Solos (who handle the combat).

**Bands:** Bands are any group of Rockerboys who have gotten together to play music. The band travels from place to place, getting into trouble at each new gig, holding concerts and raising hell. The main base of operations can be a practice hall, a club, or a road bus. There may be any number of Rockers in the band itself (although three to four is considered best). In addition, there will be at least one Fixer (who acts as manager), a possible Techie (to handle equipment needs), and several Solos (who are both bodyguards and roadies). Various other slots such as groupies and tour personnel can be Nomads, Corporates (playing record execs), and Medias (as rock-reporters or reviewers).

**Trauma Teams:** Trauma Teams are groups of licensed paramedics who patrol the city looking for accident victims. They operate from an AV-4 Urban Assault Vehicle, redesigned into an ambulance configuration and armed with a belly mounted minigun. A typical Trauma Team would include a driver (Corporate, Fixer or Solo, although Nomad is best), one or more Medtechies, and two or more Solos acting as "security". The team may also have a Dispatcher (Corp or Fixer) in charge of sending them on their missions. A Media might also tag along with the team, writing stories about their adventures.

**Mercenaries:** Mercs are often hired throughout the *Cyberpunk* world. A typical merc group could include at least one Fixer (to handle

contracts), one Netrunner (to handle security systems, computer assault, etc.), one Techie (for weapons), one Medtechie (for wounded), and any combination of Solos or Nomads (as grunt soldiers). It wouldn't be out of line to have a Media there, writing as a war correspondent. A merc group could operate out of a club, a bar, or a well-hidden paramilitary base camp.

**Gangs:** Gangs and countergangs are usually the enemy in *Cyberpunk*. But why not turn the tables? Gangs can also be created for positive purposes—neighborhood defense, to stop other more violent gangs, or to resist a major invasion by Government or the Corps. In this context, you could look at Robin Hood or the WWII Resistance as gangs. A typical Gang would have lots of Solos, Nomads and Fixers. There might be a Medtechie or Techie around, and possibly even a Corporate if the gang is one of those controlled by a covert organization. A Media could be covering the gang from the Street angle. Gangs operate out of clubs, bars and deserted buildings.

**Nomad Packs:** Nomad packs are natural teams—they are already together in one group, and everyone knows each other. A good Nomad pack could include a few Fixers (to handle in-town negotiations), a Netrunner (who handles the pack's intelligence work), a mixture of Techies and Medtechies, and any number of Nomads and Solos. The pack operates from the Caravan—an assemblage of RV's, trailers, buses and cars moving across the blasted landscape of freeway America. The pack members could travel with the main caravan, or as scouts traveling ahead in their own vehicles.

**Cops:** The Cop team operates out of a seedy, heavily-fortified police station. They might include a few Fixers on the Vice Squad, a Netrunner on Counter Intelligence, a Captain (Corporate) who handles connections with the City Government, and a large number of grunt Cops. Don't forget a few maddened Solos on the Psycho Squad. Cop teams are better than most, as they allow the Referee to break the team into smaller groups of "partners" if needed. A Media might also choose to follow the Cop team, looking for hot stories on the crime beat.

**Media Teams:** Media teams go anywhere, do anything to get the story. A Media team can operate out of a TV or radio station, a newspaper office, or even a major network news bureau. A good Media team might include two or three Medias (as hard-hitting reporters), a Netrunner (running communications, information gathering, and computer snooping), a



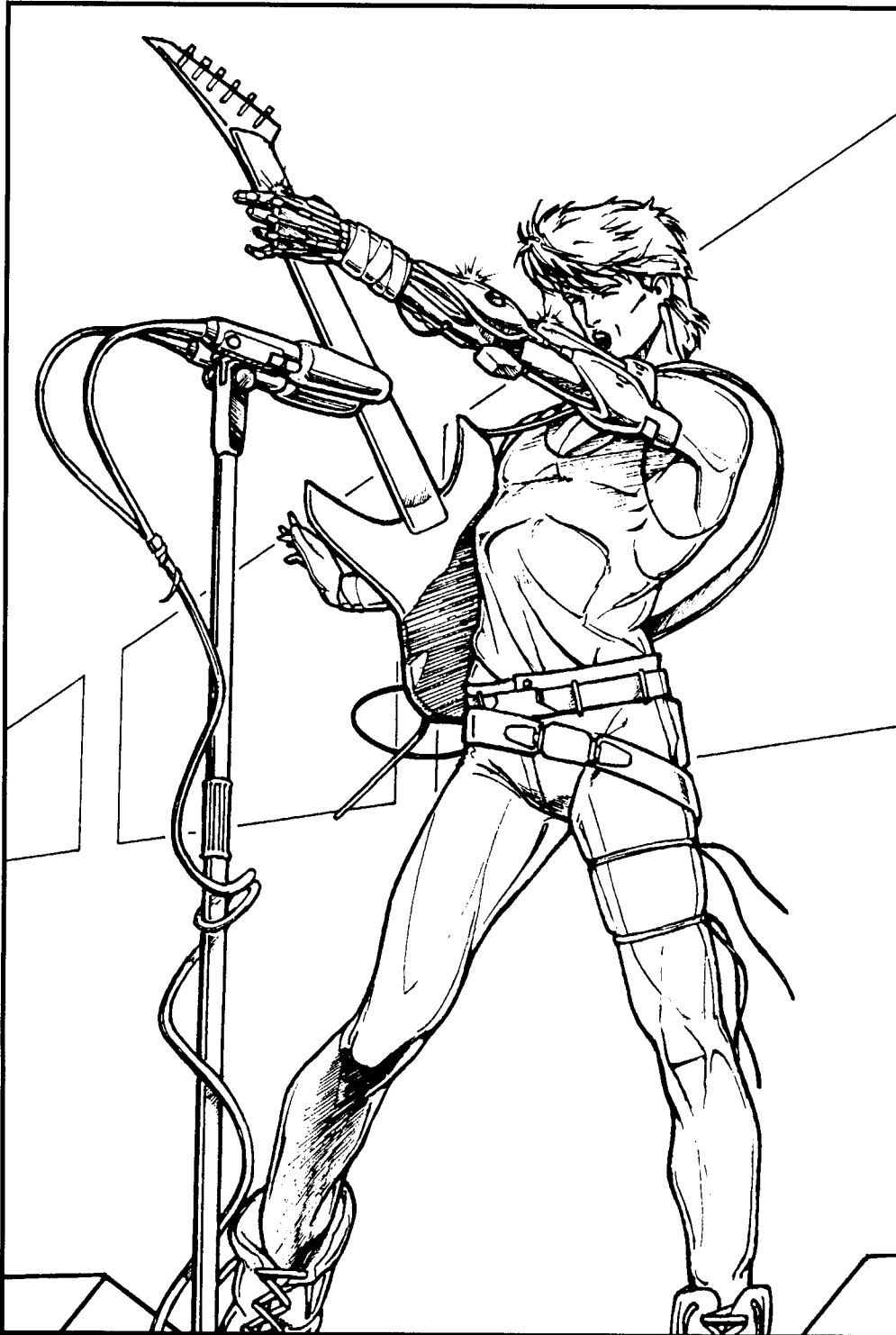

*"Sixteen and  
sixteen hundred/  
Wired with the  
max processor  
edge.  
Never die and  
never breaking/  
Throw my self  
over the ledge.*

*Have you ever  
seen the  
sunlight/  
Screaming fast  
and mean and  
low?*

*Get your self  
illuminated/  
Get yourself that  
cyber glow.*

*Made of steel  
and hard  
emotion/  
Give my love  
and face the  
day/  
In your face and  
here to party.  
Never gonna  
fade away"*

*—Johnny Silverhand  
Never Fade Away*

Techie for the equipment, and a couple Solos or Nomads to provide muscle and protection. A good newsroom also will have at least one harried Corporate who has to cover the team with the bosses upstairs.

### **Don't Give Up Your Day Job**

Any one of these Teams can fit a character role that isn't described. A low-level Rocker-

boy could moonlight as a Trauma Teamer while waiting for that big score. A Netrunner might do a little time with a Corporate team, while sneaking into the Company mainframe at night. A Nomad might do almost anything to earn money while his pack is in town. In these cases, the main character role should be treated as an interest, which may become more important to the team as time passes.

SECTION

# 13 NEVER FADE AWAY

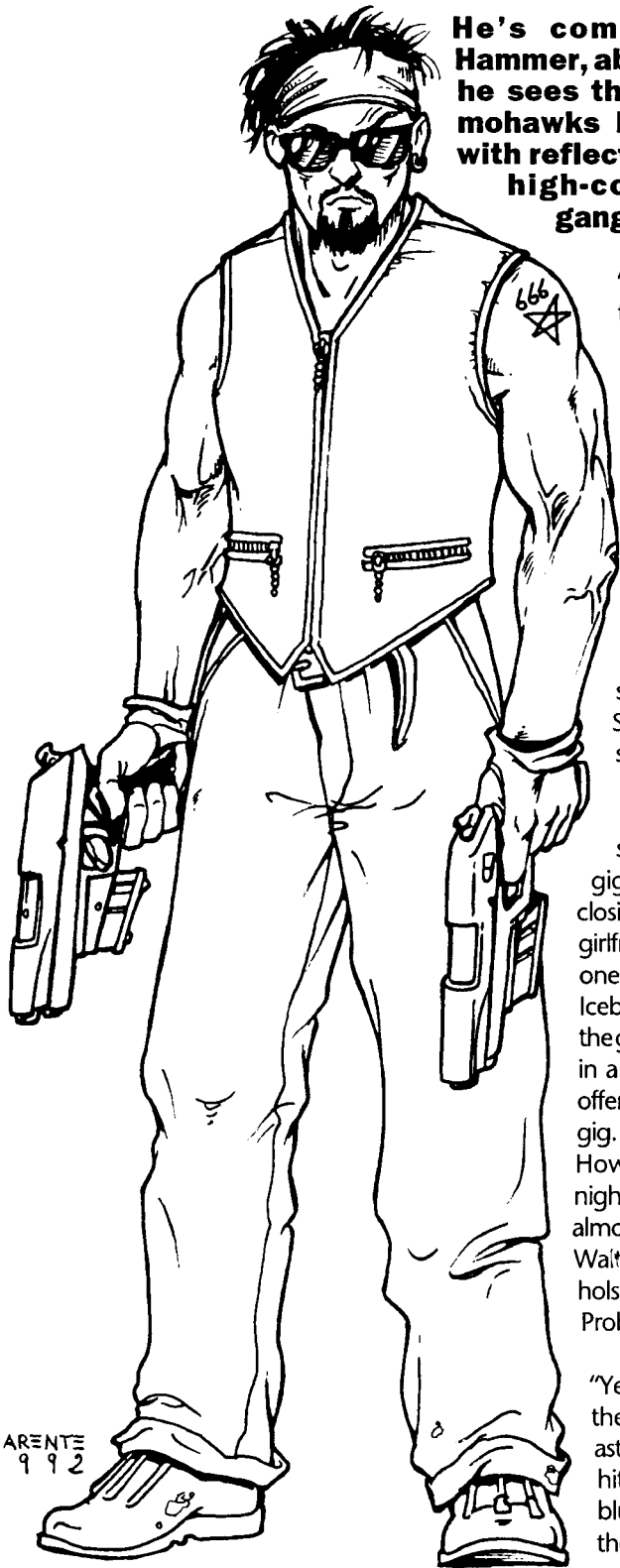

**He's coming out of the Hammer, about midnight, and he sees them. Three punks, mohawks bright and bristly with reflected neon, wearing high-collared jackets; gang colors.**

"Yo! Rockerboy!" one of them yells, "Good show! Good noise!" Johnny Silverhand waves absently. Fans. They're right; the gig was good. He'd rarely been better. But the show's over.

They start walking towards him. One waves a bottle; the light strikes oily yellow tequila sloshing to and fro. "Yo, Silver-rocker!" he says. The smaller one, with the face scarred in African tribal tattoos. "Join us! Share some! Fair price for a good gig, eh?" The distance is closing; Johnny steers Alt, his girlfriend, to his bad side. The one without the Hand. "Hey, Icebrothers," he says, noting the gang's colors and speaking in a temporizing tone. "Your offer's solid, but it's been along gig. I'm nearly flatlined as it is. How 'bout a replay, next night?" By that time, they're almost on him. He lets the 9mm Walther drop from the spring holster, settling into the Hand. Probably nothing, he thinks.

"Yeah. Replay next night!" the big one says enthusiastically, and that's when they hit him. This fast, they're a blur. The Walther booms in the close confines of the

alley; whines as spent rounds ricochet off into nowhere. There is a metallic "snick" as the smaller punk brings up his arm—light reflects off the fistfull of razors that pretends to be a hand; then an excruciating impact lifts Johnny off the ground. Blood sprays over wet concrete. Silverhand hits with a bone wrenching impact. His pale eyes stare blankly at the sky. Alt's terrified screams recede swiftly into the dark. Sixty to zero in eight seconds flat.



Johnny comes to. There's something like broken glass in his guts. Red fire blots out the cool blue neon. He rolls over in a pool of something greasy. Blood. His.

A cat topples off the dumpster, picking a cautious pattern around his body. No fool, this cat. A survivor. Not going to get involved. It's eyes are tiny red LEDs moving upalley; Johnny watches it. Smug bastard, he thinks. And closes his eyes.

Behind his eyelids, red digitals feebly clock out his remaining moments. Bio-clock running down. Cars whispering past on the filthy, rain-wet street beyond. A Trauma Team ambulance in the distance, siren screaming. But not for him. He's checking out.

***He balls the Hand that is his trademark into a chromed fist, servos clicking in one by one.***

He stares blankly up at the flat black ceiling of the city. Overhead, there's the shimmer of distant heat lightning interacting with the pink actinic glow of the City lights. The stars look painted in. A VTOL passes overhead, giant propblades thrashing the night. Johnny tries reaching up to it. He can see the Hand etched against the sky; slick, superchrome winking back at him. He balls the Hand that is his trademark into a

chromed fist, servos clicking in one by one. He thrusts it into the gaping belly wound, gasping at the shocking pain. Somehow, he gets to his feet; staggers to the alleyway. He leans his feverish face against the cool, wet bricks. He makes a decision. He's not going to die. *They're* going to die. Closing his eyes, he pitches forward into the streak of passing traffic blur.

Something stops him. Hands firmly grapple him, holding him up. Silverhand has just enough strength to open his eyes. There's a face looking intently at him, thin, bearded. "Lord Almighty", the face says. "They really *did* you, didn't they?"

Fade to black.

### TRAUMA WARD

Something is screaming when Johnny wakes up. Fine. Just as long as it isn't him. He must have missed the ambulance ride to the hospital, but here in the trauma ward he can hear the sound of jet engines. That's the screaming. It mounts higher and higher, while the ward fills with warm air and the smell of ozone. From his stretcher, he can see the bulky AV-4 vehicle spin on it's fans and hurtle upwards. The din dies down and he can hear screaming for real all around him; casualties of the regular firefights around the City.

The doctor puts him back together. The same doctor who did his transparent Kiroshi eyes; his trademark silver hand. The same doctor who "plugged" him for interface and installed the software chips in the back of his skull. Johnny considers taking out a service contract.

Microsurgical waldoes ripcut through the perforated guts, swabbing, tying off, prepping. The doctor stitches in three feet of glistening wet, tank-grown intestine; plugs the punch holes with synthetic skin and muscle. Airhypoos inject the area with speeddrugs, fasthealers, endorphins and antibacterials. Microscopic stitches hum off the serrated teeth of a mini-closer,

bonding flesh together almost as well as the original. In a month or two, there won't even be a scar. Let's hear it for newtech.

The doctor's hands are quick and sure. He has done this a thousand times. He has a German accent. "Ach...Johnny..Johnny" he says, over and over as he works. Over his head, the sterilizer lamps glitter like an insect's multifaceted eyes. "Johnny...When are you going to give this up?" says the doctor.

*When it ends*, thinks Silverhand, from the fog of the dorpha and general anesthetics. "Johnny," says the doctor sadly. Silverhand is a second son to him. His first son was Johnny's best friend. His first son was killed in an inter-corporate war eight years ago. No man should lose more than one son in a lifetime.

*Thanks*, thinks Johnny. *I owe you one, again.*

His alleyway benefactor is named Thompson; a thin, reedy type, wearing an armor jack trenchcoat three sizes too large. He packs no visible hardware. But a minicam mount straddles his head like an oversized headphone; a mike loops in front of his mouth, the camera itself coming around the right side of his skull and hardwiring into a startlingly bright green cyberoptic. He's a Media; a one man team of cameraman and reporter, direct feeding to some mediacorp downline. "Hey, Rocker", he says, leaning over the table as Silverhand recovers under the sterilizer beams.

"Ready for a little vengeance?"

### THE NAMING OF NAMES

Johnny pulls on a red T-shirt. The shirt has the logo of his last band, *Samurai*. The shirt drags over the freshly stapled wound; hangs up on the bandages. He curses in Japanese. He pulls an armor jacket over his shoulders.

### ABOUT THE STORY

*Never Fade Away* is the story of twenty four hours in the life of Johnny Silverhand, a famous Rockerboy suddenly catapulted into a deadly game of cat and mouse with a sinister Corporate foe. As the cyberpunk genre is mostly literary, it seems fitting we introduce you to *Cyberpunk* roleplaying the same way.

*Never Fade Away* is primarily a story; but we've made it easy to run as an adventure as well. In these sidebars, you'll find notes on key characters, maps of important locations, data on weapons and combat, and ideas for using the story as a springboard to the adventure.

We suggest you begin your players as characters in the upcoming scene in the *Atlantis*, hired by Johnny to help him get his girlfriend Alt back. Or your players may want to play one of the NPCs from the story.



### JOHNNY SILVERHAND

Ex-Central American vet, now Rockerboy, Johnny is the leader of a top band called *Samurai*. He's known for his musical skill, his compelling songs, and a history of trashed relationships.

#### Stats

INT 7 REF 8 CL 8  
MA 7 BODY 7

#### Cybernetics

Chromed cyberarm with recorder. Sandevistan boost. Two cyberoptics with IR, Low Lite, Enhancement.

#### Skills

Charismatic Leader +10, Handgun +6, Rifle +4, Guitar +9, Perform +7, Notice +6, Seduction +8.

#### Possessions

Heavy Armor Jacket, Light Helmet. H&K MPK-11, Arasaka Rapid Assault.

He pulls the autoshotgun out of his battered bedroom dresser, checking the load and weight. He slips it carefully into the worn under-arm holster, under the jacket. He stuffs shiriken into pockets on the outside of the jacket. He picks up the heavy H & K smartgun and slides it into his back holster. There is a fury behind glittering pale eyes.

"So," he says. "Tell me."

Thompson leans back into the wall, body bracing against Johnny's intensity. He grins; takes a slug of Silverhand's tequila. "They didn't want you. They wanted her. She's an extraction. Business as usual."

Johnny's eyes are blank. "No surprise", he comments shortly. He gathers up a ragged handfull of shells and begins to stuff-load the H&K's spare clip. Only the trembling of his hand—the meat hand— betrays any emotion. "So why'd they do me?" he asks.

***"I let you take it, because I knew it would take at least five minutes for you to bleed yourself dry..."***

"You was home", grins Thompson. It's an old line. They both smile like friendly sharks. Thompson stops smiling. "They wanted you flatlined so it'd look like a gang job. Boostergang sees the high and mighty Mister John Silverhand out strolling with his input; decides to slash him a bit. You go down, they grab her; they're gone like vapor. Real convenient when the cops find her body in an alley 'bout a week later. They'll have motives—lots of ugly motives, but they'll be those of high-powered boosters, not pros."

"Pros." Silverhand finishes loading the second clip. He stuffs the remaining shells in the armorjack's pockets. You can never have enough ammo.

"Yeah, pros," repeats Thompson. "You got shredded for fine, bro. At least a clean ten thousand Eurobucks of hardware on those boys. The speed they hit you with took maybe a seventy percent reflex boost, and

those were custom rippers. The type that fold out along the fists. That sort of hardware isn't something you pick up on the Street."

"You saw them on me?"

Thompson's eyes are cold, slate-like. You could write anything you wanted in them. "Get real," he grates. "These were pros. If I'd jumped in, we'd both be dead." The eyes appraise him. "You've been off the Street too long, Rocker. You think everyone has a nice agent, a couple Solos covering their butts, and a comfy apartment like this somewhere. I let you take it, because I knew it would take at least five minutes for you to bleed yourself dry. I waited for them to move on, then used my Trauma Card." There is a longish silence. Then, "Look, Rocker. You want to guilt-loop, or you want to get your girl back?"

"So name names," says Johnny. He sits down on the edge of the bed, favoring his stapled side. He reaches out for the tequila and takes a slug.

"Good news/bad news," says Thompson. He's unlimbered the cybercam unit from around his head and set it down on the table between them—the only indication of hardware is the silvermounted skull plug drilled through his right temple. The cam's cellular link through the NET is off. Thompson says, "Good news is, it isn't one of the really big guys, like Eurobusiness Machines. "Fair enough." says Silverhand, taking another swig from the bottle.

"Bad news is, it's Arasaka."

"Jesus H. Christ!" explodes Johnny. The Hand, resting on the edge of the table, convulses. There's a rending noise and splinters fly in all directions.

"Your input was playing with hotdeck materials, rocker. You know she ran for ITS, right?"

"Yeah. So you gotta work somewhere. Alt didn't talk much about her work."

"True. But your Alt was ITS's pet netrunner. She moved info up and down the NET and

handled their security as well. She made a lot of classy software just for them." Long pause. "She built *Soulkiller*, you know. Or maybe you didn't. Like you said, she didn't talk much about her work."

Johnny sits back on the couch, the bottle halfway to his lips. Even the normally disconnected Silverhand has heard of *Soul-killer*, the legendary black program that sucks the very soul from it's Netrunner victims. *Soulkiller*. What a joke. *Soulkiller* is a 2,000,000 meg AI super routine that can track an intruding Netrunners's cyberlink faster than a boostergang snorts drugs. It tears out the cyberpirate's brain with brutal force, recreating it in a frozen storage matrix inside the mainframe. The word is on the Street that *Soulkiller* may be the closest thing to Hell on earth, and in these days, that's saying a lot.

And Alt made that? Johnny bites down a momentary wave of revulsion, superimposed over Alt's big green eyes, tousled mane of hair. "No wonder she didn't talk about her work," he says finally.

"I was following her, Rocker," says Thompson. "Word's out that Arasaka is working on it's own version of *Soulkiller*. Something that can walk the NET freely, getting up close and personal with people Arasaka doesn't like."

"A black program assassin for a security company?" Johnny is up and pacing now. He knows where this is going, and he doesn't like it.

"You probably believe in Santa Claus too," says Thompson, reclaiming the dregs of the bottle. "Your Alt is the missing link. I figured they'd have to recruit her sooner or later, whether free or forced. *Soulkiller's* main programming is buried in her head somewhere. So I followed her."

"Thanks for the concern."

"You don't get it, Rockerboy. I want Arasaka. I want them bad. I'll put anyone and anything on the line to get them. Even myself—if I have to broadcast this story from the grave, I'll do it. They're mine. You get in my way, you're flatlined. You go with me..." Thompson lets it trail out.

Johnny stops pacing. The room goes still. Only the Hand moves, like something alive; silver metal joints clicking, takeup reels whirring, tiny pistons shooting in and out in simulation of a pulse. The Hand turns Johnny to face the mediaman. It makes him say, "How long do we have?"

**Thompson reaches down to his feet; draws up a long black, nylon bag. "FN-FAL assault," he says, standing up. "I was in the War. I like lead. Lots of lead."**

Thompson smiles lopsided. "How long will it take your input to rewrite *Soulkiller*? A day? Two?"

"Yeah." Johnny turns, scoops up the keys to the Porsche. "You chipped for a smartgun?" he says. Thompson reaches down to his feet; draws up a long black, nylon bag. "FN-FAL assault," he says, standing up. "I was in the War. I like lead. Lots of lead."

Rain runs down the front of the speeder. A wall of Corporate glass and steel looms to either side as they pull out into the downtown traffic. The Porsche whistles slightly in the chill air, it's methanol powerplant throwing it against the City night. "So where are we going, Rocker?" says Thompson.

Johnny grits his teeth. "I've got a marker I have to pull in," he says.

## ROGUE & SANTIAGO

Rogue hates the Atlantis. But she goes there because the contacts are good, and the pickings easy. Corporates looking for a fast freelance assassination. Medias and 'Runners looking to trade information. Fixers with guns, armor and smuggling jobs. But the place has bad memories. She only comes here because Santiago insists on it.



### THOMPSON

A top reporter for World News Service, Thompson has a running feud with the infamous Arasaka Corporation, whom he suspects of having murdered his wife. He will do anything to get the elusive security firm—anything. Thompson also served in the Wars as a correspondent, and is fond of heavy weapons.

#### Stats

INT 8 REF 8 CL 7  
MA 8 BODY 8

#### Cybernetics

One cyberoptic with IR, Low Lite, Targeting scope. Cyberaudio with radio splice, scrambler, chip recording.

#### Skills

Credibility +8, Rifle+6, Interview +9, Composition +7, Athletics +6, Notice +6, Intimidate +5.

#### Possessions

Med. Armor Jacket, Light Helmet. FN-RAL Hvy. Assault Rifle.





### ROGUE

Rogue and her partner Santiago, are hit men and bodyguards. The word on the Street is that they're the best. Rogue's one weak spot is Johnny Silverhand, her ex-lover. Their violent, passionate relationship disintegrated in a massive blowup a year ago, but the scars haven't healed yet for this hardbitten Solo.

#### Stats

INT 7 REF 12 CL 9  
MA 10 BODY 8

#### Cybernetics

Two cyberoptics with IR, Low Lite, Targeting scope, Sandevistan boost, Karate chipped to +3.

#### Skills

Combat Sense +9, Handgun +10, Brawling +9, Drive +7, Rifle +10, Melee +6, Athletics +9, Notice +8, Seduction +8.

#### Possessions

Med Armor Jacket, Light Helmet, Armalite 44 Very Heavy Pistol.

"You don't let personal caca get in the way of business," he says. A lot he knows.

Her back is to the wall of the booth—her mirrorshaded eyes scan the room like monitor cameras. What she can't see is covered by her partner, Santiago, from the opposite side of the booth. His burly shoulders bulk the heavy armor jacket—he looks like scowling mountain. He's not her type. But he wants her. Somehow, they've managed to work this out—the way they worked out a combat style; the division of spoils. But he keeps hoping. Stupid Nomad.

Then she finds herself facing what she's dreaded for the last two years; the reason she hates this crummy bar; hates this crummy town. Johnny Silverhand walks into the Atlantis.

He still has the moves, she thinks, as he strides through the big brass doors. Head held high, a cocky light in his pale glass eyes. After all this time, Rogue still can't decide whether she wants him, or just wants to kill him. He looks like he owns the place as he crosses the room towards her; a comment to an old friend here, smiling at a fan there, a narrowed glance at a potential troublemaker; then he's standing in front of her. "Rogue," he says. Like nothing'd ever happened. "I need your help, Rogue." His voice is urgent, magnetic.

"You can go to hell," she replies levelly. On the other side of the booth, there's a faint sound as Santiago slides one hand over the Mac 10 in his lap.

Johnny leans closer. "Look," he says, "I'm sorry. I know how you feel. I wouldn't do this if I had any other choice. He pulls up a chair and straddles it, staring at her. "Tough." she shoots back acidly. She hopes her voice sounds steadier than she feels.

"You owe me one," he says, his voice taking an edge. "For Chicago. You owe me one at least. And it's not like I won't pay you. I've got euro."

"How much?" interjects Santiago. Johnny turns to face him. "Word on the Street is you're pulling five grand a night. I'll match and double it. "

Santiago's eyes grin in his swarthy face. He scratches his chin with his free hand. His partner has a real mad on about this guy. But he's a Face—he's got credit; that pulls weight in Santiago's world. "How long?"

"Two days max. I need an extraction. I won't haze you—it's Arasaka." A long pause. "I'll understand if you think it's too much for you."

**Rogue reacts, her chipped reflexes kicking into overdrive. Her hand is a blur as it stabs up off the table, the bunched knuckles smashing the Solo's nose back into his face. He's dead before he hits the floor...**

Santiago's eyes narrow. On the Street, their team is known as the best. Who does this choob think he is? Then the nomad realizes he's being baited. Silverhand's already figured the score between the two partners. If Santiago backs up on this, it'll be all over the Street tomorrow. If he goes with it, Rogue's going to have to back his play. Rogue's right—Silverhand is a bastard. Santiago grins. He can take this punk with one hand behind his back. "It's going to cost you thirty thou, Roker."

"Done."

Santiago grins and raises the stakes. "And you come with us," he finishes. From her side of the booth, Rogue's eyes smolder at her partner. She'd object, but the rule of the game is, "You don't let personal caca get in the way of business". When Johnny pulled out his wallet, as far as Santiago was concerned, it became business.

"Done" says Johnny. He is reaching out across the table to match grips with the big Nomad when one long shadow falls over the table, then another.

"Ah, Mister Silverhand," the bigger shadow says, leaning close. You can see red LED light scrolling behind his optics, forming crosshairs as he brings the smartgun up.

Rogue reacts, her chipped reflexes kicking

into overdrive. Her hand is a blur as it stabs up off the table, the bunched knuckles smashing the Solo's nose back into his face. He's dead before he hits the floor, but spasmed muscles tighten on the trigger of the big Beretta. There's a deafening BOOM! in a very small space, but Johnny's boosted reflexes have already thrown him up and over. There's a scream as the slug rips through the back of the booth and blows through the chest of a Corp sitting on the other side of the thin wall. Rogue's other hand fires the silenced Automag from under the table, ripping the smaller solo in half.

Santiago rolls, hitting the floor. Over by the bar, three figures in armorjackets stand up, weapons in hand; Santiago's MAC 10 hammers a short burst. The figures go flat; one staggers back into the window and falls through in a shattering sound like a hundred dropped chandeliers. Thompson brings up the FN-FAL with studied nonchalance, covering the two remaining, prone figures. "Gotcha," he says.

Johnny hits the bar floor; gun high and eyes scanning the corners. Patrons keep their hands away from weapons—everyone plays cool. The disemboweled Solo on the floor whimpers. Back to back, the four of them edge out of the bar.

## RUNAWAY

"We are seriously tagged," gasps Rogue as they hit the sidewalk. "They must have tracked my Trauma Card," grunts Thompson. "Guess they wanted to finish the job. You know some nice people, Rocker."

They reach the Porsche just in time to see the shadow of an unmarked AV-4 sweep over it. Garbage, oil, and filthy water explode into steam as the jet exhausts hit the pavement. Rogue is already down, drawing a bead on the cockpit with her .44. Above her head, Santiago's MAC 10 roars in deafening staccatto. The tiny red spot of her laser scope pinpoints the AV-4 pilot's forehead, even as she sees the minigun sweep around towards them. She's not going to make it. The canopy's got to be armored. She doesn't even have time to watch her life flash before her eyes.

Then the laserdot is eclipsed by a screaming WHHHHHOOOMMMMPPP! as something slams into the AV-4. The entire canopy—the entire front of the aircraft bells out in a horrible slow-mo inferno—a rancid smell of hot metal, melted plastic and



### NOMAD SANTIAGO

Santiago is a Nomad who runs with the Aldecaldos Pack; displaced farmers thrown off their land by the Corporations. Santiago is a simple guy—he likes girls, guns, and fast cyberbikes. He teams with Rogue mostly because she's the one girl he hasn't been able to score with yet.

**Stats**  
INT 5 REF 11 CL 9  
MA 10 BODY 10

**Cybernetics**  
Two cyberoptics with IR, Low Lite, Targeting scope, Kerenzikov boost, Cyberarm with Kevlar armor, 9mm SMG. Cyberleg with 9mm pistol in thigh holster.

**Skills**  
Family +8, Handgun +9, Judo +9, Drive +7, Rifle +9, Melee +9, Athletics +9, Notice +8, Seduction +8.

**Possessions**  
Heavy Armor Jacket, Light Helmet. AKR Medium Assault Rifle, Bimoda Cyberbike.

### THE ATLANTIS

It's your turn to tackle the *Atlantis Firefight*. Start with the Basic Goons on page 186. They've just walked in to the front door. Pick a place where your party is sitting. It's time to rock and roll!

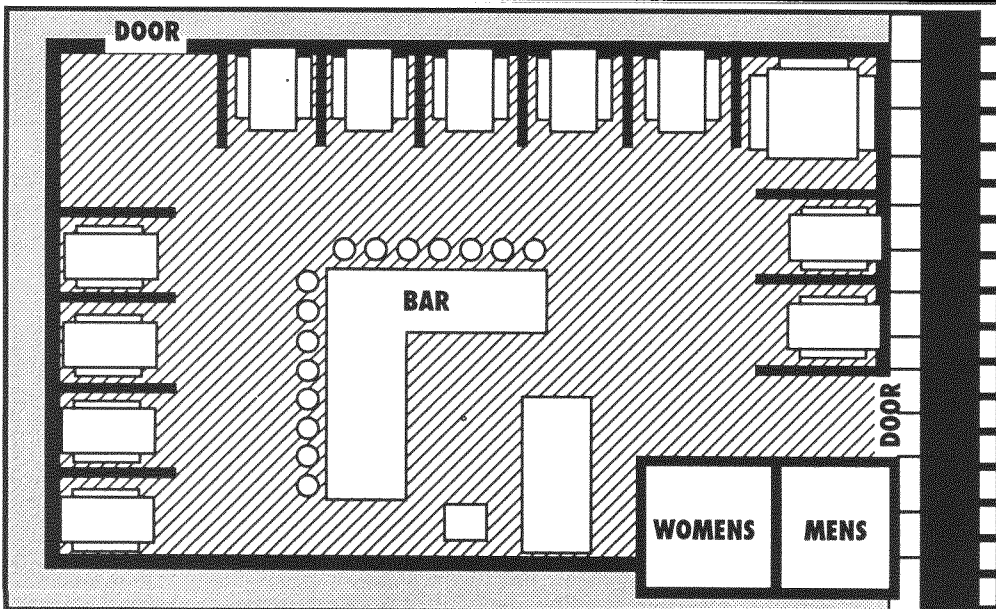



seared flesh gusts against her as the AV tilts to one side and drunkenly impacts the street. A fireball shatters the night. "Love those grenade launchers," smirks Thompson, lowering his steaming FN-FAL.

**Santiago's MAC 10 hammers a short burst. The figures go flat; one staggers back into the window and falls through in a shattering sound like a hundred dropped chandeliers.**

"We gotta get out of here," grits Johnny from behind a parked car. Rogue looks into his eyes—she can see the faint red etching of a targeting pattern flickering in their pale depths. "Right," she says, already up and moving. Her breath catches ragged in her throat as they run back into the shadows.

Santiago takes point; he knows all the best boltholes in the area. Thompson is next, the big FN-FAL sweeping their way like a flashlight. Johnny keeps his H&K close to his body; his nerves are tingling with booster effects; he's running like he's on speed. Alleyways streak by as blurs—he compensates his time sense. Rogue is covering the rear, and he can hear her breathing behind him. He says over his shoulder to the breathing dark shadow, "I'm sorry, Rache."

Her voice is flat. "Never call me that," she says. "Never again." He keeps running. "Okay," he says finally. "fair enough."

She stops running. She says, "Why Johnny? Why now? Couldn't you have gotten anyone else?" She can hear him slow ahead of her. He says, "I needed the best. And you're still the best, Rogue."

The best. Damn him.

### ALT

She wakes with her mouth full of cotton wool. She's smart enough to keep her eyes closed; to stifle any urge to scream. Boosterboys like it when you scream. They like

it so much, they'll do anything to make you scream over and over again.

Alt silently triggers commands to redline her senses to maximum. She's relieved to find herself still clothed and relatively unharmed. Not typical Booster, but she won't complain. Her enhanced hearing picks up breathing nearby; the click of glasses and ice, computer terminals. Definitely not Boosters. Alt takes a chance and opens her eyes, spits out the gag.

A slender, Asian-looking man is watching her. Neat, well-tailored suit. A glass of real Scotch in one hand, which he offers towards her. "Welcome, Ms. Cunningham", he says, his mouth smiling and his eyes frozen. "I am Toshiro." He gestures towards another man; a hulking presence lounging by the bar. "This is Akira", he says.

Alt sits up slowly, cautiously, her boosted senses giving her clues. The comforting weight of her plastic autogun is missing. But she still has her cybered arm. "Can I get a drink of that?" she says, gesturing towards the glass in Toshiro's hand. "Certainly" he says. A gesture to Akira, and the hulk turns obediently to mix a drink. Alt is surprised at the grace of the big man's hands. He moves like an athlete. He moves like a professional killer. Akira brings her the drink, and Alt doesn't even think about making a break for it.

"Thanks." The drink cools the pounding flame in her head.

"Certainly. It is the least we can do for a promising new associate."

*Bingo!* she thinks. She's been grabbed by corporate headhunters. Fine. Great. She can deal with it. Just learn the rules, play the game, and go to work. After a week, it'll be just like checking into work at the ITS offices. "So..." she says cautiously. "What kind of work do you have lined up for your new...um...employee?"

Toshiro leans forward, setting the drink down on the couch. He says, "So." He says, smiling, "Ms. Cunningham. I wish you to tell me all about the program you call...*Soulkiller*."

Her blood freezes like a silenced scream



### BASIC GOONS

These are the type of disposable cannon fodder that often shows up on the Street. They're just what your players need to get themselves blooded and ready for tougher challenges.

#### Stats

INT 5 REF 10 CL 5  
MA 6 BODY 9

#### Cybernetics

One cyberoptic with IR, Targeting scope, Karate chipped to +3, Rippers.

#### Skills

Combat Sense +5, Handgun +5, Brawling +5, Drive +7, Rifle +5, Melee +5, Athletics +5.

#### Possessions

Med Armor jacket, Light Helmet. Sternmeyer Type 35 Heavy Pistol.

### A GATHERING OF HOSTS

"So this means we've gotta punch into the main offices of the most rabidly paranoid security company in the universe," considers Santiago. "Homeboy, you pick some great places to lose your women."

"Stuff it," cuts in Rogue. "Here's the plan."

Johnny, Santiago, Thompson and Rogue. They are perched two hundred feet in the air on a rusting fire escape. From their vantage point on the blackened brick side of the old Mark Luxor Hilton they can see ten blocks in any direction. Rogue's eyes are switched to infrared, scanning for AV's and airogyros. Johnny is watching the street below. Thompson is scanning the radio chatter and Santiago is talking. "We go in," he says. It's been two hours since the firefight.

"Fair enough," replies Rogue. "But we do it ASAP." Santiago grins. "You got a reason?"

"Getting shot at always pisses me off," she grins back. "Besides, I figure they're combing the Street right now, looking for us. They'll expect us to be trying to ditch them—they'll be putting their best out to find us. Meanwhile, the second stringers are guarding the offices."

"How you figure they're holding her in the Arasaka office complex?" says Johnny. The Hand is in standby mode, running a test routine. Servos click and whirr and silver fingers spasm and flex of their own volition. Thompson speaks up. "Makes sense. The only mainframe big enough to run *Soulkiller* is in the main Arasaka building. Either that, or in Tokyo. We're not a big enough problem to rate flying her all the way back to Japan."

"Thanks."

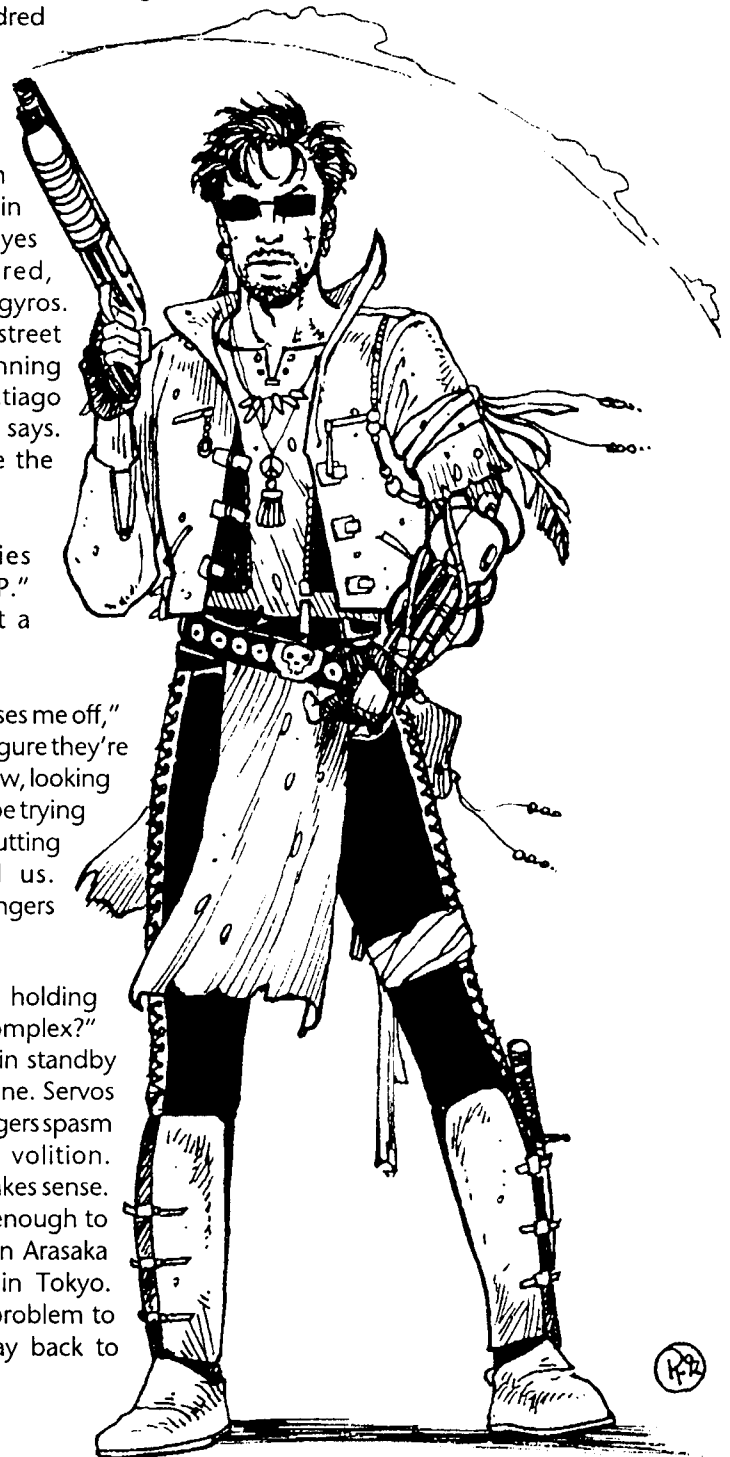

KPZ



### INTERFACE THE MUSIC

Headfirst in the Net, Alt weaves magic.

They've studded her into the Arasaka mainframe, given her room to run, hemmed in only by three Arasaka netranners who watch her every move. Her body lies comatose on a contour couch, linked by cables to a cybermodem. She's pulling down subroutines, crunching the compilers, getting comfy with the CPU's. From memory and notes, she's recreating *Soulkiller*, the eater of minds.

*Soulkiller* is a stationary program, locked to a part of the system architecture. The challenge Toshiro has given her is to give it movement—the ability to navigate the Net on it's own.

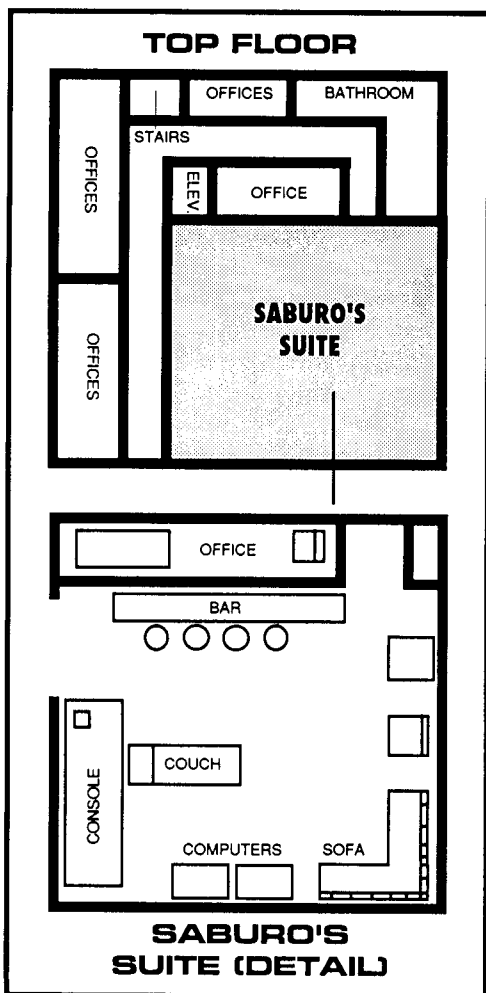

It's a subtle problem—navigation data and decision subroutines take up a huge amount of memory; the reason freeroaming programs are so limited in scope. *Soulkiller* already eats a lot of megabytes, to make it freerunning will take more memory than any normal computer can handle. The problem excites her professionalism even as the creation revolts her humanity.

God, they know her so well.

The original *Soulkiller* started as a matrix to contain artificial personalities. She'd studied the concept, worked out the parameters for creating a storage matrix. She'd been fascinated and awed to discover that the same matrix could contain living engrams; transfer them from computer to body and even back again. It was immortality.

ITS had taken it from her to build a killer. And she hadn't known how to stop them.

Now Alt looks over her options. If she doesn't build Arasaka's monster, they'll torture or kill her. If she builds their horror, they'll keep her alive. But.

But once it's built, they'll put her into it.

### WAR PARTY

A plan hinges on strange elements.

Rogue leaves their motel bolthole at nine. She moves fast, travels light, moving from place to place. Here, she picks up five pounds of plastic explosives; there, flash-bombs, timers and tripwires. Santiago covers her. He picks up more explosives, a combat assault cyberdeck, and a long, bulky black sniper rifle.

Johnny's on the cellular, working the connections. He pulls his bandmates in from around the City, carefully dodging the phone taps, shadows and snoops. He sets the time and place and the gig is on.

Thompson is on the Street, working hard. A phone call here, a tip to the screamsheets

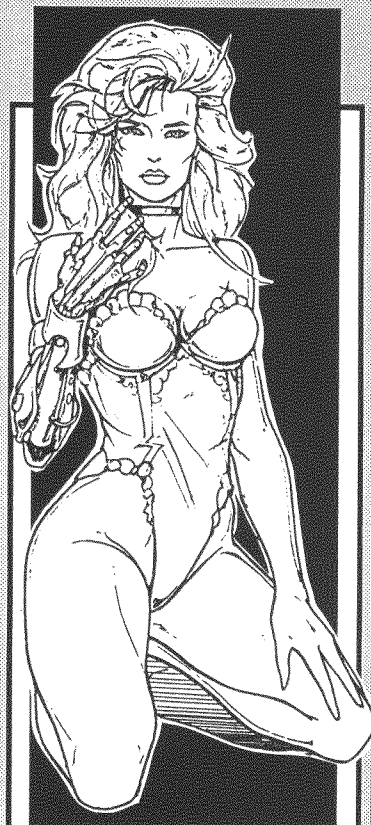

### ALT

Johnny's new girlfriend, Alt has a history he hardly suspects. A hotshot programmer and Net whiz, she's written an incredibly deadly program that can suck your mind out and eat it. But Alt is no helpless heroine, as Toshiro learns to his undoing.

#### Stats

INT10 REF 7 CL 9  
MA 6 BODY 6

#### Cybernetics

Interface plugs. Gold cyberarm with hidden compartment.

#### Skills

Interface +10, Handgun +2, Drive +4, Athletics +5, Notice +8, Seduction +7.

#### Possessions

Light Armor Jacket, monoknife, Federated Arms X-22 pistol.

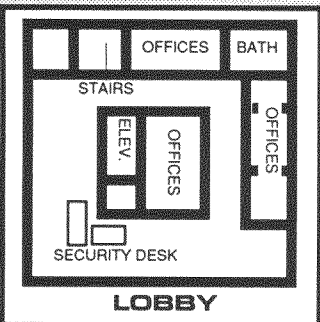
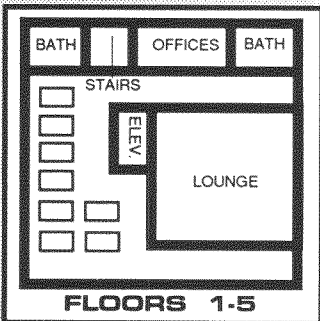
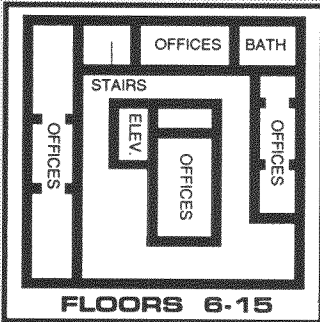
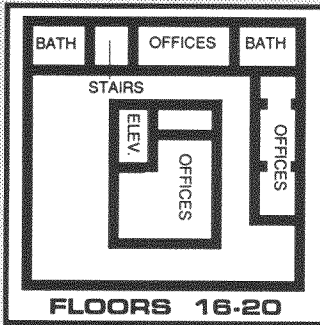

### THE ARASAKA FLOOR PLAN

Here's the internal layout of the Arasaka Tower. Place your players at the front door, about to enter the Security Desk area. At the start of the attack, the guards have been overwhelmed by the mob rampaging through the lobby, and may not attack the players for three rounds.

there. A Fixer picks up a little euro on the side, and passes the word down. By ten a.m., the Street knows there's going to be a party. By noon, the word is all over the Street—the band is Samurai, the time is sundown, and the Smash is free.

By one, the Street knows the party is going to be on the edge of town at Industrial Park.

Arasaka's twenty two story office compound faces Industrial Park.

Like a single, hungry thing, the mob converges.

## SORCEROR'S APPRENTICE

7.29 p.m.

The twisting construct spins, a blazing pillar of white fire, sparkshowers of stars. A glowing DNA chain, a whirling dervish takes shape and form, in the construct reality of the interface, towering above her, looming like fear itself. Dazzling, it exudes the palpable scent of terror. It speaks in a voice like crystal, and momentarily Alt's breath is taken by it's perfect, murderous beauty. "I am." it sings triumphantly to the cold stars.

"I am your Controller." Alt replies. "You will follow my commands." A slight hesitation in her voice.

"As always," it says, as though doubt had never existed in the universe. "What is your bidding, Mistress?"

Alt lets out a long, exhausted breath. She's gotten the Controller override past her watchdogs. Now she has a chance.

"This is what I want you to do," she begins.

## PARTY HARD

Seicho Harada is second in command of Security for the Arasaka complex at Industrial Park. Seicho is afraid. Since early afternoon, the people have been pouring into

the large, grassy park opposite his guard position; at first a trickle, then a stream, then a torrent. He can't figure it out. They don't do things like this in Tokyo. In Tokyo, people are consistent. They make sense. Here, people are animals. He thinks about calling the City Cops, but that would reflect badly on Arasaka. The world's largest security corporation calling for help? What a loss of face. But there are six thousand people crammed into the tableau in front of him.

Up on the makeshift stage, acting as though invulnerable, struts Johnny Silverhand, working the crowd up. Seicho wants him. He wants him dead. But Silverhand might as well be on Luna as far as Arasaka is concerned. A single gunshot could trigger a riot of unbelievable proportions. Seicho can feel the tension building. So can Johnny. An invisible thread binds them as adversaries, eye to eye over a battlefield of unwitting bodies.

Johnny smiles. He's got them, so far. The crowd is paranoid—they expect to be thrown out at any minute. He's been pumping them for the last hour with chromatic and metal rock, getting them edgy and irritable; in a party mood to scream and shout, kick some tail. The first uniformed bozo who interrupts their party is going to get himself hosed.

*Got the chrome in the bloodstream  
Got a metal soul,  
I'm out looking for action,  
Guess I'm on a roll*

It's like driving the freeway at two hundred miles per hour. The crowd swells and breathes as the first verse goes down, taking on the cohesiveness of a living thing. The bass player picks up the back beat and the two of them slam into the next turn of the song, dragging the crowd with them.

*Got the old mega violence,  
When I boost, it's for real,  
The capacitors roarin' inside my brain  
You know just how I feel*

*Cold chrome, molten lead  
Can't be hurt cuz I'm already dead  
Ain't no time as real as realtime  
I'm chipping in  
Chippin in.*

### THE ARASAKA TOWER

Here's the story. The group that Johnny is leading numbers about 100 people. There are twenty guards facing the park. Each turn, roll 1D6 for the Arasaka side and remove that many people. Then, roll 1D10 for the crowd and remove that many people. When the guards get down to four men, they'll break and run. Meanwhile, you and your group should use the crowd as cover to get into the building. Good luck, chomba.

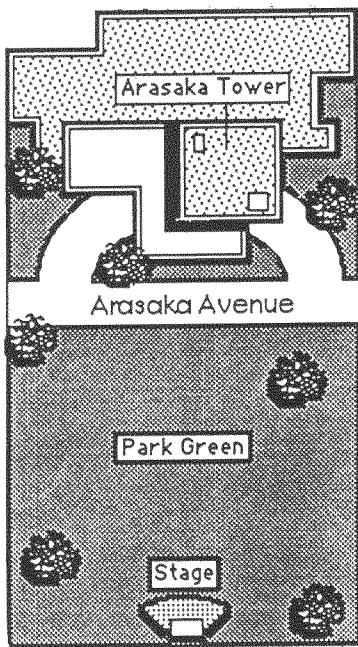

Johnny's eyes scan the perimeter of the park. To one edge, he can see Santiago in position on the rooftop opposite of the Arasaka complex. Deep in the crowd, Thompson and Rogue are poised, ready to make the break. All he has to do is give them the chance; the diversion.

All he has to do is turn around and lead six thousand people right into a wall of weapons.

*Chippin in (got my head to the wall)*  
*Chippin in (can ya hear me call)*  
*Chippin in (I'm the man of steel)*  
*Chippin in (Is that how ya feel?)*  
*Well, comon!*

The moment freezes, hanging in air like a death. Punching his battered Telecaster

guitar over to "remote", Johnny leaps off the stage, pushing his way through the crowd. His voice holds solid over the radio mike; powerful, pleading, entreating, seducing, and the huge crowd turns with him; surges around him, swallows him. It's knifeedge balanced—six thousand people teetering on the edge, chanting, singing. At the perimeter of the park, Arasaka police stand guard nervously, their eyes riveted on the mob. Silverhand starts towards them, and they choke on the decision—twenty guards facing down a wall of humanity, centered on one man whose voice holds them, binds them. An assault rifle comes up, and the crowd, like an irritable dog, notices the small army facing them down. The scene is set; the guards distracted, and on the rooftop, Santiago takes aim...

***It's like driving the freeway at two hundred miles per hour. The crowd swells and breathes as the first verse goes down, taking on the cohesiveness of a living thing.***

Then it goes wrong. One of the faceless guards loses his nerve. The staccato sound of gunfire splits the air. But Johnny is already gone, faded back into a mob that howls like a wounded thing, then surges forward, shattering like surf against armored bodies, lobby doors, massed vehicles, guns. Screams. Gunfire. The strobe flash of the mob tearing a guard apart with vampire teeth, and ripper claws. The sound of a sniper rifle high above the melee, as Santiago methodically picks out guards and blows them away with his Walther WA-2000 rifle. The lobby doors explode inwards as six thousand bodies slam against them.

Rogue is already in—in when Santiago took out the pair of guards by the main doors. She's on the floor and rolling, a fast dazzle bomb palmed over the top of the security desk to fry the optics of the monitor team, followed by a frag grenade a second later. The deafening explosion goes unnoticed in the typhoon roar of the mob. Thompson's right behind her, his video rig and FN-FAL sweeping everything in his path. Both wear armor jacks with the colors of the infamous Iron Sights boostergang, a known Arasaka hit group.

### ADVANCED GOONS

These are Arasaka's front line defense; the guards covering the inside of the Tower. Use an equal number of goons as you have players. At the start of the attack on the Tower, the Arasaka guys will be in the Lobby. Remember; if it get's too hot for your players, use Rogue and Santiago to bail them out.

#### Stats

INT 5 REF 11 CL 5  
 MA 6 BODY 10

#### Cybernetics

One cyberoptic with IR, Targeting scope, Karate chipped to +3, Rippers.

#### Skills

Combat Sense +7, Handgun +7, Brawling +5, Drive +7, Submachinegun +5, Melee +5, Athletics +6.

#### Possessions

Medium Armor Jacket, Light Helmet, Sternmeyer Type 35 Heavy Pistol or Minami 10 submachinegun.

### AKIRA: SUPERGOON FROM HELL

Hmm. Wouldn't it be chill if Alt flubbed the play and Akira was still up and round when the players burst into Toshiro's office. Sure it would. Everyone should have a chance to battle the Hulk from Hell.

#### Stats

INT2 REF 12 CL 3  
MA 8 BODY 12

#### Cybernetics

One cyberoptic with IR, Targeting scope, Body plated.

#### Skills

Combat Sense +9, Handgun +10, Karate +9, Submachinegun +8, Melee +8, Athletics +9.

#### Possessions

Medium Armor Jacket, Minami 10 submachinegun, Bad Attitude.

### LASER DEFENSE SYSTEM

Powered by building current, the laser can hit any point in the room, causing 5D6 damage. It hits on a roll of 7 or higher on 1D10.

There are four lasers, one in each corner, and each has 10 SDP.

Rogue skids around the corner towards the elevator bank, moments ahead of the crowd. Rapidly, she opens each car, spraypaints the monitor lens, punches a destination, then ducks out. The last car in line, she places a shaped charge explosive on the ceiling, wired to a microtransmitter. This one she sends to the twenty-second floor; the executive office suites. Then the rampaging mob hits and carries her along in the swell.

***She's on the floor and rolling, a fast dazzle bomb palmed over the top of the security desk to fry the optics of the monitor team, followed by a frag grenade a second later.***

Thompson is waiting for her by the stairwell. Moments later, Johnny shows up wearing an Arasaka company jacket he's pulled off a guard's body. The name tag reads Harada.

### OPTIONS

Akira turns from the security board. "It has started," he announces. "Instructions, Toshiro-sama?" Toshiro considers. It was a masterstroke for Silverhand to raise a literal army of fans against him. Toshiro is checkmated—Arasaka cannot gun down the crowd with impunity. But he does have options. He turns to Akira. "Send teams to the elevators. Guard the top and bottom of the stairwells, and kill anything in the elevator cars." He looks over at Alt's dormant form. "We have the program," he says. "If we do not have her body, there is no evidence."

Seemingly oblivious, the plugged in Alt permits herself a brief smile. A lot he knows.

Elevators chime open on floors ten, eighteen and five. The fire teams on ten and eighteen throw a hail of lead through the doors. The elevators are empty. The team on five is warned, and opens the doors with greater caution. Empty. "It's a trick!" shouts the team leader. "To the stairwell!"

On floor six, a panting Johnny and Thompson reach the stairwell landing, crack

open the fire doors and scout the hall. They can hear other doors slamming open as the fire teams converge; they bolt for the elevator bank. Prying the doors open, they can see the top of the car on floor five. They drop down to it's top. Thompson hotwires the motor, and they start up.

Rogue can hear running feet behind her. She pauses from her vantage point on floor seven and fires a quick burst down the stairwell. How much time? she thinks. She judges the breathing and the heavy booted tread, and punches six seconds on the timer, then rolls out of the seventh floor fire door. She is halfway down the hall when the first of the charges go off, collapsing the stairwell in on itself and burying the pursuing fire teams. Jamming open the elevator doors with her gun butt, she drops down onto the rising car.

• • •

"Hold her", says Toshiro. Dimly, through the interface, Alt can feel Akira's hands pressing her into the seat. She struggles as the techs strip her plug guards off and hold her wrists. "Can the program be run?" Toshiro demands. His techs nod. Helpless in the grip of the interface, Alt can only sense Toshiro jacking himself into the cyberdeck, giving the command to RUN.

Then her mind is ripped away.

• • •

The elevator streaks upwards, the shaft echoing to either side. They can hear explosions; the sound of running feet, the hammer of machinegun fire. They pass the burned out husks of the cars on floors ten and eighteen. At the twentieth floor, the elevator starts to slow. Just above them, they can see the bottom of the express elevator on the twenty second.

***She is halfway down the hall when the first of the charges go off, collapsing the stairwell in on itself and burying the pursuing fire teams.***

"Duck and cover!" yells Rogue. She taps the transmitter button on her collar and the world blows up.

## ANGEL HEAVEN

She floats naked in a sea of stars. Around her swirls the matrix of Soukkiller, towering into measureless space. Alt reaches out with her enhanced mentality, shaping and forming. A brief flare of thought, and Soukkiller sucks away the minds of her three guardian techs, letting their bodies drop.

From the mind of the head techie, she pulls out the access codes to the mainframe's inner levels. She strips the memory of data, downloading it to her hidden files throughout the Net. Twenty million dollars vanishes from Accounting, to reappear in a subaccount under her name. Pulling Toshiro's signature from his checking account file, she signs his name with a flourish.

Using the access codes, she activates the room monitor. She can see the three techs slumped senseless in their chairs; her own unconscious body limply sprawled across the central console. Akira moves towards it. Alt triggers the room lasers and cuts him in two; his body hits the floor with a steaming thud.

Toshiro's eyes widen in shock, then narrow as he realizes what has happened. "Congratulations, Ms. Cunningham," he says with mock formality. "It seems you have found a way to escape your demise."

"You zaibatsu bastard," she says through the interface, a tiny voice in his ear. "You're going to sit right here with your hands on the table, where I can watch them. You move, and you're laser meat." She tracks the defense system onto him, locking it to fire at the slightest position change. Then she turns back into the Soukkiller construct, wrapping it's power around her, gathering herself to transfer back into her body.

The room staggers; lurches, as five pounds of plastique explosive slams through the ceiling of the elevator, creating an instant fireball. The lasers go wild, spilling a maze of ruby light in every direction. Toshiro throws himself flat, toppling the cyberdeck and breaking Alt's connections. She flails wildly

with the Construct—too little, too late.

Three figures burst into the room, smartguns laying down a pattern of fire though the maelstrom. IR suppressed, enhanced vision on, Johnny spots Alt's still form slumped over a contour couch. He bend down her, taking her in his arms, trembling. Across the room, Rogue looks away.

***Silverhand raises the big black gun. A red pinpoint centers on Toshiro's forehead. "Bang." says Johnny. The Hand convulses. "Bang" says the gun.***

"Well, well, well," says Thompson, striding across the wrecked room towards the corporate head. "What do we have here? Looks like kidnapping and maybe murder. They're going to put you away for a long, long time, Toshiro-chan." His green cyberoptic winks bright as he transmits live and direct to his news net; his head swivels right to left with practiced ease as he subvocalizes the opening to his story; the story he will use to break Arasaka in Night City.

Johnny stares a long time at Alt's almost lifeless body. There is a feeble pulse. But Alt—Alt is gone; lost in the machine; trapped behind crystal. Lost forever. Gone.

He stands away from the couch. "Cut transmission," he says to Thompson. The green cyberoptic goes dark. Silverhand's own eyes are featureless white marbles. The Hand convulses in fury by his side, locking onto the H&K in it's lowslung hip rig. The metal fingers lock to the butt, scrabble-clicking along the parkerized grip.

He just doesn't care anymore. He's dead inside. To hell with it.

Silverhand raises the big black gun. A red pinpoint centers on Toshiro's forehead. "Bang." says Johnny. The Hand convulses.

"Bang" says the gun.

Silverhand turns to gather up her still warm body in his arms. Behind the wall of monitors, a disembodied Alt screams to him.

But he can't hear her as he walks away. ■



*"Of course I work for the Corporations. You think I'm crazy? Look, you have to be realistic. Appraise your options. There's nothing but grunt jobs on the Street. Most of the good jobs out there are managerial; you're bossing a bunch of AIs and robots. To score that kind of work, you need an MBA minimum these days.*

*"So once you've put in six, seven years, you want to maximize that investment. And the Corporation makes that possible. Health care when everyone else is festering on the streetcorner because doctors cost 200 eb an hour. Company sponsored housing, because the average two bedroom home comes in at 500,000.eb. Perks, like an office, a secretary, and a bodyguard.*

*"So of course I'm a Corporate Man. Only an idiot wouldn't be."*

*—Dave Whindam*

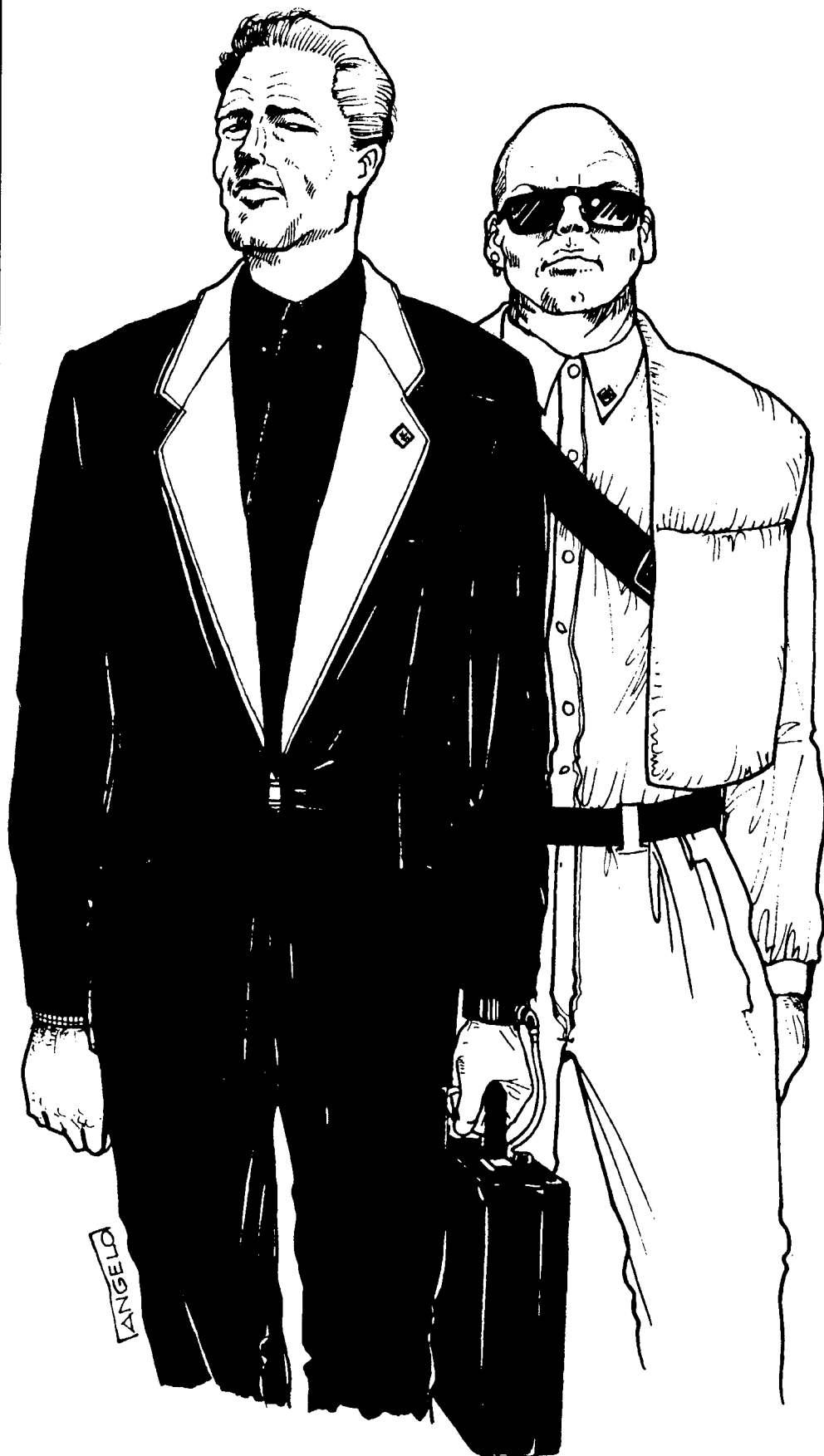

SECTION

14

# MEGACORPS 2020

## Corporate Life

### It's Big Business As Usual in the 2000's

The modern corporations of 2020 are much like the corporations of the late 20th century, only much larger and more fully autonomous. They are very nearly nations in themselves, with their own laws, cities, factories and armies. Most corporations in 2020 are multinational; i.e., they have branches and operations all over the world. These branches may be as small as a research facility or sales office, or as large as a major manufacturing facility and security center.

There are two types of corporations: public and privately held. A public corporation can and does sell stock to the public. The stock is for sale in any of the offices of the World Stock Exchange, and anyone with enough money can buy it. Privately held corporations are more like family businesses. All stock (and thus all power) is concentrated in the hands of a very few—usually partners, relatives, or one extremely powerful individual (Howard Hughes would be a good example).

Most corporations are manufacturers—they produce some kind of commodity for sale on the open market. Oil, steel, automobiles, aircraft, weapons, computers, cybernetics, biotechnologies; these are only a few of the literally millions of corporate operations. Many corporations have several commodities on the market—they may control chemical plants in Europe, computer factories in Japan, and steelmaking operations in the United States.

### Mediacorporations

One type of corporation that deserves special attention is the mediacorp. These huge conglomerates grew out of a trend in the late 1980's, in which certain firms bought up TV networks, film companies, record companies, radio stations, and book, magazine, and even comic publishers; effectively centralizing the media under the control of a very few people.

Entertainment has become generic and bland. Print material has a "sameness" as a hundred magazines are produced by the same company. Dissenting opinions and independent productions are usually buried under an avalanche of media hype, or worse, co-opted or destroyed by the vicious competitive practices of the major mediacorps. Still worse is the effect on news and information. Political candidates have realized that the right connections to the right mediacorp exec can win elections—only a short step to where the media corporations actually select, package and sell their own candidates. While no major government is yet directly controlled by a mediacorporation, most socioanalysts suspect that it is only a matter of time.

### Agricorps

The Age of the Family Farm came to an end somewhere in the 1990s. The United States has always been the world's foremost producer of raw food stock. Coupled with the increasing need for grain and bulk crops to create alcohol fuels and organic plastics, agribusiness became one of the most powerful forces of the post-crash U.S.

*"Most people who don't know anything think being a Corporate is a sellout; you'd lick the bottoms of Ulf Grünwald's shoes for a safe desk and a computer terminal. But you can actually do some good in the Corporate arena, because working for a Corporation gives you a lot of power."*

*"Not all Corps are bad guys. Take my bunch. Last year, we bought up 23,000 acres of Amazon rainforest and set it aside as a bio-preserve. Some people say we did it for selfish reasons; we make biotech animals, and buying up that environment just puts a little more Nature in our pockets."*

*"But I see it another way. That's 23,000 acres that won't be cut down to make furniture. That's a dozen endangered species that will exist somewhere else besides a gene bank..."*

*—Lyle Harrison  
Staff Biologist,  
Biosystems LTD.*

Agricorporations now control (directly or indirectly) nearly 65% of all of the farmland in the United States, feeding roughly a third of the world's population and supplying organic fuels and plastics to nearly two thirds. As the technological world underwent crash conversion from its dwindling petroleum reserves over to advanced forms of methanol, ethanol and meta-alcohol, many of the leading oil producers bought up agricultural lands and shifted their refineries to organic fuel production. As a result, a list of most major agricorps reads like a Who's Who of energy corporations.

### Corporate Powerbrokering

The modern corporation is usually organized as a vast hierarchy, with a President and Board of Directors at the top, and a huge sea of workers at the bottom. In the middle of this, one finds the realm of the corporate executive, a struggling middle class overachiever, usually with the singleminded goal of grabbing as much power and privilege as possible. The average corporate begins as a junior executive, "bossing" a particular project or group of people. At the next level, he becomes a Manager, controlling a specific department or production area. The major infighting begins here—only very successful Managers get elevated to the position of Assistant Vice President, where they control entire factories or other operations. They are, in turn, bossed by Vice Presidents, who control entire divisions of the company. Near the top is the Executive Vice President, who effectively runs the corporation. His boss is the President, who answers only to the Board of Directors (major stockholders) and the Chairman of the Board.

Theoretically, corporate advancement is based on merit. In reality, the corporate world is rife with nepotism, deal making, brown nosing, cheating, lying and credit stealing. Extortion, blackmail and frameups are common.

One of the most disturbing factors in this web of corporate powerbrokering is the role of organized crime. Realizing

in the early '90s that the new megacorps represented an unprecedented new field of opportunity, the powerful families of the Mafia and other crime groups began to offer their services as bodyguards, hitmen, and general corporate enforcers. This pattern had previously been established among the zaibatsu (corporate families) of Japan, who routinely hired both ninja (assassin) and yakuza (gangster) clans for their covert operations. In some cases, the retainers remain faithful—at least to the people who pay the most. In other more unfortunate cases, the hired guns have taken direct control of the corporations themselves, leading to a new age of intercorporate infighting unchecked by even a sham of legality.

### Employment Contracts

In the savage world of Big Business, it's not unusual for an executive to jump from firm to firm, looking for a big success. To prevent this, most Corporations require their employees to sign Employment Contracts, specifying how long they must work for the firm until they can quit. Contracts may run from a year for a low-level executive, to an entire lifetime for a key researcher or company president.

The penalties for breaking Employment contracts are extremely severe; ranging from garnishment of wages, lawsuits, and loss of licenses (in the case of lawyers or physicians). Corporations have also been known to use sabotage software and deadly booby traps to ensure loyalty. Blackmail is common. Assassination and kidnapping are expected.

This makes Corporate "headhunting" (hiring away another company's staff for use by your own company) a deadly game of cat and mouse. Most Corporations have their own "extraction teams" of Solos, who, like the KGB or CIA, arrange "defections" of key personnel from one side to the other. Headhunting can be especially lethal, as most corporations will use any and

all means to stop a rival extraction team.

## Corporations & Governments

Since the Crash of '96, the governments of the world have been in the uncomfortable position of having to let the multinational corporations do pretty much as they please. Paying lip service to pollution control, product safety and minimum wage rules, the modern multinational usually strikes a bargain with the local government. Sometimes this may be as simple as a bribe to the right places, or military support for the local dictator. In the more sophisticated United States, corporations tread lightly, going out of their way to hide their more illegal operations, and making sure to toe the line in their more visible ones. On the local level it's often a case of trading power, influence or money with the right leaders; a judge or police chief here, a senator or congressman there.

One major exception to corporate domination is the Soviet Union. Although interested in acquiring the technologies of the West, the Soviets have successfully kept most corporations from gaining any political foothold within its borders.

Most corporate offices now hold a status roughly equivalent to a national embassy, with employees carrying corporate-issued international passports and identification cards (better, by far, than almost anything national governments can produce). Since the unfortunate *Yasubisu Affair* of 1997 (in which guards of Tokyo-based Arasaka Corp killed 24 French policemen who attempted to storm Arasaka's Paris offices to arrest an executive charged with rape), most corporate foreign branches maintain a policy of shipping criminal employees back to the company's home office. Company negotiators then arrange

to extradite the felon back to the nation where the crime took place.

## The World Stock Exchange

The modern corporation rests on its stock. Stock is essentially a “share” in the company’s assets, which can be traded and sold much like property cards in Monopoly. Corporations sell stock to outsiders in exchange for hard cash, which the corporation can then use to finance its activities. As a stockholder, you are gambling that the stock you hold (which is a percentage of the total value of the company) will increase in value as the company’s assets increase in value. For example, if in 1975, Cyber Computer was worth a grand total of \$100.00, and you owned 20% of this, your stock would be worth \$20.00. Eight years later, when Cyber is worth two million dollars, that same 20% is now worth \$400,000.00! On the other hand, if Cyber goes bust, that stock is worth nothing.

The more stock you have, the more control you have over the assets and activities of the corporation. One reason for this is that each share you hold is equal to a vote concerning what is done with the company. As a general rule, if you own more than 50 percent of the stock of a corporation, you have the majority vote. This vote can be used to fire or choose the leadership of the corporation, direct corporate decisions, and even force the corporation to merge with another company.

The basic form of corporate stock holding is little changed from the early stock exchanges (places where people go to buy, sell or trade stock in companies) of the 20th century. What has changed is the scale of operations. The stock exchanges of London, Tokyo, New York and other major cities were merged into a gigantic World Stock Exchange late in the 1990’s. A generic exchange rate (known as the Eurodollar) had been

established, and a system of trading imposed over the various subexchanges worldwide.

While there are stockbrokerages all over the world, the major Exchange offices are located in London, Paris, Zurich, Tokyo, New York, Cairo, Rome and San Francisco. However, with the creation of the Net—the vast web of communications that blankets the planet—the ability to buy, sell and trade shares has been extended to almost anyone. Investors can now use their phone nets to contact their brokers at any time or from any place, even the remotest jungles. Never before has the business of making millions on the “market” been so universal. And never before has the Market been balanced on such a razor’s edge between incredible wealth and worldwide economic disaster.

## Corporate Espionage & Covert Activity

In the 2000’s, almost every corporation employs at least one force of highly trained covert operatives, specializing in espionage, counter-espionage, sabotage, and counter-terrorism. In extreme cases, measures such as assassination and terrorism are not unknown, whether against other corporations or within the corporate structure itself.

This is not an entirely new phenomenon. For many years, the powerful Japanese industrial combines, or *zaibatsu*, were known to secretly employ ninja clans in many of their covert operations. These connections stretched back into the distant past, when many of the same clans served the feudal ancestors of the *zaibatsu* rulers. Less covert operations requiring muscle and a lack of subtlety were often delegated to various Japanese gangster mobs, many of whom had full or partial interests in the corporations themselves. As Western corporations

began to adopt various methods of Japanese management and production, it was a simple step for these companies to adopt or create their own “ninja” forces. This historical reference may be one reason why hired corporate killers and spies are known on the street by colorful terms such as *ninja*, *samurai*, *ronin* and *yakuza*.

A corporate covert operations arm usually is made up of weapons specialists, computer technicians, and various “hired guns”. Almost all of these covert forces are cyberenhanced with the best technology available. Covert action arms frequently search the deadzones and arcologies for promising young criminals to recruit, promising them high pay, the best enhancements, and a life of glamor and adventure.

## Corporate Wars

While most aspects of corporate competition remain on the economic level, there are instances where it moves into the arena of actual warfare. While these are not declared wars, per-se, they have all the aspects of the real thing, as missiles, armored vehicles, jet aircraft and cyberenhanced ground troops are brought into play.

By its very nature, a corporate war must be covert—very few nations are willing to allow two companies to “duke it out” on their soil. Early on, most corporations hired actual terrorist groups to strike at enemy targets. As these groups became more undependable, the companies began to actually create battle forces disguised to resemble terrorists. Many terrorist groups such as the infamous *Red Flag Army* and the *New Aryan Sons* are actually fully equipped corporate strike forces, whose seemingly random attacks on rival offices and strongholds are part of larger covert warfare actions.

A corporate war never lasts longer than necessary—if combat activity becomes noticeable, there is too great a chance of government intervention. While no corporate army is yet powerful enough

to challenge a major government directly, there are already reports of smaller nations who have capitulated to the power of the business armies.

## The Corporate City

In the 1960's thru '70s, social unrest and upheaval tore through the central cities of America, leaving burned out tenements, deserted factories, and dying businesses in it's wake. Most major corporations soon moved their operations to safer suburban business parks and malls.

But as real estate prices began to rise, and the suburbs became more crowded, the major companies began to reconsider their strategies. By the middle 1980's, corporations working with city governments began to rehabilitate the inner city. The corporations provided the money for new buildings, shopping malls and model community areas, while the government provided tax incentives, inexpensive land, and police protection. By 1989, many inner city areas across the U.S. including New York, San Francisco, Baltimore and Boston had undergone this "gentrification" process.

The human cost of this restructuring was the displacement of the "undesirables" of the urban dead zone. Poor, drug dealers, pimps, gangs and streetpeople were all pushed out from the city center, creating a region bounded on one side by affluent suburbs and on the other by the now showcase central city. This "doughnut" effect had a further impact on the community—by shoving the dead zone inhabitants between the two areas, crime rates on both sides of the line began to skyrocket. Street gangs routinely shuttled between the middle class suburbs and the model inner city to prey on new victims.

By the mid 80's, corporations routinely hired guard patrols to supplement already overloaded city police forces.

These corporate police were well paid and had access to the best equipment available. As police services began to collapse throughout the U.S., many cities took to hiring corporate forces outright, deputizing them and turning city law enforcement over to them.

The corporations were equal to the task. Ruthlessly, they equipped their teams with the best weapons and armor. When an arrest was made, they made the best use of their considerable legal talent and influence to ensure the severest penalties. When an arrest wasn't possible, they often resorted to the harshest of policies. Entire gangs would be decimated in a single night by heavy weapons teams and armored vehicles. The bodies would summarily end up in the landfill, and the legal staff would quietly arrange to cover the incident over.

In the 2000's, the corporations usually control both the inner city and a large portion of the company owned suburban developments outside of the city. To facilitate their commuters, many of the megacorps have installed light rail and underground systems between the showcase inner city and the well-protected suburbs. Patrolled by corporate guards, monitored by cameras and the most sophisticated sensors, these railways are always clean, quiet and ominously crime free.

### Corporate Suburbia

By 1990, a two bedroom house cost a median \$200,000.00; more than most families could hope to raise. As the corporations fought for skilled employees, they realized that an affordable home could easily become one of the many fringe benefits to offer a prospective worker. Soon, in the U.S. and abroad, corporations began



building or buying large tracts of housing, which were then offered at drastically reduced prices to company members.

A further stage of development was reached in 1995, when, in the historic *Tennicorp vs Davis* decision, the Supreme Court ruled that while a corporation could not restrict housing sales on the basis of race, creed or color, it did have the right to offer housing to its employees on a preferential basis. As a result, most areas of corporate suburbia are routinely comprised of upper middle-class execs and their families. While made up of widely varying races, religions and nationalities, all corporate communities share a common origin—the Company.



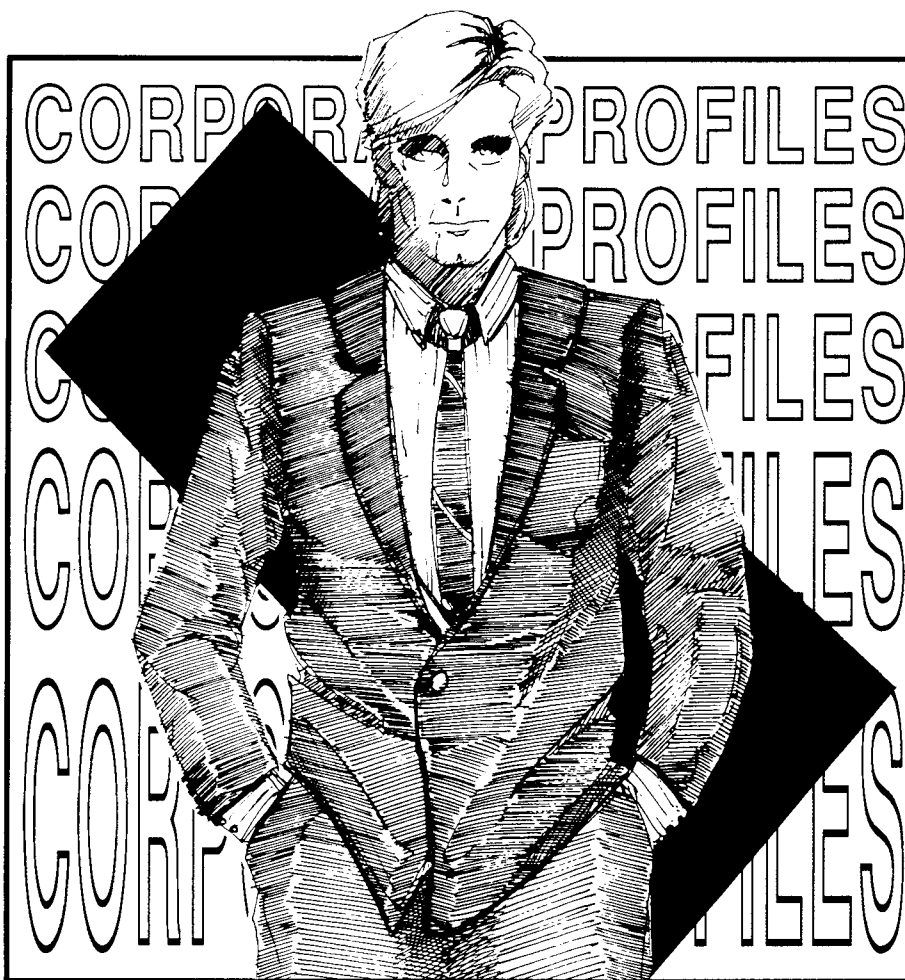

## Corporate Profiles

The following report contains essential information and breakdowns on some of the 21st century's most prominent and powerful corporations. These profiles are intended to be used by the Referee as guidelines, not as inflexible parameters.

Head Office is the location of the firm's board of directors, usually, but not always, the largest and most important executive facility the corporation has. Offices are other manufacturing or executive sites owned by the corporation. Listed sites are major offices. A corporation may have small bureaus worldwide.

Stock is the total number of shares in existence for that corporation. Listed in

each profile is the name and location of residence of that company's major shareholder. This is the single person who wields the true power behind the company. Any person or organization (such as the board of directors) which holds over 50% of the total stock wields ultimate control over the corporation. Open Shares are the shares currently up for sale on the World Stock Exchange. Usually in the neighborhood of ten percent.

Troops represent the combined number of combat soldiers available to the corporation. Usually, troops are spread among the offices of the corporation, with heavier numbers stationed at potential trouble sites or high security compounds. Covert Operatives are

industrial and political espionage agents and covert combat Operatives. Among other things, troops and covert operatives are used in the dangerous field of corporate extractions, removing valuable personnel from one corporation to another, either by defection or force.

Equipment and resources are the vehicles, technology and weapons owned by the corporation, as well as equipment it can commandeer or procure from other sources, such as governments, in an emergency. Most corporations own private helicopters and jets which can be retrofitted for rapid deployment and combat use, as well as dedicated military vehicles...commonly the AV-4 urban assault vehicle and the Osprey II V-TOL aircraft. The Osprey II is also used as a corporate transport in high-security situations. Large companies maintain a private airlift capability, usually using the Boeing C-25 heavy cargo aircraft. The C-25 can haul six AV-4s, two dismantled Osprey IIs, three tanks, or five hundred troops depending on how it is fitted. Combination loads are also possible due to the aircraft's modular interior design. It can be assumed that such things as armored limosines and high-tech site security are standard.

Some corporations have small orbital workstations for specialized zero-g production and research. These workstations consist of a number of pressurized "shacks" with no gravity of their own. The shacks are anchored together by a flexible structural framework that also supports power and life-support pods, and are normally staffed by a few dozen people and a small contingent of space troops. These stations also maintain weapons systems to repel attack from rival corporations if necessary. Workstations each have a few small pressurized and unpressurized service and transport vehicles. All corporations, with the exception of the Orbital Air Corporation rely on government lifting vehicles or Orbital Air to shuttle products and personnel to and from orbit.

### EUROBUSINESS MACHINES CORPORATION

*Multi-role computer and electronics manufacturer.*

- **Headquarters:** Hamburg.
  - **Regional Offices:** W. Berlin, Rome, Madrid, Paris, Stockholm, Geneva, Oslo, Helsinki, London, Tokyo, Cairo, Jerusalem, Los Angeles, San Francisco, Washington, Chicago, Dallas, New York, Hong Kong.
  - **Name and Location of Major Shareholder:** Dr. Rudolf Muller, Bremen, Germany, holding 20.8% of total shares.
  - **Employees:**
- | Worldwide | Troops | Covert |
|-----------|--------|--------|
| 1,000,000 | 20,000 | 2000   |

**Background:** In the late 1990's, EBM, already the largest computer and high-tech manufacturer in the world, and one of the most significant corporations in existence, pulled off the greatest free-market hostile takeover in history. Led by master corporate raider Dr. Kurt Muller, this maneuver caused the merger of EBM with many other prominent computer companies around the world, consolidating EBM's already fearsome market power. Currently, Muller, and his two partners in the triumvirate, Ulf Grunwalder of Munich and Sir Nathaniel Poole of London, comprise the majority vote of EBM, holding 52.1% between the three of them. Their long-term goal is to consolidate as much of the world's high-tech manufacturing as possible under their label by any means.

**Equipment and Resources:** Dispersed among the EBM offices as dictated by need are forty-six AV-4s, twenty Osprey II V-TOL attack craft, twenty corporate jets for the use of the executive board and five heavy cargo planes. In addition, each office has two helicopters and a fully staffed clinic and infirmary. EBM's power and stature gives it access to the highest levels of military technology. EBM also has a top secret underground medical and research/training facility hidden in the Alps. EBM maintains a small orbital research facility with about thirty researchers and ten soldiers.

### ZETATECH

*Wetware and computer hardware and software design.*

- **Headquarters:** Cupertino, California. (Silicon Valley).
  - **Regional Offices:** San Francisco, San Jose.
  - **Name and Location of Major Shareholder:** Bob Rosemont, New York, holding 58.8% of total shares.
  - **Employees:**
- | Worldwide | Troops | Covert |
|-----------|--------|--------|
| 12,000    | 150    | 12     |

**Background:** Zetatech is a typical up-and-coming high-tech company doing its best to grow and diversify. It has carved itself a small niche in the industry through the traditional methods: quality products, industrial espionage, and strategically applied violence. Having made it over the first hurdle, Zetatech is attempting to build a heavy name for itself by expanding overseas, the assured way toward success, and a high inflow of stable Eurodollars. This means encroaching on markets occupied by other companies, most of which are not inclined to share their profits. Zetatech's position as an established, growing, but small and relatively weak company make it a prime target for hostile takeover, and they must be continually on guard.

**Equipment and Resources:** Three AV-4 assault vehicles, three helicopters, one private jet based out of San Francisco International Airport. Each office has an emergency first aid infirmary, but only the San Francisco office has a surgery capable trauma center. The military hardware available to Zetatech is only of moderate power. High-tech personal arms, armor and vehicular weapons systems are readily available, but only limited amounts of heavier weapons are available, and usually they can not be obtained on short notice. Zetatech has no airlift capability of its own, but could arrange access to heavy lifting aircraft given enough time.

### network news 54

*Nationwide broadcasting service.*

- **Headquarters:** New York.
  - **Regional offices:** Atlanta, Chicago, New Orleans, Dallas, Indianapolis, Denver, Arizona, Portland, Seattle, Los Angeles, San Francisco, Detroit, Washington, with subsidiary stations in most major cities.
  - **Name and Location of Major Shareholder:** Edwin R. Dreyer Foundation, under control of Michelle Dreyer. Located at Fifty Pines Ranch, near Santa Fe, New Mexico. The estate controls 27.9% of all shares.
  - **Employees:**
- | Worldwide | Troops | Covert |
|-----------|--------|--------|
| 78,000    | 5,000  | 750    |

**Background:** Network News 54 is a wavelength monopolizer, operating on the same frequency across the country. Accordingly, no matter where you go in the country, Network News 54 is on Channel 54. Despite its name, News 54 offers many diversions in addition to news. Every regional office offers a slightly different schedule to its district, with syndicated series, non prime-time movies, independent local news programs. Certain elements of the broadcasting are universal nationwide, such as prime-time series and bi-hourly national and world news shows.

**Equipment and Resources:** Network News 54 owns 42 AV-4s, ostensibly used as mobile news gathering and broadcasting facilities. These vehicles also retain much of their combat function. News 54 also owns 30 helicopters for weather and traffic reporting at each of the network offices, as well as for shuttling company executives, and ten corporate jets and five Osprey II aircraft. The network has standard personal equipment for its troops, but little access to military weapons of a non man-portable nature, with the exception of a few vehicles. News 54 has no airlift capability of its own.

### Orbital Air



**Cargo and passenger transport to Earth orbit, and maintenance of commercial orbital facilities.**

- **Headquarters:** Nairobi, Kenya.
  - **Regional Offices:** Anchorage, Vancouver, Montreal, New York, Washington, Miami, Houston, St. Louis, Chicago, Denver, Portland, San Francisco, Los Angeles, Mexico City, Rio De Janiero, London, Paris, Madrid, Cairo, Sydney, Singapore, Tokyo, Honolulu and the Johnson Orbital Facility in low Earth orbit.
  - **Name and Location of Major Shareholder:** Antoine DuBois, Paris, holding 15.2% of total shares.
  - **Employees:**
- | Worldwide | Troops | Covert |
|-----------|--------|--------|
| 104,000   | 10,043 | 700    |

**Background:** Orbital Air holds a key position in the twenty-first century; with their large fleet of French-made Hermes space-planes they monopolize all orbital lifting capability, with the exception of a few governments, none of which offers comparable service. Many corporations rely on Orbital Air for transport of cargo out of the gravity well. The Euro-Space Agency's Crystal Tower L-5 colony, a massive orbital hotel complex for the ultra-rich, would be out of business without them. With all commercial space bound cargo dependent upon them, Orbital Air is in a lucrative position that it would like very much to maintain. A large part of OA's budget and covert resources is put to use ensuring that they remain the leader in orbital technology, and that the competition does not make it off the ground, literally or figuratively. Currently, their eye is on China, which is improving its commercial lift capability rapidly. Also, Euro-flight Corporation is expanding its operations, and expecting to bring orbital services on line soon. This has OA worried about its monopoly. The Johnson Orbital Facility is a transfer station for passengers bound for the Crystal Tower, where they switch from the space-planes to space transport shuttles

assembled at the OA orbital workstations, or purchased from the Euro-Space Agency.

**Equipment and Resources:** 35 orbit capable Hermes Scramjet space-planes, 35 corporate jets, two helicopters per office, 70 AV-4 urban assault vehicles, 15 Boeing C-25 heavy cargo jets, and 30 Osprey II V-TOL aircraft. All major offices have surgery capable infirmaries. Orbital Air is well equipped, and has access to almost all levels of military equipment. It is primarily interested in space defense and air-superiority weaponry to protect its orbital and airborne resources. In addition to the Johnson Facility, Orbital Air maintains two small maintenance and research workstations, and has a small fleet of orbital vehicles to transport crews between the facilities.



### Microtech

**Ultra-sophisticated mainframes and workstations.**

- **Headquarters:** Dallas, Texas.
  - **Regional Offices:** Sunnyvale, California, Miami, London, Tokyo.
  - **Name and Location of Major Shareholder:** Stephen Lew and family, San Francisco, holding 55.5% of total shares.
  - **Employees:**
- | Worldwide | Troops | Covert |
|-----------|--------|--------|
| 52,340    | 1,000  | 52     |

**Background:** Microtech does one thing, and they do it well: build full-size computers. They concentrate all of their efforts into improving their mainframe computer systems, without dabbling in cybernetic computers or mini-computers. Indeed, they take pride in the fact that their mainframes and workstations are used by other companies to design those types of systems. They are to the 2000's what Cray was to the 1980's and '90's, but on a larger scale. Microtech is the industry standard. Defense agencies around the world rely on Microtech mainframes, and the Euro-Space Agency has several. With its hold on the specialized mainframe industry, Mi-

crotech is worried not so much about acquiring proprietary data through espionage as protecting itself against such theft. This is where most of its covert and military resources go, as well as a sizable amount of its own computer power. Microtech must be vigilant for external threat as well, however, as there are several larger corporations who would like to acquire Microtech, or see it eliminated in order to further the success of their own products. Accordingly, Microtech is attempting to beef up both its financial and military security.

**Equipment and Resources:** Six AV-4 assault vehicles, ten helicopters, two Osprey IIs and three corporate jets are dispersed among the offices. Microtech has access to sophisticated military hardware on a fairly small scale, with good amounts of personal weaponry and armor, including man-portable heavy weapons. It has no heavy, mobile armored vehicles (such as tanks), and only limited access to other vehicular based heavy weapons. With sufficient time, however, Microtech can usually acquire whatever equipment it needs. Only the Dallas office has a surgery-capable medical center, but all of the other offices have well staffed infirmaries capable of dealing with most non intensive care needs, including trauma and illness. Microtech has no orbital platform of its own, but it occasionally ships experiments up by Hermes space-plane if zero gravity is required.

### Biotechnica

*Genetic engineering, microbiological and biochemical research.*

- **Headquarters:** Rome.
  - **Regional Offices:** London, Bonn, Paris, and La Jolla California.
  - **Name and Location of Major Shareholder:** Nicolo Loggaglia, Monte Carlo, Monaco, holding 13.8% of total shares.
  - **Employees:**
- | Worldwide | Troops | Covert |
|-----------|--------|--------|
| 36,256    | 1,833  | 124    |

**Background:** When the fuel crisis really began to affect the industrialized community in the late 1990s, Biotechnica, then a small firm with only one office, came up with the answer: CHOOH2™ (pronounced 'chew two'). CHOOH2™ (not its actual chemical formula) is a complex grain alcohol produced by genetically engineered yeasts and wheat strains created by Biotechnica. The potential of CHOOH2™ was realized almost immediately after it was introduced, and within a few years all fuel burning vehicles and power plants had converted to the new fuel. Although Biotechnica held worldwide patents, it lacked the production facilities to meet worldwide demand, forcing it to license production to several large agribusinesses and petro-corporations. These deals made Biotechnica an extremely wealthy, but still not particularly large, company. It is currently expanding, and working on its next big biotechnical breakthrough.

**Equipment and Resources:** Biotechnica has ten AV-4 assault vehicles, five corporate jets, three Osprey II aircraft and one Boeing C-25 heavy cargo jet, moved as needed among its offices. In addition, each office maintains two helicopters and a surgery capable infirmary. Due to the worldwide importance of its developments, Biotechnica has a fair amount of power in the political community, and it can usually obtain whatever military equipment it needs, although some items may take more time to procure than others. Biotechnica has one orbital research workstation.

### INFOCOMP

*Corporate think-tank and information brokers.*

- **Headquarters:** Los Angeles.
  - **Regional Offices:** San Francisco, New York, Washington, Chicago, Denver, Vancouver, London, Honolulu.
  - **Name and Location of Major Shareholder:** Robert D. (Bob) Alvarez, Kapaa, Kauai holding 19.2% of total shares.
  - **Employees:**
- | Worldwide | Troops | Covert |
|-----------|--------|--------|
| 9,352     | 400    | 34     |

**Background:** Infocomp provides scientific, technical and personal data pertaining to any subject to anyone who can afford to pay for it. The ultimate detectives, they pride themselves on their elite scientific and research staff's ability to unearth, cogitate, formulate and theorize. For the right price, clients can access Infocomp's huge library of existing information, or have them provide information pertaining to a subject not yet explored. Watch out—the tougher the problem, the higher the bill. . . .

**Equipment and Resources:** Each office has a surgery capable infirmary, an Osprey II aircraft, a private jet, two helicopters, two AV-4 urban assault vehicles, several Microtech Corp. advanced mainframes and an extensive library and information gathering network.

### MERRILL, ASUKAGA & FINCH

*Exclusive investment and financial counseling firm.*

- **Headquarters:** New York.
  - **Regional Offices:** San Francisco, Los Angeles, Chicago, Hong Kong, Tokyo, London, Paris, Munich, Rome.
  - **Name and Location of Major Shareholder:** Howard Merrill, New York, holding 22.0% of total shares.
  - **Employees:**
- | Worldwide | Troops | Covert |
|-----------|--------|--------|
| 21,926    | 100    | 10     |

**Background:** If you have money, and you want more, or you just want it safe, *Merrill, Asukaga, and Finch* are the people to talk to. They are without a doubt the top people in investments of all kinds, from stock to real estate to frog-farming futures. However, if you don't have a good deal of money in the first place, they aren't interested—the commission on a \$1000 investment isn't worth their rather expensive time. MA & F's high caliber of service has attracted many of the richest and most powerful people in the world. If, for some reason, they were to go bankrupt, some of the greatest powers in the world, both legal and illegal, would be overturned.

**Equipment and Resources:** Dispersed as needed among the offices are 15 AV-4 assault vehicles, eight corporate jets, and two Osprey II aircraft. Each office also has two helicopters and a non-surgical infirmary. *Merrill Asukaga & Finch* controls the finances of many powerful people, and even some small nations. Accordingly, they can command a great deal at short notice, including political favors and powerful military equipment.



### WNS World News Service™

*Worldwide news service.*

- **Headquarters:** London.
- **Regional Offices:** Anchorage, Seattle, Ottawa, New York, Washington, Miami, Dallas, St. Louis, Chicago, Denver, Portland, San Francisco, Los Angeles, Phoenix, Mexico City, Caracas, Rio De Janiero, Oslo, Stockholm, Helsinki, London, Berlin, Jerusalem, Cairo, Tokyo, Honolulu, Tangier, Beijing, Shanghai, Crystal Tower.

• **Name and Location of Major Shareholder:** Mahmet Al Hamedi, Riyadh, holding 31.6% of total shares.

• **Employees:**

Worldwide	Troops	Covert
215,000	7,005	644

**Background:** WNS keeps tabs on the world, by any means possible. Newspapers and news stations around the world pay large amounts of money to receive WNS stories via the WorldSat Network. WNS has more offices than most corporations, but most of these offices are fairly small and limited in function, intended to serve only as bases of operations for the Operatives and reporters working in an area. WNS has at least a small office in almost every major city in the world, but these are sometimes no more than rooms with a few provisions, one resident agent and a Telecom-Terminal linked to the nearest regional office. Few competitors can match WNS' information gathering capabilities, and WNS ensures that it remains at the forefront, not only through legitimate means, but also through spying, espionage, sabotage and illegal snooping of all sorts. WNS does not run any stations of its own, choosing instead to broker its information to the highest bidder. There is no shortage of buyers, as ratings-hungry broadcasters will fork over millions for exclusive rights to an especially juicy story and the included multi-media presentation package containing WNS' videos, write-ups and commentaries.

**Equipment and Resources:** Dispersed among the regional offices as needed are

65 AV-4 urban assault vehicles, twenty-five Osprey II aircraft, twenty-five corporate jets, and five Boeing C-25 heavy cargo aircraft. Each regional office has two helicopters and an infirmary. Only the London, Los Angeles, New York, Paris, Tokyo and Seoul offices have surgical capability. WNS has access to moderate levels of military technology, including personal armor and weapons, light vehicles and aircraft.

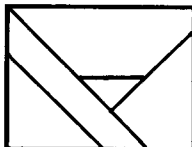

### PETROCHEM

*Petrochemical products and agribusiness. Worlds' largest CHOOH<sup>2</sup> producer.*

- **Headquarters:** Dallas, Texas.
- **Regional Offices:** New York, Washington, Miami, Chicago, San Francisco, Tokyo, London, Hamburg, Hong Kong, Paris, Rome. Oil fields in Canada, Texas, Alaska, California and Antarctica. Agricultural areas in California and the Midwest and Southeast.

• **Name and Location of major shareholder:** Ellen Trieste, Crystal Tower orbital facility, holding 23.7% of total shares.

• **Employees:**

Worldwide	Troops	Covert
338,000	30,000	2,500

**Background:** Petrochem Industries keeps the world running, literally. They are the world's largest producer of CHOOH<sub>2</sub>, and control millions of acres of arable land across the United States. This land is used to grow the genetically altered wheat that is used to make CHOOH<sub>2</sub>. (Surplus grain is shipped across the world as food.) Petrochem is also one of the largest remaining oil producers. With the oil supply dwindling, all remaining fossil fuels are used to make plastics and other synthetics. Petrochem has more fertile oilfields than any other company. All of these assets are huge, and accordingly hard to protect from other companies that would like to usurp Petrochem's wealth. As a result, Petrochem invests huge amounts

of money in protecting itself, maintaining an armed force worthy of a small country. Currently, all of the major petrochemical corporations are in a research race to come up with a viable artificial plastic base to entirely replace petroleum products. Consequently, industrial espionage is rife in the industry.

**Equipment and Resources:** Petrochem has vast interests to protect, and is thus fiercely armed. Dispersed among their major offices, oil fields and agricultural areas are 150 AV-4s, forty Osprey II aircraft, ten Boeing C-25 heavy cargo jets and fifteen corporate jets. Each office has three helicopters and a surgery capable infirmary. Petrochem has considerable access to the highest levels of military technology, due to their national and worldwide importance. They also have a large orbital research facility that is well protected, physically and electronically.



### TRAUMA TEAM INTERNATIONAL

*Ambulance and paramedical services*

- **Headquarters:** Los Angeles.
  - **Regional Offices:** World wide in all major Cities
  - **Name and Location of Major Shareholder:** Carrie Lachanan of San Antonio, Texas, holding 33.3% of total shares.
  - **Employees:**
- | Worldwide | Troops | Covert |
|-----------|--------|--------|
| 16,526    | 350    | 25     |

**Background:** As one of the largest private medical firms in the world, Trauma Team provides ambulance services and paramedical support for a client base of at least fifteen million people. Equipped with top line AV type vehicles, Trauma Teams provide an essential service in the 2000's—recovering wounded clients from the field.

**Equipment and Resources:** Dispersed as needed among the offices are 1,305 AV-4 aerodyne vehicles, thirty corporate jets, twenty two Osprey II aircraft and four Boeing C-25 heavy cargo jets. Each office also has it's own surgical-capable infirmary.





**WorldSat  
Communications  
Network**

*Satellite transmission and communications.*

- **Headquarters:** Paris.
- **Regional Offices:** London, Rome, Madrid, Stockholm, Bonn, Cairo, Nairobi, Brasilia, Washington, Los Angeles, Toronto, Tokyo, Beijing, Hong Kong.
- **Name and Location of Major Shareholder:** Raymond Rousseau, Menton, French Riviera, holding 15.5% of total shares.

• **Employees:**

Worldwide	Troops	Covert
51,625	7,444	658

**Background:** WorldSat has the monopoly on large-scale satellite communications, and is responsible for the transmission of phone, military, computer and commercial data. These communications are crucial worldwide, and their disruption could be disastrous. WorldSat invests a great deal in making sure this does not happen. The satellites are even shielded against electro-magnetic pulse, although no one is really sure how well this will work. Although it is illegal, it is also possible for WorldSat to monitor any of the communications it is transmitting.

**Equipment and Resources:** Dispersed among the offices are thirty AV-4 assault vehicles, twelve Osprey II aircraft, five corporate jets and three Boeing C-25 heavy cargo jets. Each office also has two helicopters and a surgical infirmary. World Sat's satellites are crucial to many nation's communications. Consequently, most high-tech military hardware is available to them on short notice. WorldSat has a large, well protected orbital service facility.

## ARASAKA

*Corporate security, corporate police and various corporate suboperations.*

- **Headquarters:** Tokyo.
- **Regional Offices:** Singapore, Hong Kong, Osaka, Kyoto, Bangkok, Baghdad, Sydney, London, Hamburg, Paris, Madrid, Rome, Geneva, Helsinki, The Hague, Rio de Janeiro, Montreal, New York, Washington, San Francisco, Los Angeles, Chicago, Honolulu. Suboffices throughout the world.

• **Name and Location of Major Shareholder:** Saburo Arasaka, Tokyo, holding 19.9% of total shares.

• **Employees:**

Worldwide	Troops	Covert
1,000,000	100,000	5,000

**Background:** If you want it protected, these are the people to speak to. They maintain the largest armed force of any corporation, although they do not maintain a particularly large amount of on-hand military heavy weapons. These troops are mostly licensed out to other firms as corporate security guards, couriers and mercenaries. They are the best trained and hardest in the business, and will follow their client's orders second only to Arasaka's. To the Arasaka corporation, they are loyal to the point of death. Arasaka is more interested in fostering its own political goals than protecting other companies, and they use their position of trust with major corporations around the world to gain inside information, contacts and advantages that will help them to realize their ultimate goal of political and economic control of Japan.

**Equipment and Resources:** Dispersed among Arasaka's offices are 250 AV-4 assault vehicles, 250 Osprey II aircraft, eleven corporate jets and twenty Boeing C-25 heavy cargo jets. Each office also has two helicopters, and a surgical infirmary. Arasaka's wealth gives it access to almost all levels of military technology on fairly short notice. Arasaka has a secret training facility in Hokkaido, where it trains its security troops and Operatives.

## MILITECH

*Arms manufacturing and distribution, mercenaries.*

- **Headquarters:** Washington D.C.
- **Regional Offices:** New York, Miami, Chicago, Montreal, London, Rome, Zurich, Night City, Washington, Los Angeles, Toronto, Tokyo, Beijing, Hong Kong.
- **Name and Location of Major Shareholder:** Gen. Donald Lundee, USMC (ret.), Annapolis, Maryland, holding 13.9% of total shares.

• **Employees:**

Worldwide	Troops	Covert
350,000	100,000	2,031

**Equipment and Resources:** Dispersed among its offices and mercenary forces as needed are 200 AV-4 urban assault vehicles, 150 Osprey II aircraft, twenty corporate jets and twenty Boeing C-25 heavy cargo aircraft. (Usually, 50-75% of this equipment is in the field at any given time.) Additionally, each office has two helicopters, and a surgical infirmary. Naturally, MTI has access to large amounts of the best military technology available. MTI maintains secret training camps in Texas, the Sierra-Nevada Mountains of California, and Florida.

**Background:** MTI is the world's largest producer and seller of military weapons of all kinds. From revolvers to tanks to jet fighters, MTI is a major military supplier to the United States, and the United States, in turn, is MTI's largest customer. MTI will deal worldwide with anyone who has money. MTI's mercenary forces and in-house supply of weaponry make it the most militarily powerful company in the world, if not the most economically. That will come later. . . .

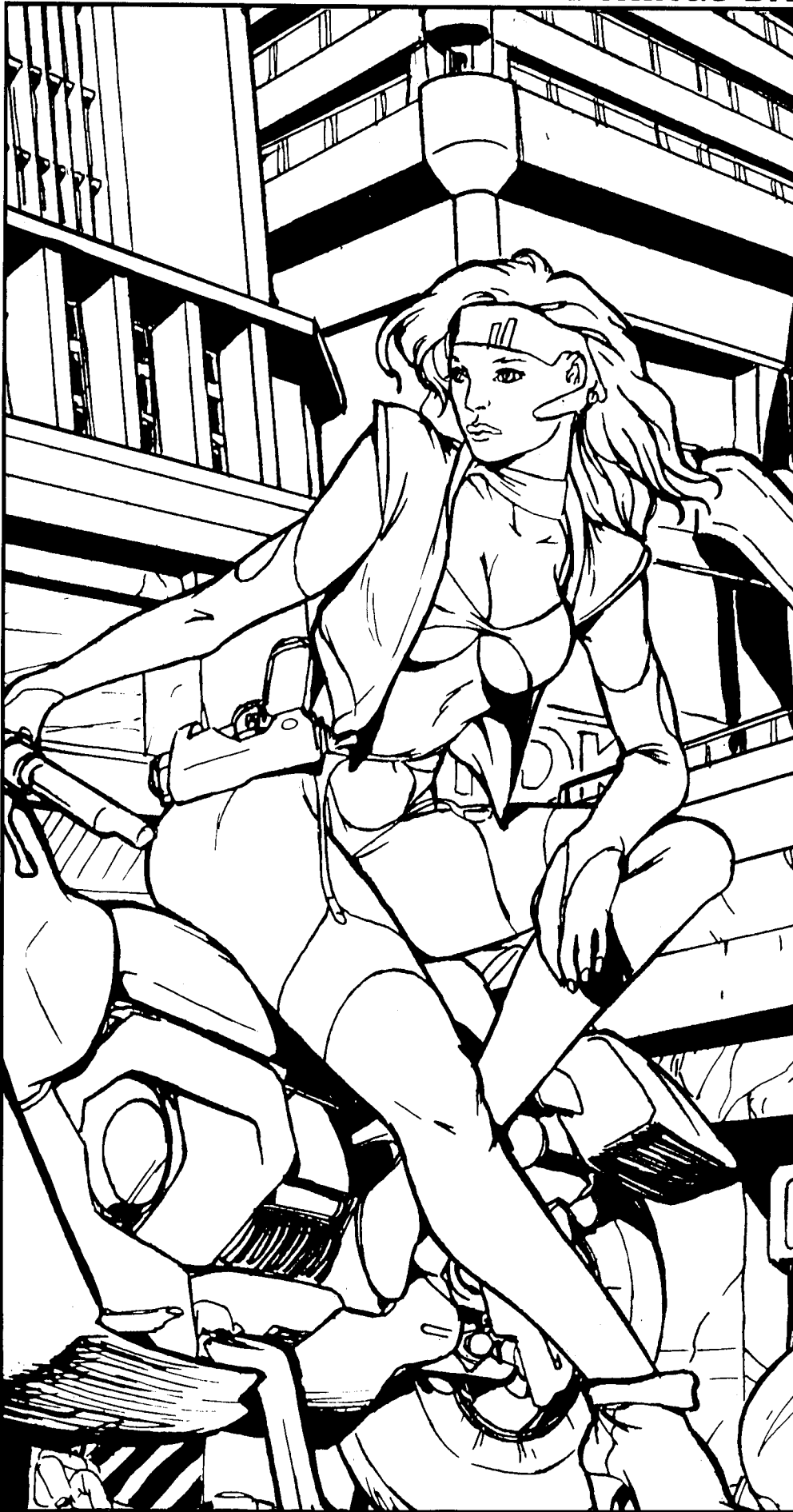

**"I love this place.  
On the other  
hand, I've also  
been accused of  
being a  
masochist."**

**—Johnny Silverhand**

**"Nobody ever  
leaves Night City.  
Except in a body  
bag."**

**—Bes Isis**

**"The City of the  
Fallen Angels.  
Not to mention  
the Legion, the  
Chromers, the  
Gilligans, the  
Inquisitors..."**

**—Lt. Strawberry  
Morressey  
NCPD**

**"Night  
City...Ahwoooo!"**

**—Unknown**

### WELCOME TO NIGHT CITY

Night City is a modern urban environment, complete with dark streets, filthy alleys and rowdy clubs. Where is it located? What's its real name? Not important. Night City is any big city in the world—it could be yours—late night and up against the wall.

The important thing about Night City is the feel, not the substance. It should be a place that the Referee has an immediate grasp of, allowing him to give his descriptions the proper "you are there" ambience. Night City plays best when you use a city that the players are somewhat familiar with; the recognition of street names and places juxtaposed with Boostergangs and hovering assault vehicles will make the 21st century even stranger than fiction.

But we realize some of you don't live in a major urban area. For those of you who can't just use a map of your home town, here's our own Night City to begin your adventures in.

# SECTION 15 NIGHT CITY

## Night City: The Overview

**Name:** Night City

**Founded:** 1994

**Population:** 5,000,000

**Businesses:** Technical, light industry, trade, electronics.

### Background

Night City is a moderately-sized city located on the west coast of the United States. It has a population of about five million in the Greater Night City Area, with the majority living in sprawling suburbs to the southwest. The city itself lies on a large bay, surrounded by several small subcities and suburban communities (Westbrook, Heywood, Pacifica, South Night City).

Years of pollution, neglect and one of the most corrupt governments in the world have reduced most of these cities to cluttered, semi-deserted sprawls, with burned out homes, empty shopping malls and rampant street crime.

### History

Night City was founded rather recently as cities go. Before 1994, the city was merely a clutter of unincorporated suburban sprawl between San Francisco and Los Angeles. During the Collapse, an enterprising land developer named Richard Night bought up the majority of what was later to become the Corporate Center and City Center areas. He proposed to start a new, safe, clean corporate city, free of crime and urban blight. By offering lucrative tax

packages to several major corporations (PetroChem, for example, had established drilling rights off the coast), he was able to establish a strong economic base as well as an instant population of corporate employees.

As planned, Night City was a clean, open community with rapid transit, and safe streets. Unfortunately, Night's plan went awry. In using his own advanced building techniques and materials, he excluded a number of established unions and construction firms, many of these controlled by organized crime syndicates. Four years after initial construction, the powerful gang bosses murdered Night and took over the Night City project.

Between selling contracts to their cronies, setting up drug and extortion rackets, and generally inviting the scum of the Collapse into the area, the gangs managed to turn a relatively clean, modern city into an embattled war zone. Crime, drugs, prostitution, random violence and cybernetic terrorism soon became the rule of law. By 2005, the name Night City had taken on a grim and deadly new meaning.

**The Corporate Takeover:** By 2009, the Corps decided they'd had enough. In lightning strikes, covert Solo squads eliminated most of the gang leaders and established a Corporation-controlled City Council. The newly elected Council, faced with chaos in the City, deputized Corporate security forces and allowed them full authority within the City limits. The Corporate and City centers were cleaned out and restored

to their pristine state. The old Harbor Mall (originally built in the 1980's), was demolished and the New Harbor Mall constructed.

### The Present

Night City today is a rapidly growing urban region, still rife with urban violence and street crime, but with strong economic growth in the Corporate sector. It is the quintessential city of the Cyberpunk future—gritty, dangerous, but possessing an urban slick and stylish cool that makes it unique. As Bes Isis, Net 54 newcaster and one of Night City's most well known public figures puts it—

*"Nobody ever leaves Night City. Except in a body bag."*

## Particulars

### Political

The Night City Mayor's Office owes everything to the Corporations, and accordingly, the Corps can do anything they want in Night City. The current Mayor of Night City is Mbole Ebunike, a well-trained corporate puppet recently elected for his second term in 2020.

### Public Services

**Hospitals:** There are two public hospitals (City Medical Center; Crisis Medical Center) in the Central Night City area, as well as another seven in the Greater Night City Area. There are at least four private medical centers in the City as well, mostly catering to cyberwear installation, bodybanking and biosculpture work.

**Information:** City information is provided for a nominal fee (1 eb/min) via Data Term. Data Terms are located on the corners of most (60%) City Streets, and can be used to access information, computer services, fax-mail and Net input.

**Law Enforcement:** Although much of Night City has been brought under Corporate control (these areas are

known as the Corporate Zone and are heavily patrolled by hired security), pockets of urban blight still infest the Marina, Harbor and Lake Park districts. Crime in these Controlled Zones is kept in check by brutal security sweeps and constant surveillance. The South City is still a seedy ruin of cheap tract housing, spreading into an area so blighted, it is known as the Combat Zone.

**City Police Services:** Police in Night City are scattered, poorly equipped and badly managed. Cops can often be bribed or convinced that they just don't want to get involved. The most incorruptable people on the Force are in **C-SWAT**, the CyberPsycho Squad. Determined and dangerous, these mavericks and loners are just too crazy to care about being on the take.

### Transportation

**Public Transportation:** The Night City Transit Corporation (NCTC) provides for bus service on most major city thoroughfares. Light lev-rail transport is provided by **NCART** (Night City Area Rapid Transit), a public corporation with some private (read: Corporate) funding.

**Night City Metro:** The local airport, handling both domestic and international flights. Night City is on the hourly San Francisco to LA commuter run, as well as daily flights to New York, Chicago, Atlanta and Washington.

**Suborbital flights** are available by taking the LA commuter flight, then transferring via Orbital Air maglev train to the Mojave Spaceport.

**Freeways:** Night City is on State Highway 828, which runs east to connect to I-5. Ground transit to San Francisco is about 4 hours (due to road gang activity and bad roads); to LA about 6 hours.

**FOR MORE ABOUT NIGHT CITY, CHECK OUT  
RTG'S NIGHT CITY SUPPLEMENT (CP 3501)  
AVAILABLE AT YOUR LOCAL HOBBY STORE.**



### Places of Interest

Following are some of the major attractions and possibilities of Night City.

- 1 City Hall
- 2 City Library
- 3 City Museum
- 4 Hall of Justice
- 5 **Marcini's:** A large, expensive department store where you can find almost any luxury item.
- 6 **Raven Microcyb**
- 7 **Microtech**
- 8 **Arasaka Tower**
- 9 **Eurobusiness Machines**
- 10 **Petrochem**
- 11 **Network 54 offices**
- 12 **Plaza Business Tower** (96 stories of assorted businesses)
- 13 **West City Tower** (88 stories of assorted businesses)
- 14 **Infocomp**
- 15 **WNS offices**
- 16 **Orbital Air Offices**
- 17 **Merrill, Asukaga & Finch**
- 18 **The Twilight Zone**
- 19 **1st Night CityBank**
- 20 **Euro-Worldbank**
- 21 **Grandmill's** (large, expensive department store)
- 22 **Totentanz:** When the owner of this bar named his bar **Deathdance**, he didn't know how right he would be. A dance hall/bar housed on the top floor of an old skyscraper, this bar is well-known for a place to find **Boostergangs**. They all seem to congregate here, but they don't come to dance for the pleasure of it. It's considered a bad night if the body count is under twenty.
- 23 **WorldSat Communications**
- 24 **Hotel Hamilton:** A fairly modern hotel, known for its excellent security.
- 25 **Highcourt Plaza Hotel:** A very classy hotel featuring glass elevators, excellent service, and a 1920s decor.
- 26 **Trauma Team™ Offices**
- 27 **Industrial Park**
- 28 **City Medical Center**
- 29 **REO Meatwagon** (rival medical team) **Offices**
- 30 **Atlantis:** A classic "fern bar," known as a hangout for **Corporates** and **Solos** looking for jobs.
- 31 **Jesse James' Non-Kosher Deli:** While this may sound like an ideal place to eat, no food is ever served here. The Deli is a bar that was constructed in an old police station. Due to several unforeseen "accidents," you must register your personal weapons at the door and use the safe ones that are provided for you at the bar. There is a nightly contest to see who can get the highest body count in five minutes.
- 32 **The Outer Limits** (club)
- 33 **Rainbow Nights:** **Rainbow Nights** is more of a dance club than a bar. Its main attraction is a big dance floor that is almost always crowded. Every night there is a live band, usually a bunch of no names. They occasionally draw big acts like **Johnny Silverhand** and **Kerry Eurodyne**, but only under aliases.

- 34 **Medical Technologies** (a body bank)
- 35 **City Police Precinct #1**
- 36 **Short Circuit:** The **Short Circuit** is one of many bars in Night City. Like most of them, this bar has its regulars, who seem to mostly be **Netrunners** and **Techies**. Unbeknownst to most of the city, however, **Livewire**, one of the most reknowned **Netrunners**, has a shop in a back room of the bar where he buys and sells programs for use in the Net. In addition to his trading of programs, **Livewire** is also adept at creating his own programs, or ones that other people order.
- 37 **City College**
- 38 **Savage Doc's** (a **Ripperdoc** joint)
- 39 **City Police Precinct #3**
- 40 **Night Owl:** One of the few bars that is open all night. This is a heavy security, no-nonsense bar. You come here to drink when nothing else is open.
- 41 **West City Bank**
- 42 **Crisis Medical Center:** a no-questions-asked medical center for fast patchups.
- 43 **Café Chrome:** a favorite **Rocker** hangout, complete with 50's retro decor and jukebox.
- 44 **MetalStorm:** A dangerous **Chromer** bar
- 45 **Warehouses**
- 46 **Warehouses**
- 47 **Medicross Preservation:** an illicit body bank, not too particular about I.D.'s or death certificates.
- 48 **The Slammer:** Well-known among **Boostergangs** as a place to settle disputes peacefully. If that doesn't work, the arena is there to settle them violently. The owner, **Suds Joliet**, also runs betting booths and occasionally rents out the arena for other events.
- 49 **Camden Court:** High security condos favored by **Solos**, Corps. Rent is \$3,000.00 a month.
- 50 **McCartney Field Stadium:** Main concert venue and home of the **Night City Rangers**, the local football team.
- 51 **City Police Precinct #2**
- 52 **Wing Chang:** Exclusive chinese restaurant.
- 53 **La Baguette:** Very trendy French cuisine.
- 54 **Hari Kiri:** Sushi Bar
- 55 **New Harbor Shopping Mall**
- 56 **Grand Illusion** (dance club)
- 57 **The Afterlife:** This bar is located in an old mortuary in Night City. Consisting of three rooms, **The Ante-Chamber**, the **Crypt**, and **Hades**, this bar is a favorite among **solos** that are currently between jobs. If you need to find armed help, this is the place to go.
- 58 **Night City Fire Station #1**
- 59 **Lake Park Bandstand**
- 60 **28th St. Park** (contested **Boostergang** turf)
- 61 **28th Street Underpass** (a **Boostergang** meeting spot)
- 62 **Night City Fire Station #2**
- 63 **Bodukkan Performance Center**
- 64 **Forlorn Hope** (a **Central American Vet** bar)

**"Sex. Drugs. Rock and Roll. Fully automatic weapons with grenade launchers.**

**We got it all. This is a modern city..."**

**—Ripperjack**





# NIGHT CITY ENCOUNTERS

**Welcome to the mean streets of the City. These encounter tables are fast and nasty ways to keep your players moving, thinking and living Cyberpunk. Check the table for the time of day, then roll a percentage (two D10's, with one representing the 10's place) to determine the outcome. Feel free to alter the participants or the locale for extra variety.**

## DAYTIME ENCOUNTERS IN NIGHT CITY

**1-2 City Police:** One patrol officer, armed with AKR-20, armored in Kevlar vest. If you are wearing visible weapons or armor, he will stop you in a nice way and ask to see your identity papers. If you're argumentative, he will call for backup (3) officers to take you in.

**3-8 Corporate Guards:** Four corporate guards patrolling the area. Armored in vests & helmets, carrying Uzi's. If you're armed in a visible fashion, they will tell you to move on in a way that lets you know they're just itching to use those Uzis.

**9-14 Nomads:** Four Nomads from the Johannson Clan. Huge, rough-hewn blonde Vikings in flack vests and leather pants, carrying fighting knives and rifles. If there are attractive women in your group, they will whistle and make a general attempt at a pass. If not, they will move on.

**15-20 Boostergang:** Four low-level street punks in the colors of the *Metal Warriors*. They are armed with scratchers and wearing armor jackets. If your party is larger than theirs, they will avoid you. If of smaller or equal size, they will try to rough you up right on the street.

**21-23 Petty Criminal:** One pickpocket. His REF is 8, his pickpocket skill is +6. Armed with only a knife. If he's successful, you have lost your wallet (and all cash, cards, etc). If he fails in the attempt, feel free to beat him to a pulp. It can only improve his technique.

**24-29 Solo Team:** Three Solos, armed in flack vest & pants, carrying a mix of assault weapons. If you are wearing a rival Corporate uniform or patch, they will: 1-5, look you over and move on; 6-10, they will pick a fight. If you are wearing their Corporate colors, they'll ask you to join them for a drink. Roll 1D10 and take your chances.

**30-33 Boostergang:** Six members of the *Iron Sights* gang, armed with automatic pistols and rippers. They will hassle any attractive men or women in the party (the gang is mixed sex), shake you down for money and generally be looking for a fight. Go ahead and give it to them.

**34-39 Techies:** Two Techies, without weapons or armor. If you are wearing any unusual weapons or cybertech, they will stop you and ask to look. If it's removable, they may offer to trade some Skill chipware (up to the Referee's discretion) in exchange.

**40-42 Culties:** The *Inquisitors* are out in force on the Street. Six of them, armed with hidden nunchaku, corner you to hand out literature. If you are wearing any visible cybertech (arms, eyes with logos, etc.), be prepared to be heavily harrassed and followed. If you use any violence, a minor riot may develop.

**43-45 Private Investigator:** You observe him/her shadowing you. The PI is armed with a heavy caliber revolver and wearing an armor jacket. If you rough the PI up a bit, you may discover that he/she thinks you are someone else.

**46-51 Corporates:** Two corporates from a middle level firm, headed for lunch. One is wearing an armor T-shirt under his/her suit. Neither are armed, but both carry cell phones. Roll 1D10. 1-4, they are being followed by thugs intent on robbery—if you feel altruistic or just want to score a reward, here's your chance. 5-8, they are lost and will ask directions to the restaurant (you could lead them the wrong way and mug them in an alley). 9-10, they know you from a previous encounter and stop you on purpose. Not good, probably.

**52-57 Medias:** A camera and interviewer team, doing random "man-on-the-street" stories. The subject of the interview will vary widely, depending on recent events and what's considered controversial at the time. If you want to be well known, this will put your face on TV screens all over Night City. On the other hand, it may alert your worst enemies to the fact that you are still alive.

**58-64 Locals:** Young men or women (2 to 6 total). Roll 1D10. Will be friendly on 1-5, hostile on 6-8, abusive on 9-10. No weapons or armor. These guys must be crazy.

**65-70 Crazy:** Some bearded, wild-eyed freak in torn rags. Roll 1D10. On 1-5, he rants at you a while, then starts to rant at someone else. 6-8, he decides you are one of the space aliens from Venus, and follows you, screaming invective. 9-10, he starts to scream, passes out in front of you, and everyone around thinks you had something to do with it.

**71-75 Trauma Team:** Standard 5 man team on a lunch break. Their AV is parked at the end of the corner, while their Solos keep watch. This might be a good time to make friends and spread a little "insurance" Eurobucks around.

**76-81 Rockerboys:** A three man band on the way to practice. Carrying real guitars and wearing leathers, no less. Roll 1D10. On 1-4, they will invite you to their gig tonight.

**82-90 Posergang:** Five members of the well-known *Kennedys* Posergang. Two male members look like RFK, one looks like JFK, the two females look like Jackie. If your group says anything—anything—about their appearance, their boosted hearing will pick it up and they will immediately take offense. They are wearing armor Ts under their retro-style 60s clothing and carrying Hvy. Handguns. JFK has a cyber-chrome right arm.

**91-96 Security Guards:** You're treading too close to the tail of an important Corporate. These guys will come back and warn you off. Flack armor, Sternmeyer 35's, boosted Reflexes.

**97-00 Media Star:** Famous media star. Roll 1D10. 1-6, will sign autographs if asked. 7-9, will be hostile and yell for a policeman or a bodyguard. On a 10,

he/she will take a liking to one member of the party and allow you to tag along.

## EVENING ENCOUNTERS IN NIGHT CITY

**1-5 City Police:** Two patrol officers, armed with FN-RALs, armored in flack vests, pants. If you are wearing visible weapons or armor, they will stop you and demand identity papers. If you're argumentative, They will call for backup (3) officers to take you in. If you reach for a weapon, they'll shoot first, fill out the paperwork later.

**6-11 Corporate Guards:** Four corporate guards patrolling the area. Armored in flack vests & helmets, carrying Minami 10's. Unless you're a Corporate, they don't think you have any business running around their nice clean city at night. Move it, punk.

**12-17 Nomads:** A mixed group of six Nomads from the *Roadrunners* Pack. Wearing flack vests and leather pants, carrying fighting knives and rifles. Moderately drunk and looking for a fight. They will hassle any attractive looking men or women in your group. Face it; they want a fight. Give them one.

**18-24 Boostergang:** Five low-level street punks from the *Piranhas* boostergang. If you look like easy prey and have money, they'll rough you up. They are armed with Med. Handguns, knives and boosted reflexes.

**25-30 Street Punks:** Six Smash-heads, looking for credit to feed their habit. If you're not wearing Corporate or booster colors, they'll try to rush you right on the street. Armed with fighting knives; no armor.

**31-36 Solo Team:** Four Solos, armored in flack vest & pants, carrying smartgun chipped H&K MP5Ks. Boosted reflexes, boosted hearing, cyberoptics with low light, IR and targeting. Obviously up to some grey operation. If you are wearing a rival Corporate uniform or patch, they will: 1-5, dodge you and move on; 6-10, decide you are a witness and ought to be totalled right now.

**37-42 Boostergang:** Six members of the *Iron Sights* gang, armed with automatic weapons, rippers, IR cyberoptics, boosted reflexes. They will hassle any attractive men or women in the party (the gang is mixed sex), shake you down for money and generally be looking for a fight. This might be tougher than the daylight crowd was.

**43-44 Techies:** Two Techies, with one Minami 10 submachinegun, wearing flack vests. Roll 1D10. 1-2, they are lugging a crate of tools into an AV-4. 3-5, they are working on a City system in your path. 6-10, they are walking toward you on their way to work.

**45-50 Culties:** The *Inquisitors* are out in maximum force. Six of them, armed openly with nunchaku, corner you for inspection. If you are wearing any visible cybertech (Arms, eyes with logos, etc.), they will proceed to beat you to a pulp.

**51-54 Private Investigator:** Roll 1D10. On 1-3, he/she is ahead of you, hassling an informant on the streetcorner concerning the whereabouts of a suspect. 4-7, he/she is shadowing someone ahead of you. 8-10, they will stop you and ask you whether you have seen the person they are following. The PI is armed with a heavy caliber revolver and wearing an armor jacket.

**55-57 Corporates:** Four corporates from a large firm, headed for the lev train station. Both are wearing armor T-shirts under their suits and carrying poly-

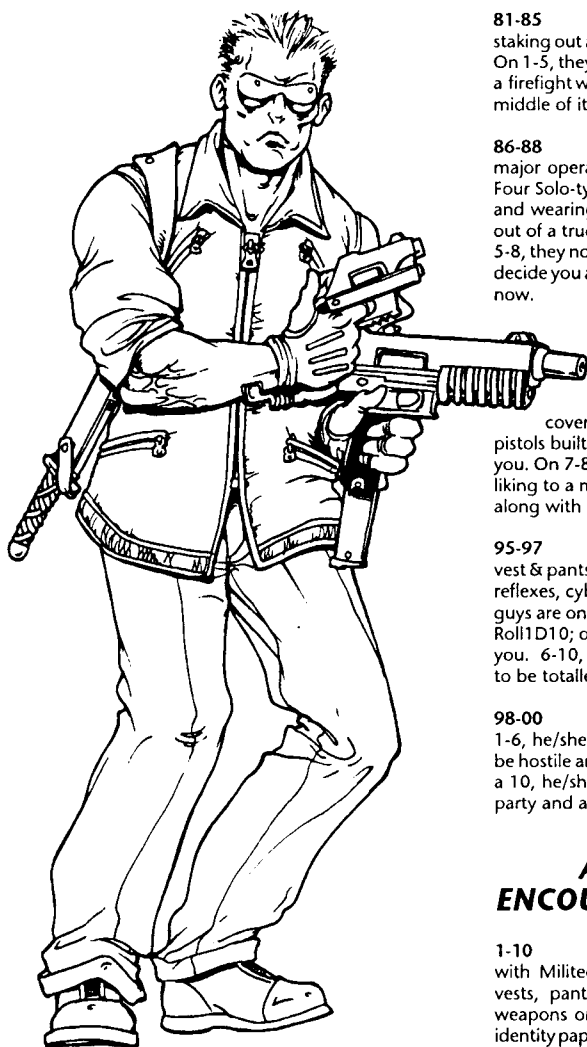

**81-85 Medias:** A camera and interviewer team, staking out a building on a hot assignment. Roll 1D10. On 1-5, they will be spotted by their story-subject and a firefight will ensue. You, of course, will be right in the middle of it.

**86-88 Major Criminal:** You've walked into a major operation of the notorious *Scagattalia Family*. Four Solo-type men armed with Med.& Heavy pistols and wearing flack vests, are unloading a drug cargo out of a truck. Roll 1D10. 1-4, they don't notice you. 5-8, they notice you and one warns you off. 9-10, they decide you are a witness and ought to be totalled right now.

**89-94 Chromers:** Four members of the *Steel Slaughter Slammers*. They are wearing armor Ts with metal spiked leathers. All have metal arms covered with chrome, with rippers and Med pistols built in. Roll 1D10— on a 1-6, they will go for you. On 7-8, they'll pass you by. On 9-10, they take a liking to a member of the party and invite you to tag along with them.

**95-97 Solo team:** Three Solos, armed in flack vest & pants, carrying smartgun chipped Uzis. Boosted reflexes, cyberoptics with low light, targeting. These guys are on a total black operation (an assassination). Roll 1D10; on a 1-5, if you ignore them, they'll ignore you. 6-10, they'll decide you are a witness and ought to be totalled right now.

**98-00 Media Star:** Famous media star. Roll 1D10. 1-6, he/she will sign autographs if asked. 7-9, will be hostile and yell for a policeman or a bodyguard. on a 10, he/she will take a liking to one member of the party and allow you to tag along.

### AFTER-MIDNIGHT ENCOUNTERS IN NIGHT CITY

**1-10 City Police:** Two patrol officers, armed with Militech Ronin assault rifles, armored in flack vests, pants, helmets. If you are wearing visible weapons or armor, they will stop you and demand identity papers. You've got no business running around after midnight and they know it. They'll stop you and look for any pretext to make a bust. If you're wearing visible weapons, consider yourself detained. If you go for a weapon, they will shoot first and forget the paperwork.

**11-22 Corporate Guards:** Four corporate guards patrolling the area. Armored in flack vests & helmets, carrying FN-RALs. "What are you doing on the property after midnight? Can't have a good reason! Blam! Blam! Blam!"

**23-30 Nomads:** A mixed group of four Nomads from the *Wildman Pack*. Wearing flack vests, tatoos and leather pants, carrying fighting knives and rifles. As long as you stay clear of their bikes, they'll ignore you and concentrate on beating that family of Corporates to mush.

**31-40 Boostergang:** Five low-level street punks from the *Crazy Chicken* boostergang. They are armed with .45 automatics, knives and boosted reflexes. They're looking for 'Lacers or any other possible source of ready cash. Roll 1D10. On 1-7, you're it.

**41-50 Street Punks:** Four Lace addicts, looking for credit to feed their habit. Even if you're wearing Corporate or booster colors, they'll rush you. These guys don't care, and they don't feel pain. Armed with fighting knives, scratchers; no armor.

**51-60 Solo Team:** Two Solos, armed in flack vest & pants, carrying smartgun chipped H&K MPK-9. Boosted reflexes, boosted hearing, cyberoptics with

low light, IR and targeting. Obviously up to some grey operation. If you are wearing a rival Corporate uniform or patch, they will: 1-5, dodge you and move on; 6-10, decide you are a witness and ought to be totalled right now.

**61-75 Boostergang:** Six members of the *Blood Razors* gang, armed with automatic weapons, rippers, IR cyberoptics, boosted reflexes. Hassle you? Naw...they'll just torture you and listen to you scream. For fun. Afterwards, they'll sell the body to the Donor Center for cash.

**76-80 Culties:** It's Inquisition time! The *Inquisitors* are out in maximum force. Six of them, armed openly with nunchaku, handguns and whips corner you. "Only a servant of the Metal Demons would be abroad at this hour. Any decent citizen would be at home, asleep. Hack, slay and maim the heretic!"

**81-82 Private Investigator:** Roll 1D10. On 1-3, he/she is ahead of you, hassling an informant on the streetcorner concerning the whereabouts of a suspect. 4-7, he/she is shadowing someone ahead of you. 8-10, they will stop you and ask you whether you have seen the person they are following. The PI is armed with a heavy caliber revolver and wearing an armor jacket.

**83-86 Chromers:** Four members of the *Steel Slaughter Slammers*. They are wearing armor Ts with metal spiked leathers. All have metal arms covered with chrome, with rippers and .45 cal built in. Roll 1D10— on a 1-6, they will go for you. On 7-8, they'll pass you by. On 9-10, they take a liking to a member of the party and invite you to tag along with them.

**87 Medias:** A camera and interviewer team, looking for a story. Roll 1D10. On 1-5, they will be spotted by their story-subject and a firefight will ensue. You, of course, will be right in the middle of it. on a 6-10, they'll decide you're the story and follow you.

**88-90 Locals:** Young man or woman. Roll 1D10. 1-5, they are being beaten by four thugs from the *Blood Razors* gang. 6-10, they are being beaten severely by the *Inquisitors* for the sin of having designer eyes.

**91-95 Firefight:** Great. You just walked into a major altercation between the *Bradi Bunch* (a high-level Posergang that all look like refugees from an old sitcom) and the *Red Chrome Legion* (a neo-facist Boostergang). Both are wearing armor jackets and firing large caliber handguns. Rippers, cyberarm weapons and slice-n-dices are everywhere. Pick a side, or pick a target.

**96-98 Trauma Team:** The AV-4 hits the ground in the middle of a recent firefight. Roll 1D10. On a 1-5, the Team decides you're bystanders and ignores you. On 6-10, they figure you're part of the problem and the Solos open up with MAC10s.

**99 Major Criminal:** You've walked into a major operation of the notorious *Scagattalia Family*. Four Solo-type men armed with Ingram MAC 14s and wearing flack vests are unloading a drug cargo out of a truck. Roll 1D10. 1-4, they don't notice you. 5-8, they notice you and one warns you off. 9-10, they decide you are a witness and ought to be totalled right now.

**00 Solo team:** Three Solos, armed in flack vest & pants, carrying smartgun chipped Uzis. Boosted reflexes, cyberoptics with low light, targeting. These guys are on a total black operation (an assassination). Roll 1D10; on a 1-5, if you ignore them, they'll ignore you. 6-10, they'll decide you are a witness and ought to be totalled right now.

mer one shots. Roll 1D10. 1-4, they are being followed by thugs intent on robbery. 5-8, they think you're Boosters and will open fire at any provocation. 9-10, they not only think you're trouble, but will call for Corporate backup (see Corporate Guards, above).

**58-64 Locals:** Young man or woman. Roll 1D10. 1-5, they are being held up by two thugs from the *Metal Warriors* gang. 6-10, they are being beaten severely by the *Inquisitors* for the sin of having designer eyes.

**65-70 Firefight:** Great. You just walked into a major altercation between the *Bradi Bunch* (a high-level Posergang that all look like refugees from an old sitcom) and the *Red Chrome Legion* (a neo-facist Boostergang). Both are wearing armor jackets and firing large caliber handguns. Rippers, cyberarm weapons and slice-n-dices are everywhere. Pick a side, or pick a target.

**71-75 Trauma Team:** The AV-4 hits the ground in the middle of a recent firefight. Roll 1D10. On a 1-5, the Team decides you're bystanders and ignores you. On 6-10, they figure you're part of the problem and the Solos open up with MAC14s.

**76-80 Rockerboys:** You overtake a four man band on the way to a gig, backed by their two Solo bodyguards and their Fixer manager. Roll 1D10. On 1-4, they will invite you to join them. 5-8, they will send the Solos to "deal with those guys who are following them." 9-10, they ignore you.

# SOME PERSONALITIES OF NIGHT CITY

**Introducing a few people you're likely to meet at any time on the Streets of the City. These Personalities are designed to be played as general character classes.**

**Fireman (Fixer):** Fireman is the most well known of the many local arms dealers. His main distinction comes from the fact that he supplies many of the legitimate businesses with security systems in addition to the weapons that their bouncers/hired solos use. Fireman was initially a cyber-soldier in the Nicaragua conflict, that used his contacts after leaving the service to supply his modest business. In addition to his arms dealing, Fireman is also involved in information dealing, something that makes him very popular with fixers in the city.  
 INT=6 TECH=5 REF=4 CL=6 LK=7  
 ATT=4 MA=5 EMP=6 BODY=5

**Blacklist (Tech):** A renegade chemical/cyber engineer from the Biotechnica Corporation, Blacklist makes his presence known in Night City in several ways. He is the man that Booster gangs see to get "personalized" cybernetics, the man that Corporations see to get viruses synthesized, and the man that the police talk to when they need help in identifying and analyzing chemicals used in crimes. Rumour has it that Biotechnica has a hit out on him for taking certain formulas that he developed with him when he left.  
 INT=6 TECH=8 REF=5 CL=8 LK=3  
 ATT=5 MA=5 EMP=4 BODY=5

**Suds Joliet (Rockerboy):** A retired Rockerboy who made his money on several classic 1990's albums, Suds now runs a speakeasy (specializing in his home brew) in an old warehouse. This speakeasy, known as *The Slam-*

*mer*, is a central meeting place for many peace talks between gangs. This is primarily due to the fact that the rest of the warehouse has been converted into an arena by Suds for non-peaceful resolutions to gang disputes. On occasion, Suds has been known to pull out his axe and play for the crowd.  
 INT=6 TECH=3 REF=6 CL=9 LK=5  
 ATT=4 MA=6 EMP=8 BODY=8

**David Whindam (Corporate):** David Whindam is a typical corp brown-noser, always looking for a way to get to the top quicker than anyone else. Two years ago he formed his own personal hit squad of solos known on the streets as the *Lead Messengers*. After successfully removing several people that were in the way of his making president of the local division of Biotechnica, he realized that there was a lot of profit to be made in hiring out the *Messengers*. He now "loans" them to other corporate friends of his in order to help them gain power. He has the vision of total city control once he has all of his "friends" in power.  
 INT=8 TECH=3 REF=7 CL=9 LK=5  
 ATT=7 MA=5 EMP=3 BODY=7

**Strawberry (Cop):** Strawberry was given his name for his naturally red hair, an unusual sight in Night City (the fact that it's natural, not the color). Strawberry is a cop who has spent all of his fifteen years on the force walking the streets of Night City. Although he has sworn to uphold the law, he also knows when to look the other way. Strawberry is a rarity in the 2000's; he cares. Instead of busting someone who is doing drugs, he generally takes them to a detox clinic, with the hope that they will beat the habit. Although he is a cop, almost everyone on the streets will go out of their way to help him out in a pinch.  
 INT=6 TECH=3 REF=10 CL=7 LK=9  
 ATT=4 MA=7 EMP=10 BODY=9

**Hypo (Nomad/Booster):** No one knows where Hypo came from, but everyone agrees that he is crazy. He was given his name after he opened a detox clinic in the worst part of Night City. Unlike the major detox clinics, Hypo does not charge anything for his services except for a promise that his successes will try and help someone else by bringing them to his clinic.  
 INT=7 TECH=2 REF=8 CL=7 LK=8  
 ATT=6 MA=6 EMP=8 BODY=7

**Livewire (Netrunner):** Livewire is a Netrunner who used to be associated with a solo team known as the *Devil's Horde*, until the team disbanded in 2011 due to a mishap in an operation that killed off everyone except Livewire and one other member. These days Livewire can usually be found in a small shop that he runs out of the back room of the Short Circuit, a local bar. It is said that he has access to any program for the right price; and if he doesn't have it, he will make it.  
 INT=9 TECH=6 REF=10 CL=10 LK=9  
 ATT=8 MA=8 EMP=4 BODY=7

**Lucifer (Solo):** Lucifer is the founding member and only survivor of the *Devil's Horde* besides Livewire. Known for his vicious, no holds barred hand to hand combat style, Lucifer can be bought for the right price. He generally keeps to himself, but has been known to work with Livewire on occasion.  
 INT=6 TECH=3 REF=10 CL=9 LK=8  
 ATT=10 MA=9 EMP=4 BODY=8

**Athena (Netrunner):** Athena is the leader of an all-woman boostergang known as the *Valkyries*. She is often found in the company of two of her "soldiers", Artemis and Hera. Beside her activities as the *Valkyrie* leader, Athena also runs the Net for a Solo known on the streets as Kestral.  
 INT=6 TECH=6 REF=9 CL=10 LK=4  
 ATT=8 MA=6 EMP=6 BODY=8

**Kestral (Solo):** Like many Solos, Kestral gained her combat experience in the Central American conflict. What makes her different is the fact that she

fought for a corporation that backed the losing side. Near the end of the war, Kestral saw that her side was losing and arranged to be "killed in action". After faking her death, she paid her way into a corporate solo team that was soon sent out on a suicide mission. Only her knowledge of the opposition and the place they were going to hit allowed her to escape certain death. Today she hires herself out to individuals only, having long since lost any trust in corporations.

INT=7 TECH=4 REF=12 CL=9 LK=8  
ATT=8 MA=10 EMP=5 BODY=7

**White Lion (Fixer):** The White Lion is one of Night City's most well known fixers. She has contacts into several of the main corporations as well as the underworld of Night City. Although most people have heard of her, very few know where to find her. She likes to keep her whereabouts a secret because she sold some information that led to the downfall of a wealthy mob family, who then put a hit out on her. If someone tries to collect on this hit, they will find themselves in deep trouble as there are many people who owe their lives to the White Lion and are more than willing to protect her.

INT=10 TECH=3 REF=7 CL=5 LK=9  
ATT=8 MA=7 EMP=7 BODY=7

**Pythagoras (Netrunner):** Pythagoras is a little bit of everything; Hacker, Netrunner, Techie. He is most well known for his abilities in adapting software that already exists, but he is not at all bad with creating his own. Although he tries to hide it, most people know that it was he that was solely responsible for the downfall of the Hiroshi Electronics Corporation after they threatened to set him up for refusing to work for them. It is this reputation that keeps other corporations from hiring his services.

INT=7 TECH=10 REF=9 CL=8 LK=5  
ATT=7 MA=7 EMP=5 BODY=5

**Watchmaker (Med Techie):** Watchmaker is both a biotechnician and a cybertechnician, whose claim to fame

was her invention of the *Skinwatch*. After a few years of working in the corporate world, Watchmaker decided that she could make more money on her own. She now resides in Night City and does a fair amount of renegade surgery for boostergangs and corps alike.

INT=9 TECH=9 REF=7 CL=9 LK=7  
ATT=9 MA=8 EMP=8 BODY=6

**Nostradamus (Media):** Unlike the Nostradamus of the 1400s, this one specializes not in the future, but in the past and present. He is somewhat of a recluse, living in a converted warehouse that has many defenses. Inside the warehouse lies the biggest collection of real books that are left in the City. Nostradamus uses these books along with a gigantic mainframe to compile all the information that he can. To facilitate this collection, he often hires Netrunners to acquire the saleable information that he is also known for brokering.

INT=10 TECH=2 REF=8 CL=9 LK=7  
ATT=6 MA=5 EMP=4 BODY=7

**Aries (Solo):** Aries is the living example of a man who has been through hell and come back to tell about it. Many years ago, he was a commander for the CIA, closely associated with the Gang of Four. After the fall of the United States, he ran covert operations in Central America for a while, then surfaced in Night City in 2010 as a high priced Solo. Over the years his humanity slowly drained away until he went 'borg about a year later. After his capture, which was well publicized by the media, he underwent the braindance and is now working for the Night City Police Force hunting down other 'borgs.

INT=8 TECH=5 REF=12 CL=7 LK=5  
ATT=5 MA=7 EMP=2 BODY=12

**Bes Isis (Media):** Bes Isis is a well known media who has a reputation for being slightly off-balance when it comes to scooping other medias. More than once, she has broken a few rules to get inside of some big story, sometimes at a cost. She now has one

chrome leg and a similar replacement for half of her chest. These replacements were necessary after she faked injury to get a story on "meat jumping."

INT=8 TECH=4 REF=9 CL=10 LK=8  
ATT=10 MA=7 EMP=7 BODY=6

**Music Man (Rockerboy):** Music Man is the equivalent of Night City's wandering minstrel. He has no set home, but plays for his lodging at various bars. In addition to his music, Music Man also sells information.

INT=5 TECH=6 REF=7 CL=9 LK=5  
ATT=6 MA=6 EMP=7 BODY=7

**Bag Lady (Fixer):** No one knows where she came from, but one day she appeared in Night City with a burlap bag over one shoulder that was full of sundry items, all of which were stolen. It has been said that she is the last person that people go to when they need something, yet she always seems to have it.

INT=8 TECH=2 REF=7 CL=6 LK=8  
ATT=2 MA=4 EMP=7 BODY=2





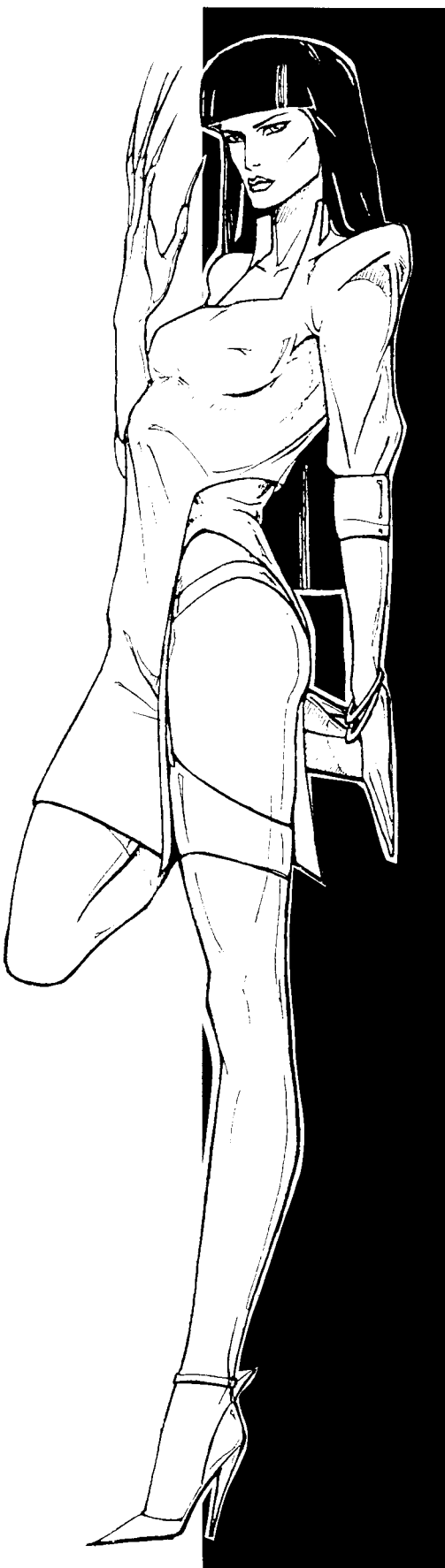

## ***Just another Friday night.***

***You pay your two bucks at the door and walk in. Over at the bar there are the usual lines, so you decide to skip the bar-front action. Feeling on top of the world, you go out to the main floor, for another night of the club life.***

***At first glance, the club seems like a mixing place of all types of people. Then you realize that they're all segregated. Posers at the back, trying to get noticed, your average punks in the middle, acting oblivious to their surroundings. There are Chromers bashing their heads against the walls on one side, while the Boosters are on the other, looking for trouble.***

***And last but not least there are the 'dorph-heads, slamming into each other at the front, next to the stage where the band of the night blares out hits of today and of the past.***

***They say people like Johnny Silverhand and Kerry Eurodyne got their start in clubs just like this one, but you think it's just hype. After all, people like Johnny Silverhand didn't need the clubs to make them larger than life, they were born that way. It's only Rock N' Roll, right?***

***Out on the Streets of Night City, there's stories going on—Street history being made. Whether it's Boosters in the alleys, Nomads on the Road, or Rockers in the clubs, there's action and trouble, everywhere you look. And the Trauma Team hovers overhead, waitin' to pick up the pieces—for a price.***

***Here comes a taste of the City. In your face.***



# "A Cool Metal Fire": Silverhand Still Can Rock

**Reprinted  
From  
ROCKERBOY  
MAGAZINE  
June, 2013**

From his humble beginnings in the group *Samurai*, to his first five solo albums, Johnny Silverhand has become the household word in rock and roll. With his latest release, *A Cool Metal Fire*, Johnny Silverhand is making his push to become a legend.

The album opens up as all of his solo albums have, with a rip roaring instrumental, "Dancing With My Axe," that is guaranteed to set your stereo on fire. This fast paced, no holds barred, display of guitar work is so hot that you'll want to listen to it twice.

And if that isn't enough in itself, you come to track two, "Chippin' In." This piece, like the first, is another fast paced lightning bolt of pure rock and roll. It also asks a question about today's society that cannot be ignored: If we continue the current trend of

replacing our body parts with metal, what will we have left in the end?

The rest of the album is almost typical Silverhand, with its energetic guitar playing and thought provoking

**"The album takes us to the heart of our culture and allows us to monitor its pulse.."**

lyrics. He does, however come up with three other songs that really stand out. The first two, "(Out of) The City" and "Flashing Lights," go so well together, both thematically and musically, that they almost seem to be one song in totality instead of two individual ones. These two songs bring out the ethereal vision of today from a non-partisan outsider that is innocent of our ways. It leaves the listener with a new way of looking at his own life,

even as it passes by at the speed of light.

The last song on the album, "Never Fade Away," departs from the mainstream sound of Johnny Silverhand and brings him into a new dimension musically. The basic rhythm is both simplistic and concise. This song makes no pretenses at being a song about today, but doesn't leave you with a gritty metal aftertaste like most of its peers. Although I'm not sure that this song really belongs with the others on the album because of its departure musically, I do know that it should have been recorded somewhere, so *A Cool Metal Fire* is as good a place as any.

Overall, I found *A Cool Metal Fire* to be more than just your ordinary, everyday record. With its driving beat and spellbinding lyrics, the album takes us to the heart of our culture and allows us to monitor its pulse.

## SILVERHAND UPDATE: CLONE TOUR BEGINS:

After six months of seclusion following an unsuccessful assassination attempt, Rockerboy Johnny Silverhand has re-entered the music scene to promote his new LP. The album, *Clone Wars*, deals with recent cloning breakthroughs and the idea of bioengineered humans being created for military and industrial purposes.

Interviewed in his Night City studio, Silverhand commented, "I needed a few months to let the heat die down over the last disk. *Clone Wars* was pretty intense, and a lot of people, particularly the Biotechnica guys, didn't like the slavery implications I wrote into it. I won't say they fronted the hit on me, but hey, you've got a brain, right?"

## Pretentious or Political? Seattle's Cutthroat.

**Review by Jeff Daniel**

*"The audience seems to consist of the mindless, overpainted, underdressed children that you would find at most Chromatic Metal concerts. Each one of them is so wrapped up in their own image that they often don't seem to even know who the band they are seeing is. Tonight is a night that they will always remember though, because Cutthroat is about to hit the stage."*

So reads the back cover of *Slashing Steel*, the new live album by *Cutthroat*. Some people think that these kings of Chrome are getting a little too preten-

tious when referring to themselves, but I had a chance to talk to Knifeedge, the lead singer and bassist for the band, who thinks otherwise.

**Jeff Daniel:** People often say that you guys are just a little pretentious when talking about yourselves. Why do you think that this is?

**Knifeedge:** That's easy. Unlike most Chromatic bands today, we take our roots from the old punk bands of the late 1970s and early '80s. It's not the blazing style that used to be called Speed Metal, though we do use that a lot. Politics is the driving force behind our band. It's because we are so political, that we force ourselves onto our listeners. If that is pretentious, then I guess we are.

**JD:** When you say you are a political band, what do you mean?

**K:** We view ourselves as messengers. It is our job to open the eyes of our

listeners with our music. The best eye-opening messages are in political issues and stories.

**JD:** Like the song "Kalakari"?

**K:** Exactly. Most people today don't even remember the name Hiram Kalakari, and they certainly don't remember what he did. It's songs about things that have shaped our lives that we play. We try and tell the truth as we see it, not what the public wants to hear.

**JD:** Then how do you explain the success of "Kalakari"? As of today it is currently number four on the EuroRadio top ten.

**K:** You got me. If we had known that it would be such a hit, well, I don't know. Maybe we would have done something different to promote the album. Though I suppose it's really not going to matter since I still think that the average person is not going to know who the f\*\*k Kalakari was.

**JD:** Getting back to your political motivation, how do you justify "Ginsu Lover" as being political?

**K:** Easy, I said we had our background in politics, not our entire lives motivated by it. But if you listen very closely, you will find out that it is a political song of sorts. "Ginsu Lover" is not about a sexual lover, but rather a member of a Boostergang who is overenthusiastic about using his Rippers. It's guys like the Ginsu Lover who make our streets unsafe to walk at night.

**JD:** What's next for Cutthroat? Slashing Steel is being called a new innovation in the music industry, how do you intend to follow it up?

**K:** You got me. When we released a live album of entirely new material, we expected to have our diehard fans buy it and that was it. Now the damn thing's gone and sold over two million copies. I expect we'll decide what's next for us after we tour.

—JD

# DESTINY: STILL ON THE EDGE, STILL FIGHTING THE WAR

*"Fifty years gone by / Since we heard our nation's cry / Fifty years gone by / Since we all watched you die"*

It is lyrics like these that make *Destiny* one of the most provoking bands of our time.

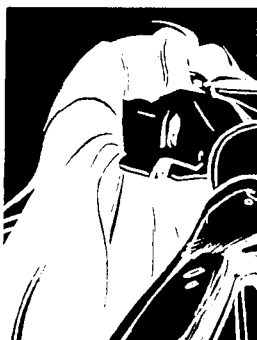

Jessie Moore of Destiny

Their new hit, "Song for John (Fifty Years)," is not only filled with political rhetoric, but also reminds us of a time when America was still great.

Since their debut album, "Walking the Skies", *Destiny* has consistently provided the listening public with songs that hit close to home. Bandleader Jessie Moore explains, "We didn't always used to be political. In fact, I didn't even care about anything other than making money until ten years ago. All I wanted was the fame, and all the benefits that came with it. Now times are different. It seems all I want now is to get my messages across."

But fame and fortune did elude them for many years until they got their big break opening for the now defunct *Cowboy Panzer*. It was on that tour that the audience really started to notice their music.

"I think it was the fact that *Cowboy Panzer* was so big and political. I found out that we were going to open for them on the tour and all of a sudden I knew that our music had to change. I must have written thirty songs on that tour, some of which were eventually worked into our set."

Despite the growing interest that

Jesse was showing in political issues, the band continued to produce other songs as well.

"I can remember the first time we went into the studio after the C.P. tour. I had all these songs that I wanted to record, but the group started right in on this bubblegum tune called, 'Input Out.' I was furious. I mean, here I was with this great message to sing and all these guys wanted to do was talk about bad relationships."

"It was about then when I threatened to quit. Thinking back on it now, I can understand why the band didn't think I was serious. I must have threatened to quit six times in the first nine months of our existence. And all the time I was using those threats so I could get my own way. I really was a spoiled brat.

"It took me about five months before I convinced them that I was serious. By then we had all ready recorded "My Baby Left Me For A Short Circuit". Pleading with the band, I convinced them to start over, using the stuff I had written on the tour, instead of stuff like, "Input Out". When it was all over, some ten months after we trashed the stuff from "My Baby", we had recorded, "Dinner With Himmler".

It was that album that attracted so much attention from the critics. They called it the new political feeling of the 2000's. The fame and fortune that *Destiny* had been looking forward to had been found.

Their second album after the *Cowboy Panzer* tour gained them even more notoriety. So much that they were able to tour as a headliner instead of a backup band. *Destiny* drummer, Timemaster, recalls:

"It was a big change. I mean one

day your opening for some big name group. Then you're a big name group. I can still remember the difference in the fans. One day you're slogging through an old number, listening to the fans yawning, and the next the fans are going wild.

"I remember this one gig we did on the *Cheyenne Mountain* tour when this sleek looking Chromer comes up to me and offers to jack in. This type of thing never happened as an opening band."

After the release of *Cheyenne Mountain* the band drew some flack from the Europeans. In fact, the album was banned for a while in several countries overseas.

"I can remember that", says Time-master. "Jessie was crushed. She was so into her new political mood that she got depressed that the entire world wasn't hearing her message. But it wasn't the Europeans we had to worry about. Back here in the United States we had several corporations, who shall remain nameless, who wanted our heads on worldwide news.

"More than once on that tour we had our backstage crew and roadies, which included a couple guys who used to be professional wrestlers back in the '90's, toss some people out who wanted to do something other than give us praise."

The band still has some problems with fans. Two times on the last tour there were fans arrested for trying to break into the tour bus. And on more than one occasion there have been young women claiming to have been attacked by band members.

"Yeah, I know all that stuff. But what really gets me is that all our real fans know that the two posers arrested were 'dorped out and looking for a place to recycle. As for those "rape" attempts, those are just corporations trying as best they can to get us out of the spotlight. Our true fans know that we are all involved in permanent interfaces."

Destiny. A band fighting for the truth. In a struggle against corporations that don't want to hear the truth, all they can do is hope to survive.

## NOMADS: TWO VIEWS FROM THE ROAD

BY JAMES NERDWELL

### The McCains: Farmers on the Run

Bud and Martha McCain tried to hold onto their land, but the Agri-Corps were determined to remove them. Even after the Agri-Corps bought the local bank so they could foreclose on their property, the McCains were steadfast in their resolve to remain on the land that had been in their family for generations. Then came the "bad luck"—their eldest son perished in a car "accident", their daughter made an addict by Corporate drug lords.

Then came the plague. Within twelve hours, all of the cattle and the poultry were dead; the crops, withered husks. The McCains left their land, promising to someday retake what was rightfully theirs. It was a dream they shared with many others.

Over years, the McCains have formed a new family, a family of the homeless and the dispossessed. They

came on foot, on motorcycles, in fleets of R.V.s. Under the leadership of Bud McCain, they formed a roving community, known as the Huskers to outsiders due to their Corn Belt roots. Travelling the roadways of America, finding work where they can, setting up camp when they are able, moving on when the locals can no longer tolerate them, the Huskers have a common goal—to someday retake their land.

Labeled as terrorists for their bold strikes against the industries which have rendered them homeless, the McCains prefer to think of themselves as honest folk turned freedom fighters. The Huskers have long memories. Those who befriend them have an ally for life, those who anger them have a dangerous foe. Will the McCains retake their stolen homeland? Time will tell. But with every new atrocity committed by the Agri-Corps, their numbers grow.

### The Crazy Quilts: Mercenary Brotherhood

The Central American Wars were hard on the soldiers who fought in them. Harder still was coming home. The cities were urban wastelands, unsuited for raising a family. Homes, towns, whole cities had disappeared off of the maps, victims of progress.

These young soldiers returned to an America in which nothing was sacred, and everything was for sale. Many found that they were unwelcome relics of the past. With nothing else to turn to, many of these dispossessed combat men and women turned to the only support network they had, each other; and the only profession they knew, soldiering.

Recruited from all over the country, the Crazy Quilts are one such group. Together, they formed one of the many offshoots of Nomad culture, the mer-

cenary brotherhood. Named for their colorful uniforms, a ragtag collection of fabric scraps roughly forming a camouflage pattern, they sell the one commodity they have left in a ruined world; their honor and fighting skills.

The Crazy Quilts hire themselves out, whether singly or in small battalions. Many act as bodyguards, others hire out as freelance mercs, corporate extraction forces, or as hit men and assassins. The Crazy Quilts place honor above all else. You can be certain that they will never turn upon their employers, never sell out, never back down, and never desert a comrade.

The Crazy Quilts consider themselves the last bastion of professional integrity in an otherwise chaotic society. It is this uncompromising reputation which has made the Crazy Quilts a powerful and respected force in this *Cyberpunk* world.

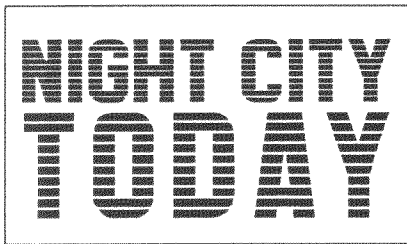

December 17, 2020

Volume CCVI, No. 46

REPORT

Walter Pickering's Night City Streets

Street Direct With The Blood Razors

Dateline Night City—The City's never really dark, not for those who live and die in it. A relentless neon circuit of steel and glass. Night in Night City is a hot pulsing thing. You feel it coursing through the wacked out veins of drugged up dorph heads, high on Lace and Slam. See it in the cookie cutter stares of pale faced posers, just out from under the knife. But no matter what your kick is, you're probably not experiencing it alone. You belong in the City, or you die. People congealing together like spattered blood, moving to a thousand different songs.

You hear the Blood Razor's song only once, and you never forget. I'll never know why a group of Boosters like the Razors let me run a night with their pack; maybe I caught Hack Man, the Booster chieftan in a good mood. It was party time: Hack's kid brother was getting his claws.

Just a short brief for you folks out there in the burbs; you've probably never heard of these Booster boys before. Here in the City, they're as common as crud on the sidewalk. Gangs like the Razors have fused cyberwear and fashion into a deadly form of street violence that has been claiming the

Cont. Pg. 219

BOOSTERGANGS: No Street is Safe

A Special Report

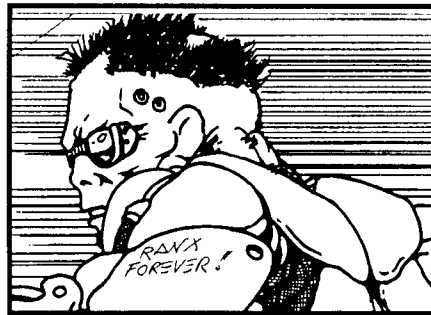

By Mikuru Ponsumisu

There's a fire on the Street, engulfing your neighborhood. Fueled by cheap designer drugs, cheap cyberwear, and cheaper automatic weapons, the fire of gangsterism once again threatens to annihilate Night City.

In the past two weeks, random shootings have escalated by fifty percent; yesterday, two innocent bystanders were gunned down in a hail of weapon fire as they walked down to the corner FoodMart. Their crime: walking through a section of Crazy Chicken turf during a gang dispute.

Gangs. They're your neighbors. They're your kids. You need to know these guys and be ready for them. Because in Night City, no street is safe:

**Bradi Bunch:** The *Bunch* is an extended family gang which protects runaway children. A few older "adults" run the gang and protect the turf, while the younger members steal, and deal for family support. Extended families are territorial and fiercely protective of their members.

**Red Chrome Legion:** The Legion is a *skinhead* gang; young males united around a certain hate group ideology. Uniforms, flags and militaristic slogans are the rule. The Red Chromers

will attack anything that they think isn't "right" (read: just like them).

**Steel Slaughter Slammers:** A typical *chromatic metal* gang. Chromer gangs like centering activities around their favorite rock bands, interpreting song lyrics as orders from their heroes. Chromatic rock gangs are into totally senseless, random acts of violence as a means of expression.

**The Gilligans:** The *Gilligans* are a typical *self defense* gang; in this case, militant gays who are tired of being attacked by groups like the *Red Chrome Legion*. They are relatively peaceful, as long as you stay off their turf (the Marina district), and leave them alone.

**The Kennedys:** The *Kennedys* are a typical *posergang*. Posers adopt the clone look for protection (one Kennedy looks just like another), identification and impact (twenty JFKs are a pretty scary sight). These gangs center on recreating their own bizarre interpretations of their heroes; for example, the *Kennedy's Hyan-nisport Weekends*, where all four hundred members descend on a location for a week-long orgy of destruction.

**Metal Warriors:** The *Metal Warriors* are a *combat gang*, with their activities centering around a type of "warrior's code". Elaborate combat rituals, ranks, and body armor are all part of the mystique. Combat gangs are dangerous, because once they declare a war on someone, they never give up.

**Piranhas:** The *Piranhas* are a typical *party gang*. They party, drink Smash, take (and deal drugs), and mug people, all as part of a "just because" lifestyle. To these guys, the Party is everything.

**Inquisitors:** The *Inquisitors* are a *cultie gang*; like the hate gangs, they center on a specific ideology, in this case, religious. The *Inquisitors* think cyberwear is blasphemous, and think nothing of tearing it right out of your body. They consider this "saving" your soul.

From Pg. 218

lives of more than forty citizens a week. The average Booster is an amoral technophile. Hardware and Wetware are the meat and drink of the Booster, and they'll do anything to get it. Arson, robbery, muggings, assassinations. If there's money in it, enough for another small boost at a blackmarket clinic, the Booster will take to it like chrome on a pair of mirrorshades. It's easier every time, they say. As more and more hardware's grafted, sockets drilled, and chips implanted, the Booster sinks further into his psychoworld machine-altered chaos. The best of them become the ring leaders, the worst are killing machines, riding on the edge of cyberpsychosis, ready to flatline themselves and everyone around them for that last big score.

Worst of all, Boosters travel in packs.

Maybe it was my arm, the one I lost in Lima, that endeared me to the Razors' top brass. It was an old model, military, and the dull steel and chipped plastic put me on their level. They had shackled themselves in an old warehouse, off of the main sprawl. In twos and threes they filtered in, screaming and shouting over deafening hardcore street rock. A few grabbed oiled rags and started cleaning their claws, fresh blood from a bunch of posers looking for action. Hack Man sat on his plastic throne, staring out through gunmetal eyes at the graffiti-covered walls of the nest. Dorphed up, he wasn't in the mood to answer questions. Only when his brother staggered in was there a flicker from behind the stone cut face. Metal arms crossed over armored chest, he popped his claws. A signal for the rest.

They came at Hack Man's bro from all sides, animal cries tearing from their throats as claws popped from housings in fingers. Steel and flesh monsters, pushed on by drugs music, hardware, and each other. The kid bared his teeth as the first pair made their pass, striking home, rending bloody tears in his flesh with a sur-

geon's skill. He didn't fight, didn't run, didn't cry out. Soon his arms, legs, chest were covered with thin lacerations. Knees buckling, he fell to the floor. I watched with facinated horror as the pack pounced on their prey, kicking and biting. In minutes, it was over. They dragged the broken kid before his older bro, throwing him before their chieftain's feet.

"Get up," the Hack Man snarled.

The kid pushed himself up to his knees, stared out into nowhere. "It hurts," he muttered through swollen lips.

The kick sent him sprawling across the floor of the nest. "Life hurts," said Hack Man over the jeers of his gang brothers. "You were born into a world of pain. If you don't like it, just leave now. Go outside in the gutter. Curl up and die. We welcome pain. We are pain. But we armor ourselves. Look around you. We are the city. Use your claws to hurt. Be one of us and pain won't touch you. You become the pain." He rose from his chair. "Are you ready to become the pain?"

He forced himself to stand, blood painting the floor a greasy red. He turned to the nearest Razor and struck him in the jaw with a leather gloved fist. The Boosters roared their approval. The answer was yes.

They stormed out of the building, claws exposed. They carried the kid on their shoulders. They would work their way across their city, heading towards a waiting ripperdoc, slashing and burning everything in their path. The cops stayed far away; no overtime bonus is worth messing with a Blood Razor initiation.

The hospitals would report thirteen casualties from the mayhem that night, all so that a fifteen-year-old kid could get his claws and join with his brothers. Before I left the nest, the Hack Man, cooling his jets with Smash, asked me what I thought of his family.

I popped the cassette out of my arm and stowed it in my bag. He could read about it on the Net, just like the rest of you.

—Walter Pickering, News 54

**Arasaka Security Corporation**  
**Password Please:** ΔΔΔΔΔΔΔΔΔΔ  
**Access Granted**  
**File Desired?:** Symbiotics  
**Please wait**  
 .....

**Symbiotics**  
**Symbiotics is the file name given to updates on Booster gang "Iron Sights" which is financed and controlled by Arasaka Security. Breakdown follows:**  
**Gang members: 43**  
**Enhancements: Varied**  
**Location: Night City**

**The following report compiled by Rachael Tyroll.**  
 .....

In accordance with my assignment, I met with said Booster gang at designated meeting place. Upon their arrival, they proceeded to scan me for weapons and other noticeable cybernetics. When they were assured that I was in fact a representative of Arasaka, the leader was brought out from a nearby bar where she had most likely been watching the initial encounter.

The first words out of the leader, who calls herself Brandywine, indicated to me that the gang obviously does not relish the idea of being a pawn for Arasaka, but resigns themselves to this stature because of the money we input into the gang. She then asked my purpose for calling such a meeting. Upon my telling her that Arasaka wished me to accompany the gang for a week to get the full scope of their activities. I was grabbed from behind and someone else threatened

See next page

my life with several sharp blades protruding from their hands. These weapons, which are illegal, go by the street name of "Rippers," and, judging by their looks, I would estimate that they will do just that to human flesh and bone.

The gang's initial hostility stopped cold when I firmly told them that killing me, or even refusing to let me accompany them, would result in immediate stoppage of funds provided by Arasaka. It is my impression that the members of this gang hate their own humanity as well as other people's. This is further reinforced by my observation that the gang members that are held in the highest esteem are the ones that have the most metal meshed with their bodies. In my judgement, the members of this gang can easily be controlled by our organization by simply controlling their money supply to buy new cybernetics.

The week I spent with the gang proves to me another theory that I had postulated: The gang not only hates humanity [which, in itself could be reasoning for its existence], but also likes to hurt, mutilate and kill others for what would seem to be the pure pleasure of it. These two factors lead me to the conclusion that the members of "Iron Sights" are all suffering from cyberpsychosis, and terminating our ties with them in the near future may be the best solution for all parties.

- Rachael Tyroll 9/1/20

# GANG VIOLENCE ERUPTS ON NIGHT CITY STREETS

*By Bes Isis*

In the early morning hours seventeen youths were killed in yet another Boostergang confrontation. Street sources say that a group of the Iron Sights gang were gathered at a bar known as Rainbow Nights when they were confronted by the red-robed Inquisitors. After a brief argument, fighting started, and when it was all over there were seven dead Inquisitors and ten dead members of the Iron Sights.

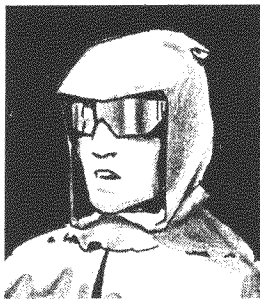

When we finally were able to reach the leader of the Inquisitors, who has asked that his name be withheld, he had several things to say about today's and other related incidents.

"In the midnight hour, when the sound of footsteps on the pavement strikes fear within your heart, the Inquisitors will be there to judge you. Tonight's example, the attack on the heretics known as the Iron Sights, is just the start of a new order that is coming to be. A new order that will be led by the Inquisitors.

"I stand here before the public not to preach of impending doom, but rather of judgment. Judgment that will be rendered by the Inquisitors. For most of the public, they have nothing to fear, but there are some out there that should think about their sins, and how they will soon be punished for them.

"To further the impact of this statement, I need only point out the case of the heretical members of the Iron Sights. They, like anyone else who has molded unnatural machinery into their God-given flesh, will be struck down to the last person by the Inquisitors. If that is not clear enough, then let me rephrase it: if you have no metal infused with your body, you are safe. If you have voluntarily undergone such blasphemous melding, then beware. The Inquisitors are here to judge you."

Although he would not reveal his identity to the public, the head of the Inquisitors is thought to have some older, no longer believed, religious background, which can be seen as the cause for his slightly different views on today's society. Whatever his reason may be, the head of the Inquisitors has given his warning to the people of Night City.

On an ending note, it must be pointed out that the chief of police for Night City was reluctant to answer questions regarding his plans for controlling the Inquisitors, and other gangs that threaten the citizens of this city. In fact the only thing we could get out of him was, "No comment."

Sound familiar?



*First Person***One Night with the  
TRAUMA TEAM**

**Rich "Meatball" Cramer M.D.,  
Dispatcher for Lifeline Trauma Inc.,  
Night City Branch #23**

**Transport: P&W modified A.V. 4E  
impact rated to threat level 7  
Crew: 5: 2 Med, 2 Solos, Driver/  
Gunner**

6:30 : Early call. Responded to warehouse district. Patient victim of Booster skirmish. Open chest. Trauma to liver, pancreas. Two collapsed lungs. Blood PH four over norm. Patient flatlined. Unable to revive. Removed model K-100 cyberarm with combat options for compensation. Suggest placing half of resale into company Christmas fund as per norm.

9:47 : Broken card alert at Hari Kiri Sushi restaurant. Corp patient found choking on piece of squid. Administered swift slap to back and dislodged foreign object. Read patient list of response charges. Patient became hostile and threatened lawsuit. Added surcharges. Patient pulled firearm, forcing Solo to fire in self defense. Patient revived and brought to Med Center. Suggest cancelling account after payment of bills.

11:23 : Solo down on grounds of Raven Microcyb Inc. Corp security became hostile and refused to allow extraction procedures of patient, claiming first rights due to Corporate Espionage Act of 2009. No one in team had ever heard of the Act, and in accordance with standard procedure, we continued with extraction. Raven Inc's. lawyers should be in contact concerning deaths of six security personnel who were in path of

AV-4 upon departure. Patient revived and charged extra for ammo costs and company lawyers fees.

14:15 : Firefight in inner city. Two

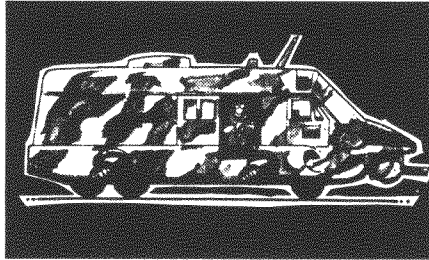

broken cards. Upon arrival discovered a team from R.E.O. Meatwagon Inc. in process of loading carded patients onto their unit. Following company policy on "meat jumping", we warned them off over loudspeaker. R.E.O. team opened up with small arms fire. Team R.N. Chestly Whitestone took the initiative and released napalm canisters. Resulting explosion cost lives of both the patients and the R.E.O. team. However, Nurse Whitestone's quick thinking saved company's and team's reputations. Suggest that we sue R.E.O. Meatwagon for costs of patient accounts and munitions expenses.

15:55 : Broken card call at Grand Illusion Dance Hall and Bar. Subject patient one Rockerboy, Kerry Eurodyne. Patient was in good health, but was under assault of young female fans. Dispensed teargas and waded into the fold. The grateful Mr. Eurodyne billed the cost of extraction and a new set of clothes to his studio's account and gave us a healthy tip. Since the teenyboppers seemed to enjoy the free-spirited chaos, I doubt the company need worry about lawsuits from irate parents.

16:30 : Team members attacked in bar during rest break between calls; shotgun-wielding Booster attempted robbery. Criminal was dispatched by team security leader, Jazz Tobias. Criminal flatlined from small arms fire and set off cybernet Lifeline response. Unable to revive. Suggest forfeiture of advance fees on account along with all personal effects. Due to amount of cyberware on patient, it is possible that she was in first stages of cyber psychosis.

17:40 : Net call to alley behind Night City chapter of Elks Lodge. Patient identified as DMS Vid actress Samantha Horn. Apparent overdose on mixture of 'Dorph and Slam. Patient revived. Dispatcher instructions followed to return patient to DMS studios. Team ambushed while on approach vector to DMS pad by three AV-4s bearing R.E.O. Meatwagon markings. Took evasive action. Main stabilizers holed during fire exchange. DMS anti-air defenses opened up at range of 300 yards scattering R.E.O. vehicles, one of which crashed over the financial district during retreat. Patient delivered after payment of hazardous duty fees and the promise of a night on the town with the chief surgeon. Have taken the liberty of placing all Lifeline teams on Class I alert. Counter all R.E.O. personnel and vehicles "with extreme prejudice". See supplemental report on incident and vehicle damage.

19:00 : Finished shift and returned vehicle to pool. Overtime and hazard duty pay logged with dispatcher. Team placed on two day paid layover while repair of vehicle in progress. Heavy weapons issued from Lifeline armory. Fixers contacted to deal with R.E.O. personnel. Team will remain together until incident blows over. For emergencies, contact team via Net passcode "Stitch In Time". . . . .  
. . . . .End of Report. . . . .End of Report. . . . .

# SCREAMSHEETS

IN THE 21ST CENTURY, THERE'S A LOT OF WAYS TO GET THE WORD. BUT THE BEST IS FROM A SCREAMSHEET— A COMBINATION FAX-NEWSPAPER, DIRECT LINKED TO THE DATABASES OF THE WORLD MEDIACORPS.

SOMETIMES A SCREAMSHEET IS JUST INFORMATION; A CHEAP THRILL FOR THE BRAINBURNED. BUT SOMETIMES, THERE'S ANOTHER STORY; A DEEPER MEANING LURKING LIKE A SHARK JUST UNDER THE SURFACE; A SCRAP OF DATA THAT LEADS TO A NEW ADVENTURE, JUST AROUND THE TURN OF A PAGE.

HERE ARE TEN VISIONS OF THE EDGE.

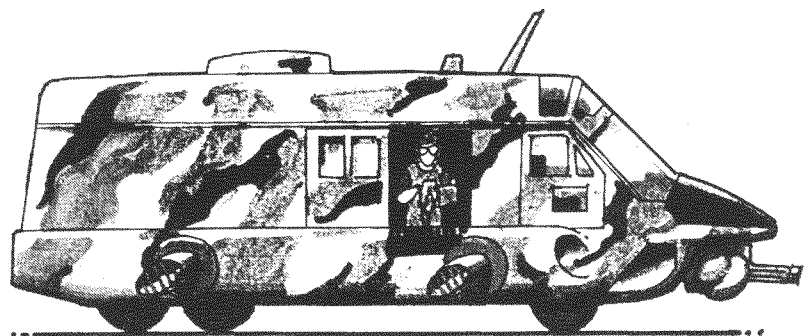

**SCREAMSHEETS**

WRITTEN BY: MIKE BLUM

ART DIRECTION: JANET PIERCY & TED TALSORIAN

DATABASE: WORLD NETWORK NEWS & NETWORK 54

SCREAMSHEETS™ 1990 R.TALSORIAN GAMES, INC.  
© 1990 R.TALSORIAN GAMES, INC. ALL RIGHTS RESERVED.

# NIGHT CITY TODAY

SEPTEMBER 29, 2020  
VOLUME CCVI, No. 28

## PETROCHEM REACTS TO BIOTECHNICA PGE ANNOUNCEMENT

**Dallas, TX** – An unnamed spokesperson for Petrochem provided a dramatic statement for reporters and industry analysts subsequent to Biotechnica's disclosure of the new PGE enzyme. "We believe that 6 months is not enough time for proper tests to be done on this engineering product. The possible biohazard is enormous, especially considering that the Russians produce 10% of the world's wheat and corn. If some unexpected side effect were to diminish or eliminate their agricultural output, massive famines could result."

## MIDWEST ROAD CONDITIONS TODAY

SPONSORED BY PETROCHEM

*"Without Petrochemicals, life as we know it would be impossible..."*  
[excerpts]

...Interstate 40 eastbound closed near Fort Smith, Arkansas for bridge repairs...traffic on Interstate 35 is slowed by a southbound nomad convoy in Lyon county, Kansas...U.S. 81 near Enid, Oklahoma has been closed due to a toxic waste spill-route not likely to be opened today...up to one hour delays on eastbound Interstate 44 near Tulsa due to road work...slow going on the Indian Nation Turnpike south of Henryetta due to smoke from a fire at a tire dump...severe flooding reported in several Gulf states, and along the Mississippi River...acid hail reported around Omaha...highway sniper incidents ongoing at Fort Worth have halted traffic...drifts of migrating mutant catfish reported on roads west of Shreveport...

## BIOTECHNICA ANNOUNCES IMPROVED PLANT GROWTH ENZYME

**La Jolla, CA** – In a dramatic announcement today, officials of Biotechnica revealed the development of a new plant growth enzyme (PGE), which promises to boost production of grains and cereals by 10%. The enzyme, developed by researchers working here at the Biotechnica Research Facility, will be undergoing formal tests by the USDA soon. Biotechnica expects the PGE to be in distribution by next year.

Stock analysts expect Biotechnica to rapidly gain in value; agriculture giant Petrochem is expected to drop, (see page C-30)

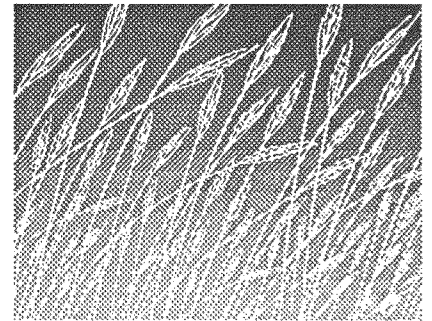

## EYE ON THE MARKET:

*Night City Today* Examines  
the Best in Available  
Equipment.

**Today: The Yakurichi-Ural  
BR70 Heavy Transporter**

With: Full Cyber interface •  
Nav System with NAVSTAR®  
Guidance Package • Radar •  
CB Radio • Sleeper cab for  
two • Powerplant: Rolls Royce  
CB40V • 5,800 HP • 110  
highway/130 boosted.

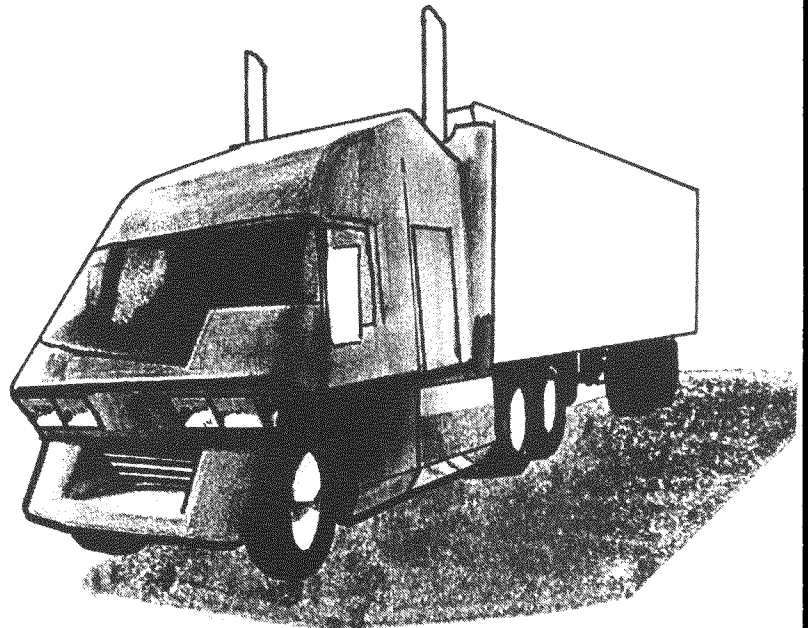

## Scenario 1:

# Open Highway

### Players' information

The players, while on the West Coast, are approached by Biotechnica about driving and escorting a tractor-trailer rig loaded with PGE and test items from their site at La Jolla, to a USDA facility in near Nashville, TN. The team would be required to cover 1900 miles in 36

hours. Biotechnica will reveal that Petrochem is trying to get their hands on some of the PGE, and the team should expect trouble. In the Mid-western states, where Petrochem owns vast pieces of the landscape, the corporation can pretty much do what it wants.

The tractor is a Yakurichi-Ural BR70, with a cyber interface, nav system, CB radio, radar warning receiver, 2 zero/zero ejection seats, automatic fire extinguishers, road surface sonar for the active suspension, hazard warning/auto braking radar in the grille, air conditioning, stereo system, sleeper cab, winch, and 70 SP kevlar fibreglas body, with 30 SP polycarb windows. The power plant is a Rolls-Royce CB40v turbo-compound 64 liter V-12 variable geometry free piston engine acting as gas generator for 4 modified Teledyne CAE J402 turbojets, burning a mixture of nitro-doped high octane gasoline, meta-alcohol, ether, and acetone; a tank of inhibited red fuming nitric acid is available as a boost oxidant, for up to 25 minutes. Max rated (unboosted) at 5,800 shaft horsepower; normal fuel capacity 1200 liters.

Top speed is 110 mph on highway (130 boosted), 40 mph off-road (50 boosted). Length 8m, width 3m, height 3.1 m. Four extra saddle tanks provide about 2100 miles range total. Total cost, if you want one, is about 120,000 eb. The trailer is a Freyhilf armored van body (90 AP), with an alarm system, airconditioning

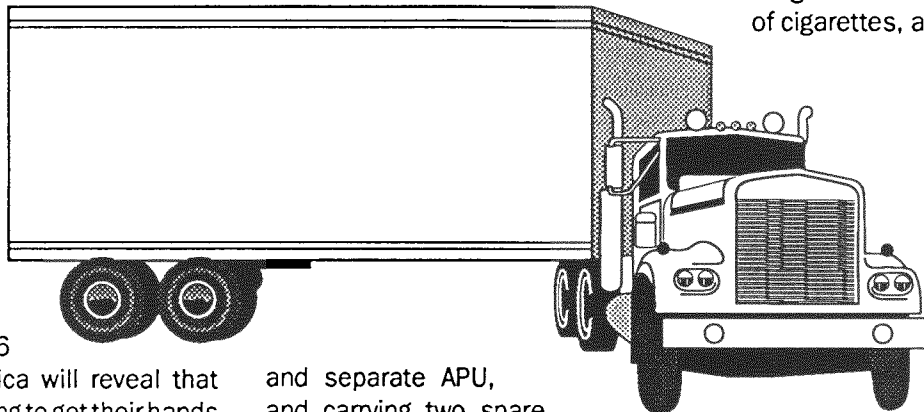

and separate APU, and carrying two spare tires (which will also fit the truck). Various repair tools are in workboxes on the tractor. A hatch has been installed on the top of the sleeper cab.

The team will also have the use of two anonymous Toyo-Chevrolet sedans as scout/escort vehicles. Each of these has been fitted with a CB radio and "police interceptor" performance options (treat as 'sports cars'). However, neither is armored.

The cargo consists of 20 plastic drums of plant growth enzyme, 280 sacks of hi-yield fertilizer, and 2 crates of test instruments.

The team members will receive 1000 eb each at the destination if the cargo is delivered intact.

### Ref's notes:

Biotechnica is using the players' team as a decoy. The PGE in their truck is actually an early experimental version that went subtly wrong. Biotechnica is hoping that Petrochem will a) be diverted away from the real

shipment, and b) if the fake PGE is stolen, Petrochem will waste a few months figuring out what it is. To further this goal, Biotechnica has fitted the tractor with a satellite transponder, and will leak the location of the truck (through independent netrunners and cutouts) to Petrochem once or twice during the run. The transponder is an anonymous-looking box about the size of a pack of cigarettes, attached under the

dash board. Thus, the characters can expect to be intercepted a couple of times by cars, helicopters, roadblocks, corporate troops, etc.

If the armor over the fuel tanks on the Yakurichi-Ural tractor is penetrated, the remaining fuel in that tank may self-ignite. Five of the tanks contain the gasoline/alcohol/ether/acetone portion of the fuel, 300 liters each tank; the sixth tank contains 300 liters of red fuming nitric acid.

The real shipment is being sent by entirely different methods and routes, guarded by Arasaka hired mercs.

Biotechnica will grudgingly pay the characters if they successfully reach Nashville, however. Nobody wants a reputation for shafting solos, after all.

# NIGHT CITY TODAY

October 6, 2020  
VOLUME CCVI, No. 29

>CRIME  
>NIGHT CITY STALKER  
>RECENT: 3 WEEKS : NIGHT CITY

## BRIGHTMAN RELEASED FROM PRISON

**Night City, CA** – After spending 17 years in prison, Joshua Brightman was released yesterday at the end of his sentence. Suspected of being the “Night City Stalker,” Brightman was never convicted of any of the 32 murders committed by the Stalker. His was imprisoned for kidnapping and attempted murder, after a widely-publicized trial. Many believe, however, that Brightman is indeed the Stalker. The former electronics store manager is now 39 years old.

Threats against Brightman’s life have already been received, and his stated intent of returning to Night City has already alarmed citizens’ groups. Police spokespersons, however, were unconcerned, stating, “We deal with cyberpsychos every day who make the Stalker look like Santa Claus. I expect Mr. Brightman will find the streets are a bit tougher than he remembers.”

In related news, Federal prosecutor Mel de Costa verified that charges will not be brought against Brightman under various Federal firearms statutes, as the statute of limitations has expired. Brightman was found in possession of a sizable arsenal at the time of his arrest, but charges were not pressed at that time. “The

State of California dropped the ball on the prosecution of Brightman,” said de Costa. “We were assured at the time that he would be convicted of multiple murder charges with special circumstances, and so did not go ahead with the weapons charges. By the time the trial ended, our resources were spread pretty thin in various Central American “International Drug-Lord Statute” prosecutions, and so a case was never made.”

>BRIGHTMAN  
>RECENT: 2 WEEKS : NIGHT CITY

## SUSPECTED “STALKER” BUYS CYBERLIMBS

**Night City, CA** – This reporter has learned that Joshua Brightman, recently released from prison, and suspected of being the “Night City Stalker,” has undergone extensive cybernetic replacement surgery in the last few days. The exact nature of his enhancements are unknown, but he has spent over \$3000 on hardware alone.

Night City police spokesperson Claude Maxwell would only com-

**WANTED:** persons with experience in archaeology for work on a corporate research project. Preference given to specialists in early British Megalithic sites. Top \$\$\$\$. Contact Hudson Assc. 1-212-555-6798

**BODY IMAGE**  
When only the Best will do...  
1-417-555-8900

**Interfaced.**  
**The Master Hackers**  
For all your NET Security Needs.  
Contact DF 562-128, code 1226,  
for a free evaluation.

ment, “As long as Brightman doesn’t purchase any illegal cybertech, we can’t touch him.” When asked if the NCPD planned to monitor Brightman’s cyberware purchases, Maxwell replied, “No comment.”

>CRIME  
>MURDER  
>NIGHT CITY  
>CURRENT: CURRENT:

### CRIME BEAT

The consolidated crime report for last week reads as follows: 72 murders, up 2 from the same week last year; 190 attempted murders, down 6; 590 felony assaults, up 12; 15 kidnaps, up 1; (see page C-6)

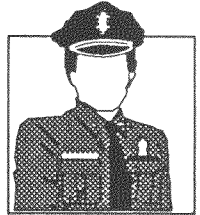

**WATCH NEWS 54 WITH  
DONDRE WHITFIELD  
8:00 ON CHANNEL 54.  
THE  
MAXIMUM  
INFORMATION  
CHANNEL**

## Scenario 2:

# Back from the Penalty Box

### Players' information

The characters are approached by Carole Medina, a small time fixer, who needs protection. She has recently gained some evidence which would prove that Joshua Brightman is indeed the Night City Stalker. She is trying to get Network News 54 and the World News Service to bid on this evidence, but this will take a day or two for the deal to go down. In the meantime, she is worried about both of the corporations trying to get something for nothing, and also worried about getting a visit from the Stalker. She will pay 500 eb each for up to 6 characters to keep her safe for two days. The characters can choose where to set up their "safe house," as long as it is within either the Downtown, South City, or Charter Hill areas. Each of the news corps will want to send someone around to inspect the evidence before bidding.

Medina herself is armed with a short-barrelled .357 Magnum revolver.

### Ref's notes:

Brightman is sure enough the Night-stalker. He has already armed to the teeth and then some, and has committed a couple of murders in the

past week. He was a tech freak before he went to prison, and has followed the development of cyberware with a calculating intensity. He has gone all-out on cyberware purchases: bodyplating, cyberlimbs, pretty much every kind of legal and illegal cybertech. He does not suffer from cyberpsychosis, as such: he was a psycho long before cyberware was available. Brightman is preternaturally stealthy, and delights in "spooking" his victims before he finishes them. He has a very good knowledge of electronics of the more simple kind: phone and power lines, for example. As the Stalker, he carries a good supply of big guns and knives, and wears black coveralls and a balaclava.

The two news corporations will each send, at different times, an investigator over to view the evidence Medina has gathered (a shoebox full of gruesome photographs). For the next 18 hours or so, the two corporations bid and maneuver. Eventually, late in the evening of the second day, one corporation will put up the winning bid; an executive for the other, in a fit of spite, will call Brightman and tell him where Medina is, and why he should pay her a call.

Six hours will pass while payment details are arranged and the corporation sends over a team to collect the evidence. During that time, Brightman will strike...

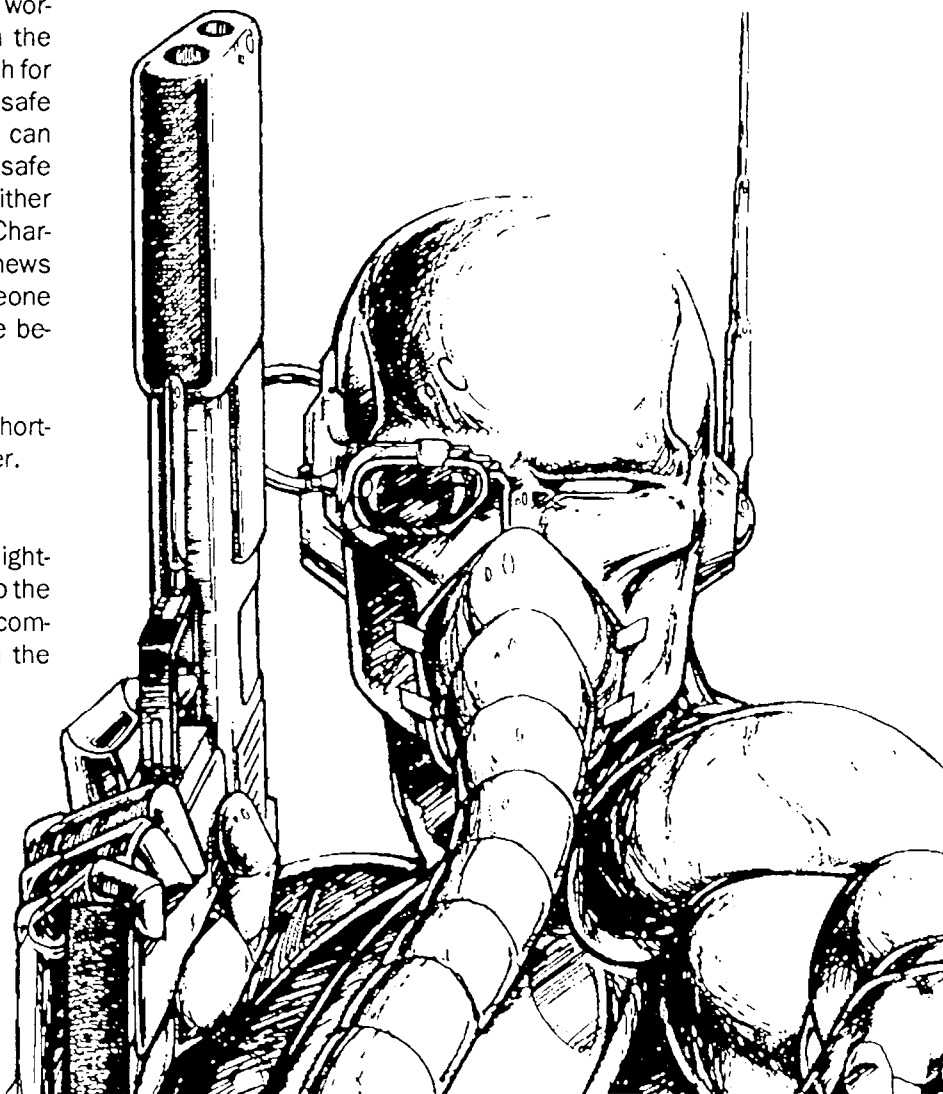



# NIGHT CITY TODAY

October 13, 2020  
VOLUME CCVI, No. 30

## REPORT

### MEDIA: DMS CRACKS DOWN ON COMPETITORS

Los Angeles, CA — In the wake of FCC's "La Rosita" ruling, Diverse Media Systems has gone after unlicensed competitors with vigor. Lawsuits, jamming, ECM, and physical harassment have all been employed in an aggressive effort to counter the 'independents' programming. Other mediacorps have also taken advantage of the new loosened rules, but only DMS has gone to the acceptable limits...some would say past them.

In this article, we will examine the latest actions by DMS, and try to uncover the reasons (cont'd page C-2)

>KRAB

>RECENT: CURRENT: LOS  
ANGELES

### JOSH CARBONELL MAKES WAVES IN THE OCEAN

Media renegade Josh Carbonell is tweaking the nose of the corporate bigwigs at DMS again! His pirate station KRAB, operating off of an old

oil platform in the San Pedro Channel, has broken several major stories lately; two of those stories showed DMS's own reporters in a very bad light. In the "Imperial Valley Genetic Scandal" series, KRAB reporter Julian Morales revealed that DMS's own investigators were involved in the coverup of a major biohazard waste site. In his own "A Deeper Look" series, Josh himself has done follow-ups on stories run by DMS and Network 54; DMS particularly came out looking foolish. KRAB has also become a fad favorite music station in LA, as well.

Josh attributes his success to "sex, drugs, and the worst taste in music west of the Rockies. I let my DJs do their own programming, and expect my reporters to kick (cont'd page C-15)

>MORE:

### CHIPPING AWAY

Since the summer of 2011, Elay residents have been exposed to dangerous radiation — specifically, the transmissions of pirate radio station KRAB. The station produces a signal strong enough to reach 37 million Angelenos — though it has also been off the air for intervals of up to a week. The wild and wooly mix of political rock, "unconventional" news, and other unexpected programming elements have made this station the street box favorite. DJs Montjoy Singh, Renee Dillon, and (see page C-15)

>CALHUA-MEXICA

>RECENT: 2 WEEKS: LOS  
ANGELES

### BOOSTERGANG TRASHES INDEPENDENT RADIO STATION; 3 KILLED

Early this morning, a local boostergang raided a small pirate radio station, operating as Radio Free Burbank, and destroyed their studio and mobile units. Three people, including the station's owner, Mark Springfield, were killed. The station, which had been operating on various FM channels, was noted for its unique musical choices, and hardhitting investigative reporting. Local police had no comment as yet on the attack.

The station had been broadcasting by stealing airtime on corporate station transmitters, using sophisticated computer infiltration techniques. They had no transmitter of their own.

The boostergang, identified as the Calhua-Mexica gang, has been linked in the past with the DMS mediacorp. However, corporate spokespeople denied any knowledge of such a link. Representatives of the Calhua-Mexica gang, when contacted by this reporter, gave a rambling statement which seemed to indicate they felt generally insulted by Radio Free Burbank, and had decided to take action on their own.

## Entertainment AT CLUB RETRO

FOR THE BEST INBIOSCUPT  
RECREATION AND  
CABARET. NOW  
APPEARING, "HITMAKERS  
1989"  
142 S.DELANY, NIGHT CITY



### Scenario #3:

## Pirate Radio

### Players' Information:

The characters are recruited by KRAB's Josh Carbonell to guard his studios and staff from DMS and their thugs. He fully expects to receive a visit from the Calhua-Mexica gang in the near future. He will pay 100 eb a day, each day, plus room and board, for at least a month's work. You also get to pal around and get stoned (off duty) with a bunch of cool DJs, underground media personalities, and visiting musicians.

The actual KRAB studio is on a barge, several kilometers from the old oil rig which carries the KRAB transmitter. There is a tight beam microwave link from the barge to the oil rig, and all of the KRAB correspondents use cell-phones to call in their stories. Josh does not have a lot of faith in this system keeping DMS from finding his studio.

The barge is in the middle of a raft-city, covering nearly 50 square miles, which floats just off the shores of Los Angeles. The residents are poor, homeless, ethnically disadvantaged, undocumented, and/or avoiding the law. Nearly 120,000 people live out here, on old barges, small ships, pontoons, jury-rigged rafts, and just about anything else that floats. There are twisting, narrow "canals" of open water running through the raft city. The Coast Guard has long ago given up trying to disperse this mess, and content themselves with keeping the rafts out of the sea lanes and harbor. The Rafterers are essentially another variety of "Nomads" for *Cyberpunk* game purposes, though the raft-city does not wander around.

At any time, there will be at least a dozen NPCs on the KRAB barge: Josh, 3 Techs who maintain the massive kluge of radio gear at the station, a couple of Medias who act

as producers/writers/sound engineers for the station, a Rafter cook, a couple of DJs or reporters (more Medias, or possibly Rockerboys), and some underground media/music personality here for an interview (or possibly to help Josh defend the place), along with his or her band (and possibly a groupie). Most of these people will be armed with various light pistols.

The Techs have mounted a couple of low-light cameras on the barge mast. A warren of rooms has been created out of sheet steel in and on the barge; the decor is best described as "funky."

A couple of speedboats and a 'utility' outboard owned by the station are normally available for travelling around in the raft-city, or to Los Angeles.

The Techs, Josh, and some of the Media-types normally play lots of poker at night.

### Ref's Notes:

DMS will indeed find the actual location of the studio within a few days, and will send their goons the Calhua-Mexica gang out to destroy it. They will arrive in 6 stolen speedboats, and a stolen Bell-15 Airogyro. Each boat will be carrying 3 boosters, the Airogyro only 1. Lots of automatic weapons, a couple of grenade launchers, and a few Molotov cocktails will round out the bad guys weaponry. The booster in the gyro will play "bomber." All of them have reflex boosters and smart guns, at least; other cyberware is certain to be installed.

The Rafterers around the barge may join in and help the players, if things seem to be going poorly; they have no love for the boosters, and Josh has been a good neighbor.

If the players manage to repel the assault, Josh will offer them occasional employment as 'backups' for his reporters.

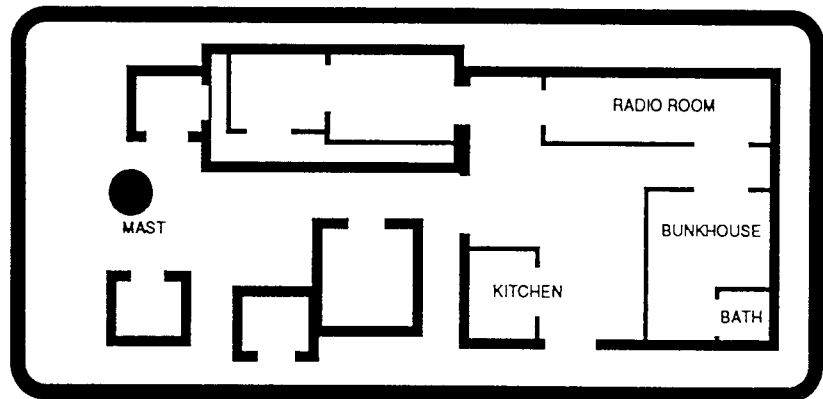

## THE BARGE

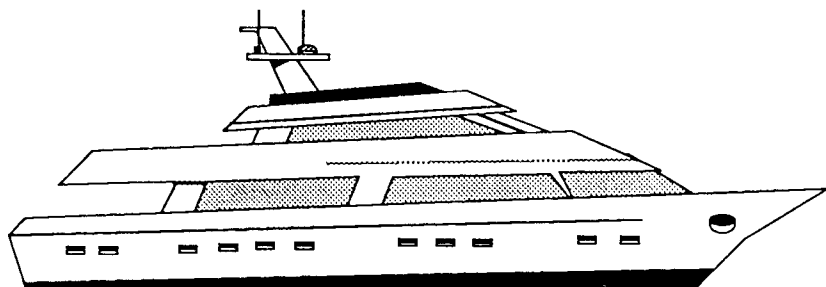

# NIGHT CITY TODAY

October 20, 2020  
VOLUME CCVI, No. 31

## BOOBYTRAPPED CYBERWARE ON THE STREETS!

**Night City** – In a bizarre twist on the problem of black market cyberwear, this reporter learned today of a flood of sabotaged cyberware which has been unleashed in this city. Apparently sold to unsuspecting boosters, these prosthetics contain chips programmed to cause violent incidents.

No pattern has yet been detected to the reason for these incidents. Several boosters have strangled themselves with their own cyberarms; others have fired on police cars or patrol officers (with less reason than usual). Some have been driven into cyberpsychosis with alarming speed, and others found dead with no apparent cause. Few of these incidents have been investigated fully by the police until recently.

Few boosters have survived their rebellious cyberware; none were willing to talk to this reporter. It is believed that the cyberware involved was purchased on the street, and outwardly at least resembles various cheap popular brands.

## REWARD FOR BRINGING DOWN SABOTAGE CHIPWEAR DEALER!

**Night City (AP)** – In an unprecedented announcement, the Night City PD, the heads of three major boostergangs, and an association of local street clinics revealed a

reward fund for “bringing to justice” the persons responsible for the sabotage cyberware being sold in Night City. The fund, standing currently at 5000 eb, was contributed to by the Police Benevolent Association, the major boostergangs, and several street clinics. Detective Arnold Heller, speaking for the PBA, said, “The patrol officers feel there are enough risks to working the Combat Zone, without these human time bombs on the street. We are hoping some responsible citizens can help us put an end to this problem. Of course, people should be aware that this is a hazardous situation, and act accordingly.” Representatives for the clinics and gangs endorsed Detective Heller’s comments; “Razorface,” head of the Grimmers, added, “Yeah, what s——d said, goes for us, double.”

Night City DA Bernard Moon, when



BERNARD MOON

asked about this apparent invitation to “vigilante justice” by the Night City PD, said, “Naturally, we have to carefully enforce any

laws broken by anyone, even while doing a public service. However, it is also true that there is considerable leeway for my office to decide which cases to prosecute. Our caseloads are already staggering! Without committing myself to anything, I can certainly say that any mitigating circumstances would be taken into account before a decision was made on whether to file charges.

“As for the reward offer, there are certainly precedents at both the state and federal level for such action.”

**BODY IMAGE**  
When only the Best will do...  
1-417-555-8900

## GANG VIOLENCE ON RISE IN NIGHT CITY

Several major battles have taken place between Night City boostergangs, all related to the sabotage chipware being sold in the streets. Some of the battles were caused by accusations of complicity in the distribution of the corrupt cyberware; others were apparently provoked by the cyberware itself. So far, 27 gang members, 8 bystanders, and 3 Night City policemen have been killed in these incidents.

In response to this violence, the anti-prosthetics group, the Inquisitors, has been staging protests at City Hall Plaza, calling for stricter enforcement of black-market cyberware laws.

## METALHEAD

Your Maximum Metal  
Force in the NET.  
Night City LDL 1442-92

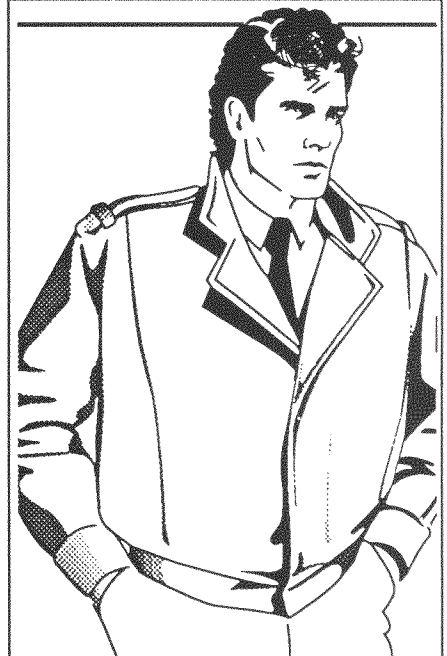

KELLY RHODES is  
**THE PROFESSIONAL**  
COMING IN THIS FALL ON  
**NETWORK 54**

Scenario #4:

## Armed & Dangerous

### Players' Information:

Here is a chance for the players to make some bucks, without an employer watching over their shoulder. The reward offer seems legit, and the characters would stand to gain some friends in the gangs, on the police force, and in the small clinics: not the worst friends to have.

Of course, first you have to find the dealers.

### Ref's notes:

For most of this scenario, the players will be using lots of Stealth, Shadowing, Human Perception, and lots and lots of Streetwise.

The sabotage chips are being made overseas, installed in standard cheap cyberware, and brought into Night City by the Inquisitors. They then sell the cyberware (at a loss) to boosters, who do most of the actual "retail" distribution. The boosters involved, mostly members of the

"Barons," have realized what is going on; but being particularly nasty boosters, don't really care as long as they don't get caught.

Eventually, the characters should be able to get the time and place of a meeting, where some of the "Barons" will meet their mysterious suppliers, and hand over cash for cyberware. The characters may want to bust up the party right there, in which case several of the suppliers will turn out to be Inquisitors in mufti. Or, they can follow the suppliers around, and catch them with their unsavory pals at whatever dive the Inquisitors call home. Either way, lots of heavily armed people will be mad at them for a short while; some will have lots and lots of cyberware, some will have none at all. 10,000 eb in cash and 10,000 eb worth of black market cyberware are being traded; most of the cyberware is sabotaged, but the money is fine.

Once the police and boostergangs have been informed of who is really responsible for the problems, the characters' troubles will be over. For the "Barons" and the Inquisitors, the troubles will be just beginning . .

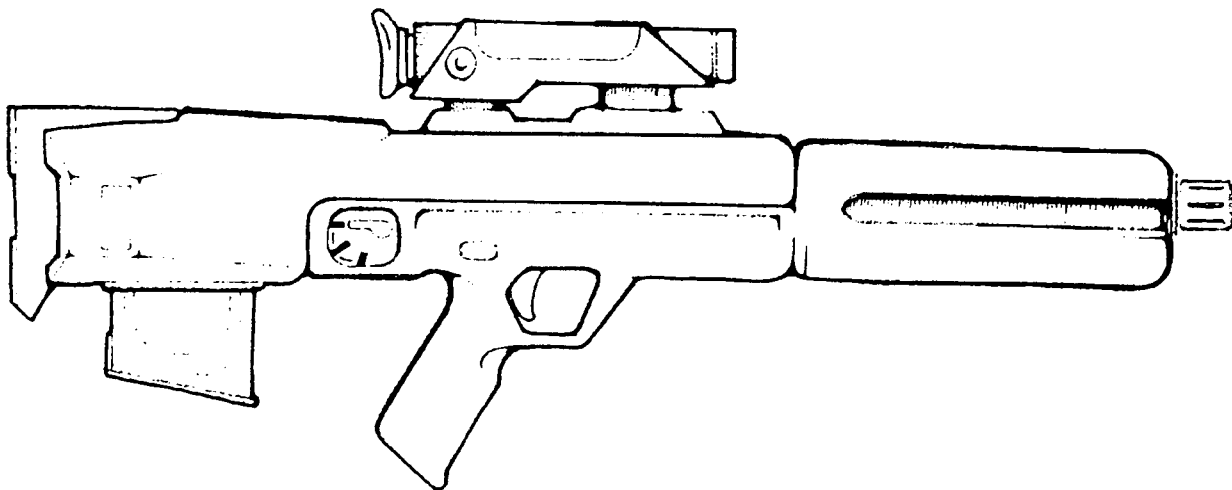

# NIGHT CITY TODAY

October 20, 2020  
VOLUME CCVI, No. 32

## NETWORK 54 ANNOUNCES CABLE AMNESTY PROGRAM TO END SOON

New York – Network News 54 announced today that, at the end of their 60 day amnesty program, they would be taking “harsh measures” to deal with illegal hookups. When asked about what these measures might be, company spokesperson Andrea Kugel replied:

“We will go after these people using every legal tactic available to



ANDREA KUGLE OF NET 54

us. These people are not paying their share; their neighbors should realize that. We estimate that if all of the current illegal hookups were converted to legal, paying hookups, rates to consumers could be decreased by as much as 12%!

“Our amnesty program is very simple. You just pay the standard 50

eurobuck connection fee—that’s it. Our installers are certainly under no pressure to disconnect — we would rather have happy paying customers. But if we have no other recourse, we will disconnect illegal or delinquent hookups as fast as we can.

“If you don’t want to reduce your rates, all you have to do is sit there. But if you want the possibility of lower rates, call our toll-free number 1-700-555-3465.”

## REPORT

### MEDIA: CAN NETWORK 54 DEAL WITH CABLE HIJACKING?

By Ed Andersen

In the wake of the announcement by Network News 54 of the upcoming end of their amnesty program, we have uncovered some interesting statistics. In a similar program undertaken last year by the City of New York, which owns its own cable system, the cost of the program exceeded the new income brought in by formerly illegal subscribers. In addition, 18 city cable employees were killed while disconnecting homes from the cable net; 3 persons were killed by cable employees returning fire. 20% of the disconnects were later discovered to be legitimate, paid in full cable accounts.

As most of these disconnects occur in poor neighborhoods, the disconnection teams are exposed to great risk to life and limb from gang activity in those areas as well.

In light of this, can Network News 54 really claim that our neighborhoods will benefit from this program? In our opinion, an extended amnesty program would better suit the public interest, and (cont’d page C-14)

### O'DOWD ELECTRO- STATIC BODYWEAR, CYBERTECH and SKINTECH CLEANING

SINCE 2007, WE'VE TAKEN  
THE TIME TO EARN YOUR  
TRUST.

1 (500) 99-CLEAN

Full Skin Job, with up to two  
Cyberlimbs, Optics realignment.

**\$209.95**

## Cable Employee Killed By Video Pirate

Night City, CA – An employee of Night City Cable, a local subsidiary of Network News 54, was killed yesterday while trying to disconnect an apartment in the South City district. The employee, Renee Wong, was pronounced dead on arrival at City Medical Center, having suffered multiple gunshot and stab wounds. The three other members of her disconnect team were also admitted to the hospital; one remains in intensive care, while the other two are in “fair” condition. Police have a suspect, Charlton Ompa, age 30, in custody. Mr. Ompa, an unemployed theater usher and a veteran of the Central American Wars, has plead not guilty to the charges of murder with special circumstances, attempted murder, possession of unregistered firearms, possession of explosive devices, assault with intent to do grievous bodily harm, possession of illegal cyberware, and resisting arrest.

Apparently Mr. Ompa objected to the Night City Cable team cutting his illegal hookup while he was watching the National Laser League playoffs.

### BODY IMAGE

When only the Best will do...  
1-417-555-8900

## Scenario #5:

# Giving the Public What They Want

### Player Information:

The characters, in need of money, have been hired as a disconnect team, and must clear illegal and delinquent taps off of the cable net. They will be paid \$25 for each connection which is "legalized," that is to say the customer starts paying, and \$10 for each connection dropped from the net.

The cable net is an optical fiber network installed originally in the 2000s. It carries video, high-rate computer data, and screamsheet pages. Fibres range in size from 1-1/2" diameter armored cables under the street, to 1/10" diameter risers entering the customers' homes. Taps may be present anywhere, but the likeliest taps are found along the shortest route from the tapper's TV set to the nearest legal cable.

There are six basic methods for locating illegal hookups:

- 1) calls to the "fink" line at Night City Cable; the characters will be provided with printouts listing all information gained from these calls;
- 2) electro-optical cable load meters, which can be clamped to the fiber optic cable to find transmission losses;
- 3) netrunning — against computer hookups;
- 4) physically tracing cables;
- 5) paying bribes, persuasion, intimidation, or other 'street' tactics; and
- 6) con games, such as going door to door with a "Viewer Marketing Survey."

The characters are issued Night City Cable ID cards, and are legally al-

lowed access to all cable company property — which is to say, the cables themselves. Of course, not everybody agrees 100% with this.

And then there is that violent minority — who, when their hookup is cut, or if they see someone just sneaking around, whip out a 12 gauge. And of course, poking around in the basement of big apartment buildings is a lovely way to meet boosters and worse.

The only legally sanctioned reply to this is "self-defense." Of course, from the company's point of view, public opinion is a whole lot more important than the law.

### Ref's notes:

Most of the people who have rigged illegal hookups are not going to give the characters any trouble — a few will even go for the amnesty program. On the other hand, a boostergang which loses their cable

signal just before the Big Game, a netrunner who loses his high baud line while making a dangerous run against a corporate mainframe, or a psycho who can't see his "Mayberry RFD" reruns, can all give the characters a hard time. Basically, nobody will be happy to see the characters.

On the other hand, Techs and Netrunners might welcome an opportunity to squirrel around in the cable company's computers, and rig their own little surprises on the net.





# NIGHT CITY TODAY

October 27, 2020  
VOLUME CCVI, No. 33

- >NOMAD BBS
- >DUSTVILLE CAMP
- >RECENT: CURRENT:

## CORPS HARASS FAMILIES AT DUSTVILLE

Well friends, the megacorps are at it again! A truckload of their goons came by the Dustville camp yesterday and tore into the folks there — trying to scare them off. The goons weren't giving out names, but it seems a friend of ours ran the Net: and she figures them for Petrochem's own brand of slime.

Now most of you already know from personal experience all about Petrochem, but just in case there are a couple of new folks on-line, I'll lay out the down and dirty about the kind of game these guys will be playing in Crow Canyon. Back about 15 years ago (see page C-2)

- >PETROCHEM
- >DUSTVILLE CAMP
- >RECENT: CURRENT:

## PETROCHEM RESPONDS TO RUMORS ABOUT DUSTVILLE "CLEANUP"

Dallas, TX – When questioned today about Petrochem's actions concerning the so-called "Dustville" camp in Ventura County, California, spokesperson Alan Valentine replied,

"The property in question is corporate property. We will enforce our property rights to the limit of the law. No further comment."

Petrochem has a reputation for fierce, some would say savage, responses to squatters and trespassers on it's corporate farms in this country. While the "Dustville" camp is on apparently worthless property, the corporation seems unlikely to cede any property rights in this case. Another confrontation between Petrochem and the nomads is shaping up...

- >DUSTVILLE CAMP
- >AS PROPERTY
- >SINCE 2000:10 YEARS:

## Crow Canyon Refinery Will Not Be Built

Ventura County, CA – In the wake of the merger between Western States Oil, Elf Aquitaine, Chevron, BP, and Royal Dutch Shell, several



major projects have been cut in order to pay bond fees associated with Ms. Ellen Trieste's takeover. Locally, this means that the Crow Canyon Refinery project will not go through — even though Western States Oil has already purchased 1800 acres of land.

Tonight at 8PM on DMS: see **HOGG COUNTY, TX**  
"A Laff Riot!!!" — Jevers Hence

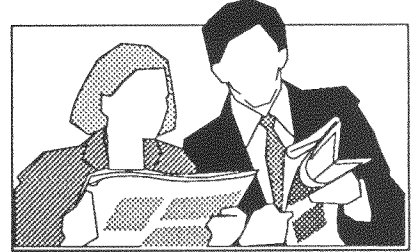

## CORPORATE REPORT

As of last download...EBM acquires Consolidated Factions by unfriendly takeover, analysts concerned...Leon H. Morgan III named VP of International sales for Genma Corp...WestTech stock falls due to chemical scare in South Indian Ocean...Petrochem under fire for alleged dumping in Texas facility...MetaLogical (pg. F-27)

## CRIME BEAT

The consolidated crime report for last week reads as follows: 106 murders, up 5 from the same week last year; 121 attempted murders, up 16; 42 felony assaults, down 25; 3 kidnaps, down 3; 24 rapes, down 18, burglaries 41 (see page C-11)



**WATCH NEWS 54 WITH DONDRE WHITFIELD 8:00 ON CHANNEL 54. THE MAXIMUM INFORMATION CHANNEL**

## Scenario #6: **Camping Out**

### **Player Information:**

The characters are contacted by their nomad friends (what, you say you haven't got any nomad friends? Every group has someone who has nomad friends!). The nomads need help protecting their camp in Crow Canyon from corporate harassment. They can pay \$30 a day, plus meals; but would really appreciate any characters who helped out of the goodness of their hearts.

About 200 people live in the camp, named "Dustville." Of these, 80 are children, and another 40 are too old or disabled to do much useful work. There are half a dozen old school buses, and a couple dozen beat-up old cars, pickups, RVs, and motorcycles at the camp. Several of the buses are in need of major repairs.

Every day, about 100 of the Nomads drive down the unpaved road which leads to town, looking for ways to get money, food, and water for the camp. The small creek in Crow Canyon is dry in the summer, and the valley is very dusty (hence the name "Dustville"). A friendly local has promised to loan the nomads an old well drilling truck for a day or two, so they won't have to carry water into Crown Canyon.

The nomads have enough weapons to arm 50 people with pump shotguns, lever action carbines, and pistols. Body armor is very scarce.

### **Ref's notes:**

In 2008, Petrochem wanted to expand a business park being developed in San Bernardino County, about 100 miles east of Crow Canyon. Unfortunately, the area they wanted to expand into held a toxic waste dump, built in the early 1980s. Petrochem worked out a deal with the county and state to move the dump contents to a "better" storage

site out of state; but instead, moved 70,000 cubic yards of contaminated soil to the Crow Canyon property. At Crow Canyon, the waste was covered by a couple of feet of local topsoil.

Petrochem pretty much ignored Crow Canyon after that — until recently. Some bright boy in the local office realized that "Dustville" was located on a nasty corporate secret, and has decided to move them off before they stir things up better left buried.

Petrochem is keeping an eye on what happens in the valley with a couple of remote surveillance drones flying at high altitudes. They are both very small and quiet.

Toxic waste laws have been relaxed quite a bit since the 20th century, but this dump is such a horrid mess that even Petrochem would be embarrassed. Proper disposal costs for the waste materials involved would run into the tens of millions of dollars.

A few of the people in the camp have been having headaches and feeling nauseous — this is nothing yet. So far, the Nomads have had "barely any" exposure.

As soon as the well drilling begins, the bit will hit something big and hard. A little shovelling will reveal a broken concrete block, originally some 10' on a side. 4" tall letters set into the concrete read:

DANGER  
HEXACHLOROCYCLOPENTADIENE  
POLYCHLORINATED BIPHENYL  
POLYVALENT CHROMIUM  
NITRIC ACID

TOXIC MATERIAL DISPOSAL STRUCTURE  
300' X 300' VAULT  
LOCATED 50' NORTH OF THIS MARKER  
SITE 480 — ESTABLISHED 1982

This stuff is bad, boys and girls! If further drilling is attempted, a pungent oily yellow liquid will be found permeating the soil a few feet down, along with the crushed and rusted remains of 55 gallon drums. Everyone in the camp will get headaches immediately just by exposing this glop.

The yellow soup is toxic, mutagenic, carcinogenic, teratogenic, and generally dangerous. Symptoms for increasing exposure include nausea, hemorrhage, and death.

A trivial amount of research will discover that Site 480 was supposed to have been moved out of state from San Bernardino County by Petrochem.

Once Petrochem figures out (from the RPV cameras) that the Nomads are digging up the toxic waste, they will scramble to eliminate the Nomads. Within 20 minutes, 10 AV-4s, each carrying a 10-man assault squad, will converge on Crow Canyon. They will attempt to block the road, and massacre the Nomads.

The unpaved road into town is about 3 miles long — anyone who reaches town can be considered safe for the moment. Note that the Nomads do not currently have nearly enough transport for everyone at the camp to ride a vehicle.



# NIGHT CITY TODAY

November 3, 2020  
VOLUME CCVI, No. 34

## ATTACK ON HIBERNIA OILFIELD

### Nearly 20 Killed

**St. Johns, Newfoundland** – The “Hibernia” oil production platform, located 200 miles southeast of this Canadian city, was heavily damaged

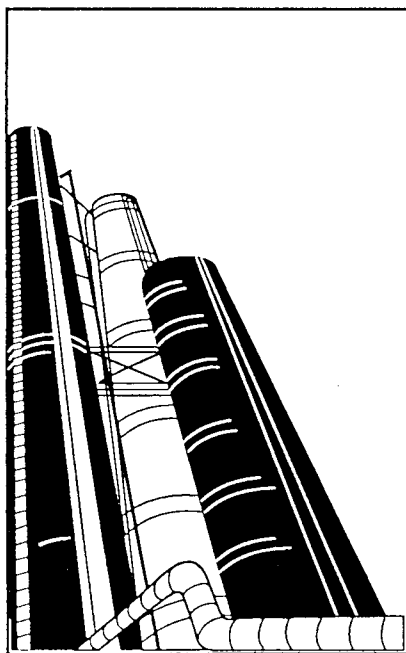

today by a missile attack. 17 people are confirmed dead, and another 10 are missing. No estimate of the monetary damage was available. The platform is at the center of a network of underwater satellite wells which last year produced 30% of the crude oil brought to the surface in North America. Petrochem, which operates

the platform for a consortium of major energy corps, is sending security and investigation teams to the platform.

The “Hibernia” platform was constructed in the 1990s at a cost of some 20 billion eb. No immediate reason for the attack is known.

## RED FLAG ARMY TAKES CREDIT FOR HIBERNIA ATTACK

**Night City (AP)** – A news release from the Red Flag Army, a terrorist organization, has taken credit for the missile attack on the “Hibernia” production platform earlier today. A detailed description of the methods and equipment used to conduct the attack seems to leave no doubt that this shadowy group was responsible.

Petrochem officials had no comment on the Red Flag press release.

There have been persistent rumors that the Red Flag Army, while posing as a radical left terror group, is actually a mercenary corporate strike force.

## AMERICAN AND CANADIAN MANHUNT FOR HIBERNIA ATTACKERS

**St Johns, Newfoundland** – A joint American-Canadian law enforcement task force has been formed in the wake of the “Hibernia” platform attack today. Officials from the RCMP and the FBI announced the task force at a press conference in St. Johns, Newfoundland earlier this evening. Spokesperson Milton McCollum said, “Every resource will be brought to bear in order to find the perpetrators of this sneak attack. We already have solid evidence leading us to persons involved in the planning of the attack, and arrests are expected soon.” When asked about the participation of the Red

Flag Army in the attack, McCollum said, “Everyone knows that the Red Flag Army is just a cover for various corporate schemes. I doubt this is any different.”

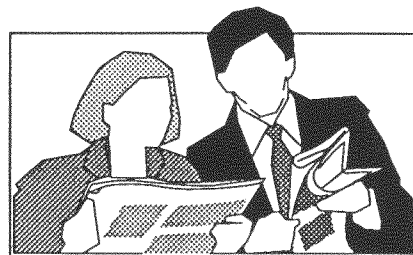

## CORPORATE REPORT

As of last download...EBM acquires Consolidated Factions by unfriendly takeover, analysts concerned...Leon H. Morgan III named VP of International sales for Genma Corp...WestTech stock falls due to chemical scare in South Indian Ocean...Petrochem under fire for alleged dumping in Texas facility...MetaLogical (pg. F-27)

## Entertainment AT CLUB RETRO



**FOR THE BEST INBIOSCUPT  
RECREATION AND CABARET.  
NOW APPEARING, "MORRISON  
LIVES!"**

**142 S.DELANY, NIGHT CITY**

## Scenario #7: **Stalking Horses**

### **Player Information:**

One fine day, one of the characters finds 1500 eb in an envelope with his or her name on it, left in his or her apartment, or in his or her car. No note, no explanation; must be someone who owes you money... yeah, that must be it.

A little later that day, you see a news scream about a bombing at the Hibernia oilfield — this means nothing to you (yet).

That evening, Federal, state, local, and Canadian cops are busting down your door, chasing your car, harassing your friends, and generally after you — they want to know what you had to do with the “Hibernia” platform bombing! It seems they “know” that a member of your group did the technical planning or research for the attack. You’d better be able to prove differently before they grab you and throw you into braindance.

Of course, that assumes that none of you *did* take part in the attack: how well do you know each other, anyway?

### **Ref's notes:**

The Red Flag Army was paid by SovOil to take the blame for the attack on the “Hibernia” platform. Red Flag turned around and spread the blame around a bit, by creating a ‘scenario’ for the attack. Choose one of the characters to be the “patsy” — preferably a Netrunner or Tech, possibly a Solo with a good leadership record or good reputation. This person was given the part of “the guy who checked their defenses/found and rigged the missile/planned the attack for us,” depending on the Role of the character. Various faked physical and electronic evidence has been

created to incriminate the character; depending on how careful and paranoid the character is, there may even be bits of wire, missile manuals, or flight path diagrams among his or her possessions.

The characters should have enough warning about the first “visit” by the cops to get away screaming AV-6s,

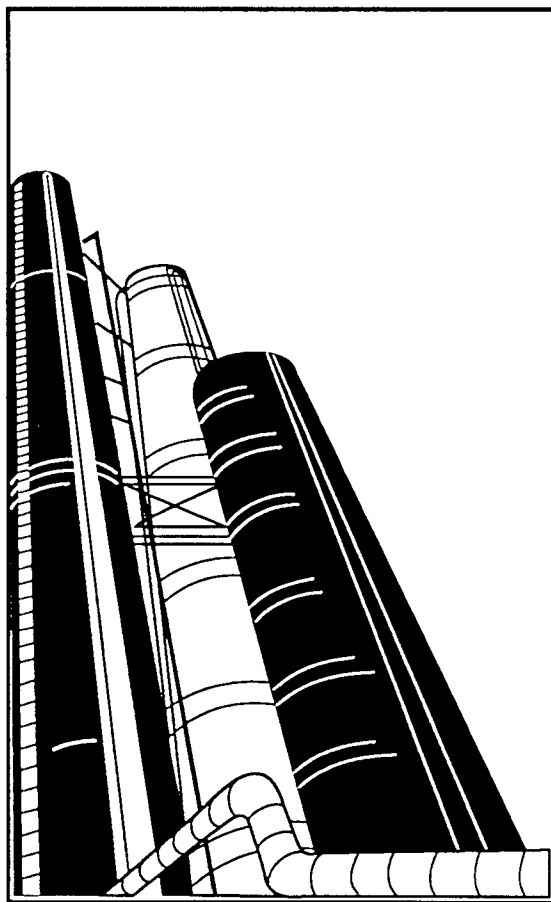

howling sirens, bullhorns, cops going “hup, hup, hup.” It should be played for major overkill by the ref. The cops are looking for the “patsy,” but will also pick up any other of his or her friends they can find.

There will be a continuing massive manhunt by uniformed cops for all of the characters; this, however, should not be too hard to avoid. The plainclothes detectives on their trail should be more of a worry.

In order to clear their names, the characters will have to find members of the Red Flag Army and lean on them, or follow them around to their “cell” bases, or some such. In the meantime banks will be shutting down the characters’ accounts, desk clerks at any but the cheapest hotels will have pictures of them taped behind the counters, and every slime-

ball on the street is being leaned on for information by undercover cops.

Engaging in shootouts with the cops is a good way to ensure your ticket gets punched, whether you find Red Flag or not.

### **Alternate version:**

would any of the characters be interested in checking the defenses/finding and rigging a missile/planning the attack for the Red Flag Army? They would have paid 1000 to 2000 eb for this kind of help. Of course, when you end up being chased by the cops later, because Red Flag ratted on you, there isn’t that glow of injured innocence about you.

# NIGHT CITY TODAY

November 10, 2020  
VOLUME CCVI, No. 35

## PEAK & DERRERA ANNOUNCES INCREASE IN PALLADIUM INVENTORY

**Night City (AP)** – In a startling announcement, Peak & Derrera announced today that they are expanding their palladium inventory to record highs, despite the recent slump in prices. Corporate spokesperson Jane Bean said, “We are confident that the latest catalyzed cold fusion experiments will result in breakeven energy production. When that happens, we expect palladium to be in great demand.”

P&D expects to receive the final shipments of palladium at their New York facility today, bringing their total inventory to over 110,000 troy ounces. Palladium for immediate delivery closed at 330 eb per troy ounce yesterday, down 2 eb; prices today are rising in reaction to the P&D announcement.

## Worst Winter In Over a Century In New York City *180 Deaths Reported*

**New York** – Massive snowfalls, and several nights where temperatures have dropped to 20° below zero, have created havoc in New York City. Nearly 3 feet of snow is on the ground, including 6” in the last 24 hours. Deaths directly attributable to the weather number 180, and city

officials privately expect to find many homeless people frozen to death in drifts. National Guard troops have been sent into the city to help with emergency services and maintain order. Traffic on all but a few major streets has come to a halt. All local airports have been closed, and the only aircraft moving are vectored thrust craft. Further snows are expected, and high winds of up to (cont'd page C-20).

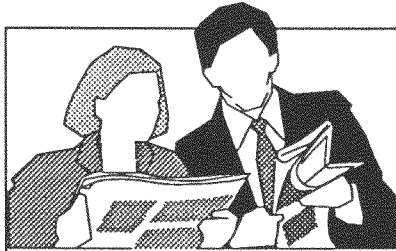

## CORPORATE REPORT

### PEAK & DERRERA

**Precious materials brokers**

**Main office:** Baltimore, MD; Regional Offices: New York, Los Angeles, Geneva, London, Tokyo

**Stock:** 111,500,760 shares;

**Available on Market:** 760,000 shares;

**Major Shareholders:** Penstone Equities, 8%; InterMutual Fund, 7%; Mr. Maxwell Orvis, 6%

**Troops:** 150 combat ready, all assigned as guards to offices or for shipments. Covert Operatives: 5

**Equipment and Resources:** P&D has some of the world's tightest security at their offices, and their Netrunners are top-notch. Valuable shipments are moved in convoys of at least 4 armed AV-6s, of which the company owns 30. Each office also has a corporate jet and helicopter for VIP transport. For long distance shipments, the company charters scramjets from various sources.

## BODY IMAGE

When only the Best will do...  
1-417-555-8900

## NEW BANK CLEARING CENTER NEARLY FINISHED

**Night City** – Construction of the new North American bank payment clearing center is almost completed, officials announced today. The CHIPS-II facility (Clearing House Interbank Payment System) will house computers to electronically move hundreds of trillions of eurobucks being transferred between banks each day. The computers, built by Cal Digital, will be among the largest and fastest ever installed in commercial service.

The facility is expected to begin testing in 6 months, and should be in full operation by next summer. The building itself is being constructed by Perkins/Worldwide Contractors.

## BANKING LOSSES TO ELECTRONIC THEFT REACH ALL TIME HIGH

**Washington** – Federal Reserve officials revealed today that last year American banks lost over 400 million eurobucks to computer infiltration and electronic credit fraud. This represents a real increase, adjusted for inflation, of 5% over 2012. The Federal government has identified interbank payment procedures, customer identification, and corporate indifference as major problems (continued on page C-49)

**HELP WANTED:** CONCRETE PUDDLERS, MIXER OPERATORS, SHEET METAL WORKERS, ELECTRICAL INSTALLERS, AND ALL CONSTRUCTION TRADES WORKERS:

Perkins/Worldwide Contractors has several major projects underway in NYC, and we need qualified craftsmen to do the job. Wages are competitive with union jobs, and unmatched benefit package assures you of on-the-job protection. Call 1-910-555-1900 for an application. PERKINS/WORLDWIDE NEEDS YOUR SKILLS!

## Scenario #8: **Things Done Proper**

### **Player Information:**

The team has been recruited to take part in a big-time crime: robbing the Peak & Derrera vaults in New York City.

Your boss is a fixer named John "Sonny" Altaro, and seems to have lots of contacts with "traditional" organized crime figures. The way the cut goes is this: 40% to the guys fencing the metal, 20% to Altaro, 10% to bribes for some unnamed P&D personnel providing assistance, and the other 30% to the team. Altaro has detailed maps of the physical and electronic security of the P&D building, and a few of the less important passwords. Altaro can also obtain all sorts of illegal equipment at cost. Up to 200,000 eb can be spent ahead of time to get this mission off the ground.

The actual recruitment occurs about 1 week before the palladium hits the vaults. The upcoming lousy weather is being predicted quite accurately at that point. Once the palladium is in the vaults, the company will wait till after the foul weather is over to disperse the metal to all of its other offices. Thus, the team will have a window of three to five days to do the job.

As a possible useful piece of information, snowmobiles cost about 2500 eb, can carry two people, and can tow a sledge carrying 250 kg at 25 mph. Unloaded, the snowmobiles can hit 45 mph.

### **Ref's notes:**

This should be run like a "crime thriller/bank heist" movie. People in coveralls with hands-off microphones crouched over equipment in back of unmarked vehicles, surveillance

teams in parkas placing remote cameras on adjacent rooftops, techs disguised as phone company employees sneaking into the local exchanges, and a lot of thorough planning.

The palladium itself is kept in a large vault in the basement of the P&D building; an elevator big enough to hold an AV-6 leads from the roof to the basement, stopping directly in front of the vault door. There are half a dozen electric forklifts in the basement; each can lift 500 kg. The palladium is in locked metal boxes sitting on the floor of the vault, 4000 troy ounces to a box. It is easily identified. All other precious metals in the vault are stored in locked, armored trays along the walls; blowing all of these would be very time consuming, and is probably not worth the trouble.

If the team picks the right day, even vectored thrust vehicles should have difficulty flying.

There are 10 armed and armored guards on duty at any time, and 10 sleeping out of armor in a small bunkroom in the basement. Only 2 other employees, a company exec and a secretary to answer phones, are here during the 2 worst days of the storm. Routine phone traffic is being routed to the company head office in Baltimore.

If an alarm signal reaches the police, a few squad cars will come sliding along the street within 5 or 10 minutes; it will take 20 minutes for the Tactical Squad to get here.

## Scenario #9:

## **Spy Wednesday**

### **Player Information:**

The characters are approached by a well-known netrunner (well known to other netrunners, anyway). He will offer them 2000 eb a month to get jobs at the CHIPS-II site and install a few little "black boxes" for him. Most can be embedded in concrete with just their antenna "tails" near the outer surface; some he would like more obtrusively placed, in ductwork or on phone lines. A couple of these boxes a week, for a month or two, that's all he needs to get a handle on the national money markets.

### **Ref's notes:**

Security is pretty tight at the CHIPS-II jobsite, and a couple of the higher-ups in security remember what happened to the new American Embassy in Moscow in the 1980s. Characters on the job will not be wearing body armor, or carrying any but the smallest of weapons; the guards, on the other hand, wear armor vests, helmets, and carry shotguns.





# NIGHT CITY TODAY

November 17, 2020  
VOLUME CCVI, No. 36

>CRIME

>WALLENSTEIN: CURRENT: DENVER

## TOP INFOCOMP RESEARCHER GONE MISSING

Dr. Harold N. Wallenstein, a prominent information theory researcher employed by Infocomp, is currently the object of a massive search being undertaken by Infocomp and various police agencies. Dr. Wallenstein, age 40, disappeared 3 days ago during a fire at the Infocomp facility in Denver where he is employed. Arson investigators believe the fire to have been set deliberately.

Wallenstein, in his six years employment with Infocomp, has contributed greatly to the efficiency with which the corporate data base is (continued page C-22)

>BUSINESS

>EBM

>DATA/RESEARCH

>RECENT: CURRENT:

HAMBURG/MARSEILLES

## EBM Announces New Data Facility

**Marseilles** – Euro Business Machines Corp. issued a press release describing a new corporate data management center at Marseilles, France. Spokesperson Andrew Fenner said the center had been constructed at a cost of 150 million eb. "EBM has gone to great lengths to build and equip this facility, and we intend to challenge Infocomp, Rand, and NipponData for the corpo-

rate data base market. Top-flight researchers, using EBM's cutting-edge hardware, will be able to (cont'd pg. C-2)

>EBMFACILITIES

>MOUNTAIN STATES

>RECENT: 2 WEEKS:

LAS VEGAS NM

## EBM EXERCISES TO BE HELD AT SANGER LABS

**Las Vega** – Sanger Labs, a local subsidiary of EBM, is conducting a test of their defensive arrangements for the next three weeks or so. Corporate spokespersons emphasized that all of the training would take place within the boundaries of the 2400 acre facility, and that there would be no danger to the public. "Realistic tests and training are necessary in order to be defensively prepared for possible sabotage or infiltration attempts," said a spokesperson.

Sanger Labs employs nearly 200 people, of whom about 20 have been hired in this county. County officials, when contacted about the corporate live fire exercise, had no comment.

>SANGER LABS

>DEFENSE: 2 YEARS:

LAS VEGAS NM

## FEDS APPROVE LAB DEFENSES

The BATF today issued a license to Sanger Labs for their proposed defensive armament. The decision, while not unexpected, did not please the San Miguel county board of supervisors, who had contested Sanger's application. Board president Tyler Powell announced that an appeal would immediately be filed with the Justice Department.

The BATF decision allows Sanger to post up to 30 heavily armed guards, and 2 armed scout helicopters. "Non-lethal" defenses, such as electrified barbed tape, sensors, and tripflares are already in place at the facility, located east of Las Vegas at the former Rocking R Ranch.

>LAS VEGAS NM

>WEATHER

>CURRENT: CURRENT:

## WEATHER TODAY

Heavy overcast and low temperatures are predicted for northern New Mexico this weekend. Temperatures should range from daytime highs in the 40s, to nighttime lows in the 30s. Expect more snow at higher elevations. Pollutants index stands at 380: no special protection needed.

Next week promises better weather, with clearing skies and higher temperatures.

Heavy hail was reported Wednesday at Durango, CO; some damage to property (continued on pg. C-4)

>UH-90

>PERFORMANCE SUMMARY:

## EYE ON THE MARKET:

### *Night City Today* Examines the Best in Available Equipment Today: the UH-90

Utility/squad transport helicopter, powered by Allison T800 turboshaft; fully integrated cockpit with inertial/GPS worldwide nav capability, all-weather and thermal imaging systems, NOE capable autopilot (supported by APQ-800 terrain following radar), radar warning receivers, infra-red jammer, hardened avionics, TI "pilot's assistant" expert flight management system. Cruise speed 280 kph, top speed 325 kph, endurance 7 hours, max. range 2000 km (with ferry tanks), rate of climb 2.5 m/sec; 2 pilots' positions, 6 crashworthy troop seats, can carry 8 total passengers. Interior can be sealed; complete NBC filters are provided. Empty weight 1400 kg, max. loaded weight 3800 kg, max. internal fuel 2000 liters; can mount two 350 liter external tanks for ferry flights. Three armament fixture points are provided: nose, and port/starboard side pylon mounts.

For our performance tests, we took the UH-90 to China Lake, in the Mojave Desert. There, we put the craft through (cont'd on page C-9)

## BODY IMAGE

When only the Best will do...

1-417-555-8900

## Scenario #10: **Deniably Plausible Strike**

### **Player Information:**

Infocomp is looking for a team to attempt a counter-extraction. They believe Dr. Harold Wallenstein, an information theory specialist, was extracted from their Denver office by an EBM team, and is currently at Sanger Labs, east of Las Vegas, New Mexico, being prepared (with bodysculpting and other techniques) for an imminent re-appearance (under another name, of course) at EBM's new Marseilles facility. Within a couple of days EBM will probably fly Wallenstein by AV-4 to Albuquerque, and then by corporate scramjet to France.

Infocomp is offering 15,000 eb up front for the recovery, plus a success bonus of 15,000 eb. These figures cover the whole team. If the team wants more up front for expenses, they will have to convince Infocomp that they have a viable plan, and justify any extra equipment. Dr. Wallenstein should be delivered alive and reasonably healthy to the Infocomp facility in Denver.

At least one member of the team should have a good Med-Tech skill, and be equipped to keep Dr. Wallenstein alive in case he is wounded, or (possibly) booby trapped. Otherwise team composition is unimportant.

Orbital imaging of the Sanger Labs site shows a main building, 3 stories tall, covering 10,000 square meters of ground; a hangar/garage, covering 1,000 square meters of ground, and a lot of corporate landscaping in the immediate area; all covered by a few inches of snow. The perimeter of the site is a rough rectangle about 3000 meters on a side. There are a few trees and bushes in the landscaped area; other than that, low scrub and bare flat ground predominate. The nearest hills are to the north and south, respectively 5000 meters and 3000 meters away from the center of the site. The two lane, paved access road leads west towards Las Vegas. There has been no traffic on this road for the past two days.

Intrusion sensors have been scattered about the site by EBM; their capabilities are unknown.

Foot patrols are being conducted on the site, by guards in pairs. They are in constant radio communication, using secure channels, with the security office in the main building. Usually 2 pairs of guards will have this duty. IR imaging gear is almost certainly being worn by these guards.

It is known that 2 helicopters are present at the site; one is kept in the hangar, and the other on pad alert with the crew aboard. After observing several reaction flights from orbit, it has been determined that no more than 15 seconds elapse between the issuance of flight orders from the security office and the launch of the chopper. The choppers are UH-90s, armed with nose-mounted 25mm chain guns. At least one 4-man security squad is kept ready to ride in the choppers on occasion.

It is believed that the Sanger Labs site is operating under "security lockdown" conditions at the moment. Several locally-hired employees, who normally do custodial and maintenance work at the labs, have been called and told to take a paid vacation for a week or two. These persons, if contacted, might be able to provide information about the internal layout of the labs, and their security procedures.

The Sanger Labs facility has almost certainly been equipped with NBC filters and sensors, to prevent intruders from spreading gas agents through the ductwork.

Infocomp will provide materials to identify Dr. Wallenstein, if his appearance has not changed too much.

### **Ref's notes:**

This is going to be a tough one. The 30 heavily armed guards, tripflares, sensors, and helicopters are all there, just like the screamsheet says. In addition, a top Eurosolo, Marc Dumouline, has been sent to "supervise" the whole affair. In three days, Dr. Wallenstein will be flown to France.

Normally, 4 of the guards are patrolling outside, 4 are in full kit as a "reaction force," 1 is on duty at the entrance lobby, 1 stands guard out-

side Dr. Wallenstein's room, and another 5 patrol the main building. The other 30 are off-duty, but Dumouline insists they sleep in combat gear and keep their weapons handy. The hangar contains another UH-90 (which would take 30 seconds to prepare for flight), and two vans.

In the security office 7 techs monitor cameras and alarms, while a netrunner, Seagull, monitors the EBM System 1300 computer which the lab uses. Dumouline will always be in the security office, unless the players' team is detected in or near the main building, in which case he will proceed to the med section.

A single Stinger-POST III shoulder fired anti-aircraft missile launcher (75% chance to hit within 5000 meters, IR and optically seeking) is available to the defenders.

Dr. Wallenstein is in the medical section on the second floor, and is recovering from cosmetic surgery. He is the only patient in the med section (so identifying him should be no problem, despite his new face and fingerprints). He is in no condition to move, being heavily sedated. He is a bit overweight (105 kg). There are, however, a wheelchair and gurneys immediately available in the med section. He has not been booby-trapped (unless the referee is being unusually cruel).

The other 150 or so people in the building have no interest in being involved in combat. If persuaded or intimidated to talk before the mission, several of the locally hired janitors (currently at loose ends) can sketch rough maps of the site, and describe ordinary (pre-Dr. Wallenstein) security procedures. None of these people have seen Dumouline.

The day Dr. Wallenstein is to leave, an EBM corporate scramjet, 4 armed AV-4s, and several vans with a total of 25 EBM troops will arrive at the Albuquerque airport early in the morning. Three of the AV-4s will then fly to the Sanger Lab facility, pick up Dr. Wallenstein and Dumouline, and return to the airport. The AV-4s take about 20 minutes to get from Albuquerque to the lab site, and one of them will spend about 60 seconds on the ground at the lab.



# CYBERPUNK™

## THE ROLEPLAYING GAME OF THE DARK FUTURE

*The Corporations control the world from their skyscraper fortresses, enforcing their rule with armies of cyborg assassins. On the Street, Boostergangs roam a shattered urban wilderness, killing and looting. The rest of the world is a perpetual party, as fashion-model beautiful techies rub biosculpt jobs with battle armored roadwarriors in the hottest clubs, sleaziest bars and meanest streets this side of the Postholocaust. The Future never looked so bad.*

*But you can change it. You've got interface plugs in your wrists, weapons in your arms, lasers in your eyes, bio-chip programs screaming in your brain. You're wired in, cyberenhanced and solid state as you take it to the fatal Edge where only the toughest and the coolest can go. **Because you're CYBERPUNK.***

***CYBERPUNK: the original roleplaying game of the dark future; a world of corporate assassins, heavy-metal heroes and brain burning cyberhackers, packed with cutting edge technology and intense urban action. Within this box, you'll find everything you need to tackle the mean streets of the 2000's— in a game system that combines the best in realistic action and playability.***

### FEATURING:

***Rockerboys: Hard-rock heroes fighting for change with music & revolution!***  
***Solos: Corporate cybersoldiers— more machines than men!***  
***Netrunners: Superhot hackers who can crack any Data Fortress!***  
***Medias: Hightech reporters going to the wall to get the truth!***  
***Nomads: Cyberbiking renegades cruisin' the lethal hghways of the Postholocaust!***  
***Corporates: Slick business raiders playing the deadly corporate power game!***  
***Techies: Masters of cybernetics in the heavy-metal age!***  
***Fixers: Streetsmart middlemen who know all the angles!***  
***Cops: Maximum lawmen in the big-city jungle!***



**2. THE SECOND EDITION 2.**

**R. TALSORIAN  
GAMES  
INC.**

P.O. Box 7356, Berkeley, CA USA 94706

CP 3002 ISBN 0-937-279-13-7

Featuring: New Cybernetics • New Weapons • Streamlined  
Combat • New Technology • Advanced Netrunning • Night  
City Guide

Compatible with Cyberpunk 1.0

\$22.00 U.S.